

User's Manual

**ICS-100 / ICS-101 / ICS-102
ICS-102S15 / ICS-105A**

**RS-232/RS-422/RS-485
over
100Base-FX / 10/100Base-TX
Media Converter**



Trademarks

Copyright © PLANET Technology Corp. 2012.

Contents subject to which revision without prior notice.

PLANET is a registered trademark of PLANET Technology Corp. All other trademarks belong to their respective owners.

Disclaimer

PLANET Technology does not warrant that the hardware will work properly in all environments and applications, and makes no warranty and representation, either implied or expressed, with respect to the quality, performance, merchantability, or fitness for a particular purpose.

PLANET has made every effort to ensure that this User's Manual is accurate; PLANET disclaims liability for any inaccuracies or omissions that may have occurred.

Information in this User's Manual is subject to change without notice and does not represent a commitment on the part of PLANET. PLANET assumes no responsibility for any inaccuracies that may be contained in this User's Manual. PLANET makes no commitment to update or keep current the information in this User's Manual, and reserves the right to make improvements to this User's Manual and/or to the products described in this User's Manual, at any time without notice.

If you find information in this manual that is incorrect, misleading, or incomplete, we would appreciate your comments and suggestions.

FCC Warning

This equipment has been tested and found to comply with the limits for a Class B digital device, pursuant to Part 15 of the FCC Rules. These limits are designed to provide reasonable protection against harmful interference when the equipment is operated in a commercial environment. This equipment generates, uses, and can radiate radio frequency energy and, if not installed and used in accordance with the Instruction manual, may cause harmful interference to radio communications. Operation of this equipment in a residential area is likely to cause harmful interference in which case the user will be required to correct the interference at whose own expense.

CE Mark Warning

This is a Class A product. In a domestic environment, this product may cause radio interference, in which case the user may be required to take adequate measures.

Energy Saving Note of the Device

This power required device does not support Standby mode operation.

For energy saving, please remove the DC-plug or push the hardware Power Switch to OFF position to disconnect the device from the power circuit.

Without removing the DC-plug or switch off the device, the device will still consume power from the power source. In the view of Saving the Energy and reduce the unnecessary power consuming, it is strongly suggested to power off or to remove the DC-plug for the device if this device is not intended to be active.

WEEE Warning



To avoid the potential effects on the environment and human health as a result of the presence of hazardous substances in electrical and electronic equipment, end users of electrical and electronic equipment should understand the meaning of the crossed-out wheeled bin symbol. Do not dispose of WEEE as unsorted municipal waste and have to collect such WEEE separately.

Revision

PLANET RS-232/RS-422/RS-485 over 10/100Base-TX/100Base-FX Media Converter User's Manual

FOR MODELS: ICS-100 / ICS-101 / ICS-102 / ICS-102S15 / ICS-105A

REVISION: 1.5 (APRIL.2012)

Part No.: 2080-AA3600-005

TABLE OF CONTENTS

1. INTRODUCTION	1
1.1 PACKAGE CONTENTS	1
1.2 HOW TO USE THIS MANUAL	1
1.3 PRODUCT DESCRIPTION	2
1.4 APPLICATIONS	2
1.5 PRODUCT FEATURES	4
1.6 PRODUCT SPECIFICATION	5
2. INSTALLATION	7
2.1 HARDWARE DESCRIPTION	7
2.1.1 Product Layout	7
2.1.2 LED Indicators	11
2.1.3 DB9 Pin Define	11
2.1.4 ICS-10X Rear Panel	12
2.2 INSTALL THE CONVERTER	12
2.2.1 Stand-alone Installation	12
2.2.2 Chassis Installation and Rack Mounting	14
3. MANAGEMENT	16
3.1 OVERVIEW	16
3.2 REQUIREMENTS	16
3.3 MANAGEMENT METHODS	17
3.3.1 Web Management	17
3.3.2 Login the Media converter	17
4. WEB CONFIGURATION	19
4.1 MAIN MENU	19
4.2 SYSTEM	20
4.2.1 System Information	20
4.2.2 Password Setting	21
4.2.3 Firmware Upgrade	22
4.2.4 Factory Default	24
4.2.5 System Reboot	24
4.3 NETWORK CONFIGURATION	25
4.4 OPERATION MODE	26
4.4.1 TCP Server Mode	27
4.4.2 TCP Client Mode	32
4.4.3 UDP Client Mode	33
4.4.4 Virtual COM Mode	34
4.4.5 Telnet Server Mode	42
4.4.6 Pair Connection– Local Mode	47
4.4.7 Pair Connection – Remote Mode	48

4.5 SERIAL PORT CONFIGURATION	52
4.6 SMTP.....	54
5. SOFTWARE VCOM UTILITY.....	57
5.1 INSTALLING THE VCOM UTILITY	57
5.2 SEARCH THE DEVICE.....	60
5.3 VIRTUAL COM.....	61
APPENDIX A.....	64
A.1 PLANET SMART DISCOVERY UTILITY	64
A.2 DEVICE'S RS-232/RS-422/RS-485 PIN ASSIGNMENTS	65
A.3 DEVICE'S RJ-45 PIN ASSIGNMENTS	65
A.4 RJ-45 CABLE PIN ASSIGNMENT	66
A.5 FIBER OPTICAL CABLE CONNECTION PARAMETER.....	67
A.6 POWER INFORMATION.....	67

1. INTRODUCTION

Thank you for purchasing PLANET Serial over Fast Ethernet Media Converter – ICS-10x series. Terms of “Serial Media Converter” means the products mentioned titled in the cover page of this User's manual

1.1 Package Contents

Open the box of the Serial Media Converter and carefully unpack it. The box should contain the following items:

Check the contents of your package for following parts:

- **Serial Media Converter x1**
- **CD-ROM User's Manual x1**
- **Quick Installation Guide x1**
- **External 5VDC / 2A Power Adapter x 1**

If any of these are missing or damaged, please contact your dealer immediately, if possible, retain the carton including the original packing material, and use them against to repack the product in case there is a need to return it to us for repair.

1.2 How to Use This Manual

This Media Converter User Manual is structured as follows:

- **Section 2, Installation**
It explains the functions of ICS-10x and how to physically install the ICS-10x.
- **Section 3, Management**
The chapter explains how to manage the converter by Web interface.
- **Section 4, Web Configuration**
It contains information about the Smart function of ICS-10x.
- **Section 5, Software VCOM Utility**
It explains the software VCOM how to use with the operation Virtual COM.
- **Appendix A**
It contains cable and Smart Discovery utility information of ICS-10x.

1.3 Product Description

The **Web-Smart ICS-10x** series Media Converter / Device Server provide to converts **Serial RS-232 / RS-422 / RS-485 communication interface over Fast Ethernet networking**. There are RJ-45/SC/LC connectors and single-mode/multi-mode media for your needs. Ethernet signal that allows two types of segments to connect easily, efficiently and inexpensively. This converter can be used as a stand-alone unit or as a slide-in module to the PLANET Media Converter Chassis (**MC-700, MC-1500 and MC-1500R**). It's time saving expense for user and SI, no need to replace the existing Serial equipment and software system.

It extends the distance of deploying Serial equipments and hosts. The selectable fiber-Optic wires on the basis of distance are flexibly provided. Therefore, this product will perfectly satisfy the diverse demands while providing reliable and efficient network solutions based on the distance and budgets of installation.

The ICS-10x make connected Serial equipment becomes IP-based. That also makes them be able to connect to a TCP/IP networking immediately. Each Web-Smart converter is able to manage through the Web Interface. The powerful Web-Smart Media Converter supports Application mode, Serial operation mode connect alarm and IP address, etc. Management function helps reduce the amount of valuable time that a network administrator spends detecting and locating network problems, otherwise it requires visual inspection of cabling and equipment. Multiple connection options for large networking environment are available as well.

1.4 Applications

Access Control System – Traditional Installation

Most of the enterprise and government use access control plate and Mifare or RFID to authorize the entrance identity. With traditional deploy, access control machine use RS-232 or RS-485 serial interface and cables connect to login server. With connection to ICS-10x Serial over Fast Ethernet Converter, the access control machine is able to be extend over longer distances via fiber optical interface. Or the ICS-10x can be linked to a xDSL router to get the internet access capability; the access control can be set and monitored over the internet.

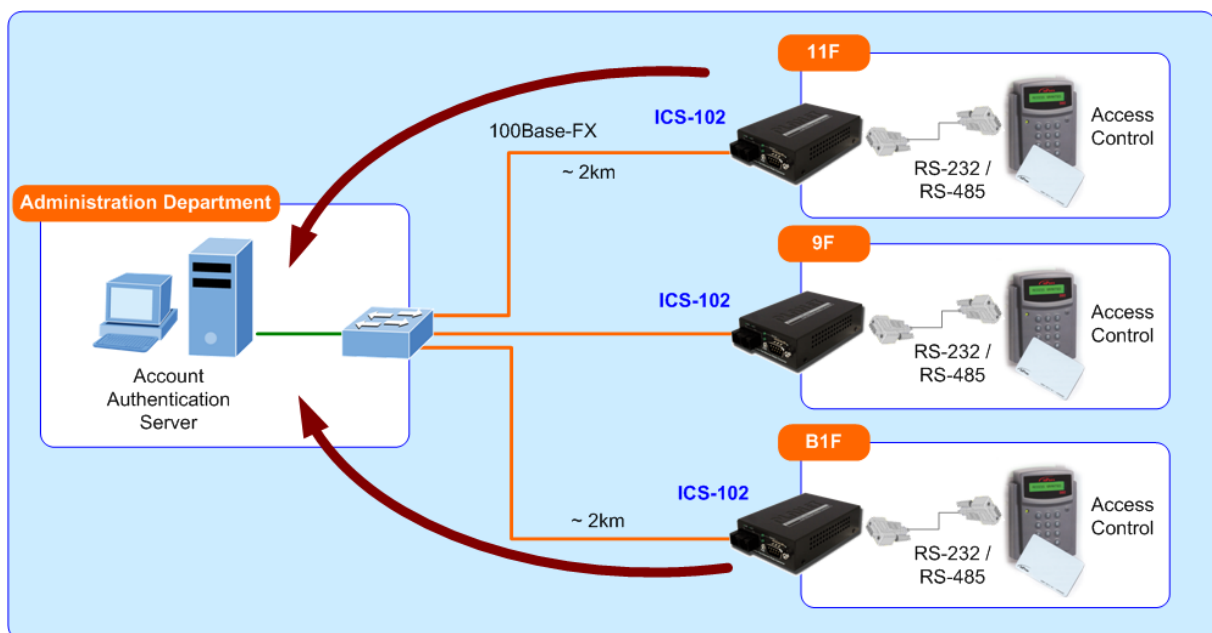

Figure 1-1 Serial Converter for Access Control System Application

Process Control

To monitor, configure and manage the Robot conveyer including other machines in a manufacturing, PLC (Programmable Logical Control) is required. The PLC is used to drive above the manufacturing machines process. The ICS-10x can be set to TCP Server mode and connect the PLC. The administrator can configure and set command settings through Fast Ethernet intranet to control the PLC, the administrator and workstation. There is no need to be always sets by the side of the I/O machine.

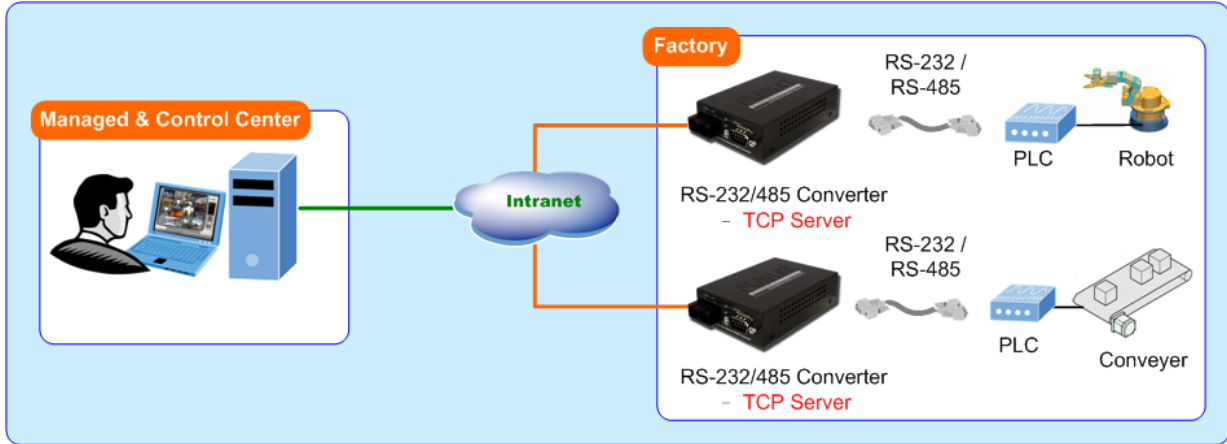

Figure 1-2 Serial Converter for Factory PLC Application

RTU Data Collect – UDP Mode

Connect with RTU (Remote Terminal Unit) to collect and monitor the data of waves, signal and power utilization. ICS-10x can be used to set-up UDP mode and send data over Fast Ethernet to Local server or over internet to remote server automatically.

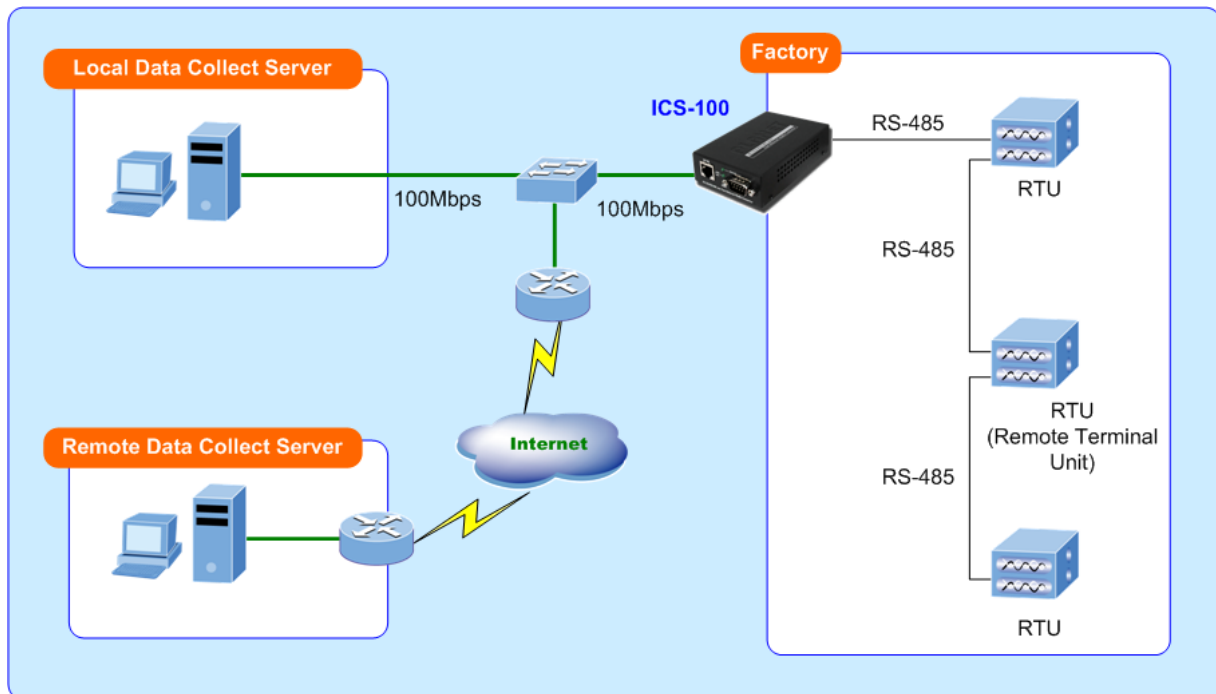

Figure 1-3 Serial Converter for Factory RTU Application

Surveillance Motion Control – Pair Connection Mode

Using pair connection along with fiber optical patch cord, the ICS-10x extend RS-232/RS-485 interfaces distance from surveillance and scanner to the control keyboard/joystick which is installed in the remote monitor center.

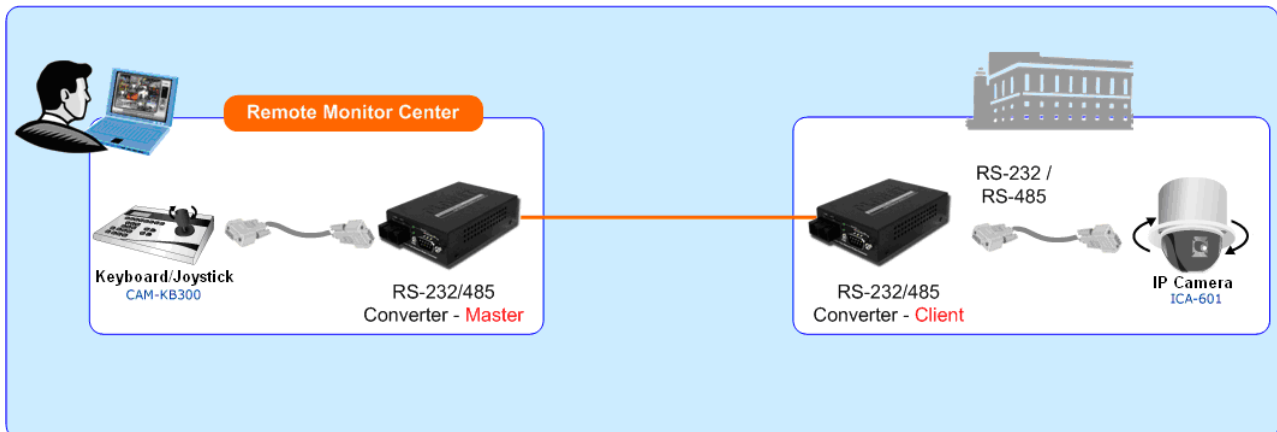

Figure 1-4 Serial Converter for Distance Extend Application

1.5 Product Features

Serial Interface

- One **RS-232/422/485** port to one **10/100Base-TX** or **100Base-FX** Media Converter
- Cost effective solution for RS-232 to Ethernet application
- Supports RS-232, 4-wire RS-422 or 2/4-wire RS485 operation
- Asynchronous serial data rates up to 921600b/s

Ethernet Interface

- Complies with IEEE 802.3, IEEE 802.3u 10/100Base-TX, 100Base-FX standard
- Supports auto MDI/MDI-X function on RJ-45 Port
- Choice of fiber-connector from ST / SC / LC, multi-mode / single-mode fiber

Smart Functions

- Standard TCP/IP interface and versatile operation modes
- Software Protocol Support ARP, ICMP, TCP/IP, UDP, HTTP server, DHCP client, Telnet server/client
- Built-in IP-Base **Web interface** for remote management
- Serial Operation mode selected via Web management
- Pair Connection mode for connecting two serial devices over a network
- PLANET Smart Discovery utility automatically finds xxx devices on the network
- Firmware upgrade via HTTP protocol

Hardware

- Compact size for easy Installation:
 - Standalone - Wall mountable or DIN-Rail mounting (Optional accessory)
 - Co-work with PLANET MC family Media Chassis (**MC-700/1500/1500R**)

- LED indicators for easy network diagnose
- Reset Button at the front panel for reset to factory default

1.6 PRODUCT SPECIFICATION

Products		ICS-100	ICS-101	ICS-102	ICS-102S15	ICS-105A
Hardware Specification						
Serial Port	Interface	RS-232 / RS-422 / RS-485				
	Connector	3-in-1 DB9				
	Baud rate	300 to 921600bps				
	Character Bits	5,6,7,8				
	Parity type	1, 1.5/2				
	Stop Bit	Odd, Even, None, Space, Mark				
	Flow Control	H/W, None				
	Signals	RS-232: TxD, RxD, RTS, CTS, DTR, DSR, DCD, GND RS-422: Tx+, Tx-, Rx+, Rx-, GND RS-485 (2-wire): Data+, Data- RS-485 (4-wire): Tx+, Tx-, Rx+, Rx-				
Ethernet Port	Standard	IEEE 802.3 Ethernet ,10Bas-T IEEE 802.3u Fast Ethernet, 10/100Base-TX, 100Base-FX				
	Connector	RJ-45	ST	SC		LC
	Fiber Mode	-	Multi-Mode		Single-Mode	Single-Mode Multi-Mode
	Transmission Mode	Full-Duplex / Half-Duple	Full-Duplex			
	Distance	100m	2km	15km	Depend of SFP module	
	Optical Wavelength	-	1300nm	1310nm	Depend of SFP module	
Cable	Twisted-pair	50/125μm or 62.5/125μm multi-mode fiber cable		9/125μm single-mode cable	50 or 62.5/125μm multi-mode fiber cable 9/125μm single-mode cable	
Protection	Built-in 1.5KV magnetic isolation					
LED Indicators	System: Power TP or Fiber Port: Link / Active Serial Port: Link / Active					
Management	Web Management PLANET VCOM Utility PLANET Smart Discovery Utility					
Operation Mode	TCP Server TCP Client UDP Client Virtual COM Telnet Server Pair Connection – Remote (Slave) Pair Connection – Local (Master)					

Dimension (W x D x H)	97 x 70 x 26mm
Weight	200g
Power Supply	External Power Adaptor 5V DC / 2A max.
Power Consumption	5.5 Watts (maximum)
Mechanical	Metal
Environment	Operating Temperature: 0~50 Degree C Storage Temperature: -10~70 Degree C Humidity: 10%~90% RH (operating) 5%~90% RH (Storage)
Emissions	FCC Class A, CE Certification
Standards	IEEE 802.3 Ethernet, 10Base-T IEEE 802.3u Fast Ethernet, 100Base-TX / 100Base-FX EIA/TIA RS-232/422/485
Regulatory Approval	RoHS
Compatible Media Converter Chassis	MC-700 / 1500 / 1500R
Note.	Reset Button at the rear panel for reset to factory default

2. INSTALLATION

This section describes the hardware features and installation of the ICS-10x's components on the desktop or shelf. For easier management and control of the ICS-10x, familiarize yourself with its display indicators, and ports. Front panel illustrations in this chapter display the unit LED indicators. Before connecting any network device to the Serial Media Converter, please read this chapter completely.

2.1 Hardware Description

2.1.1 Product Layout

Figure 2-1 to Figure 2-6 shows layout and front panel of ICS-10x.

- **ICS-100** – RS-232 / RS-422 / RS-485 over 10/100Base-TX

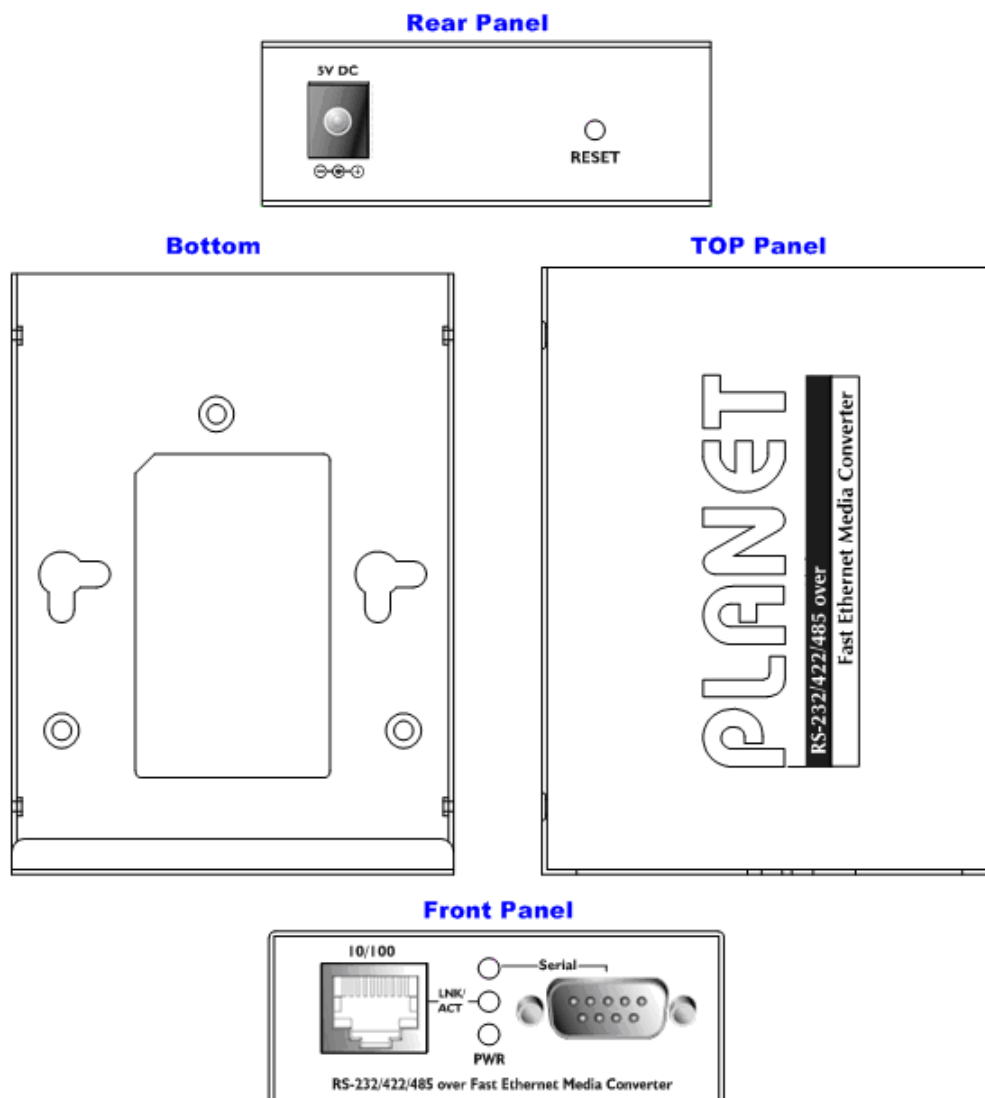

Figure 2-1 ICS-100 panel layout

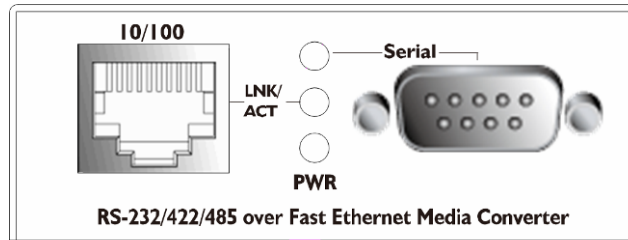

Figure 2-2 PLANET ICS-100 Front Panel

- **ICS-101** – RS-232 / RS-422 / RS-485 over 100Base-FX (ST Interface)

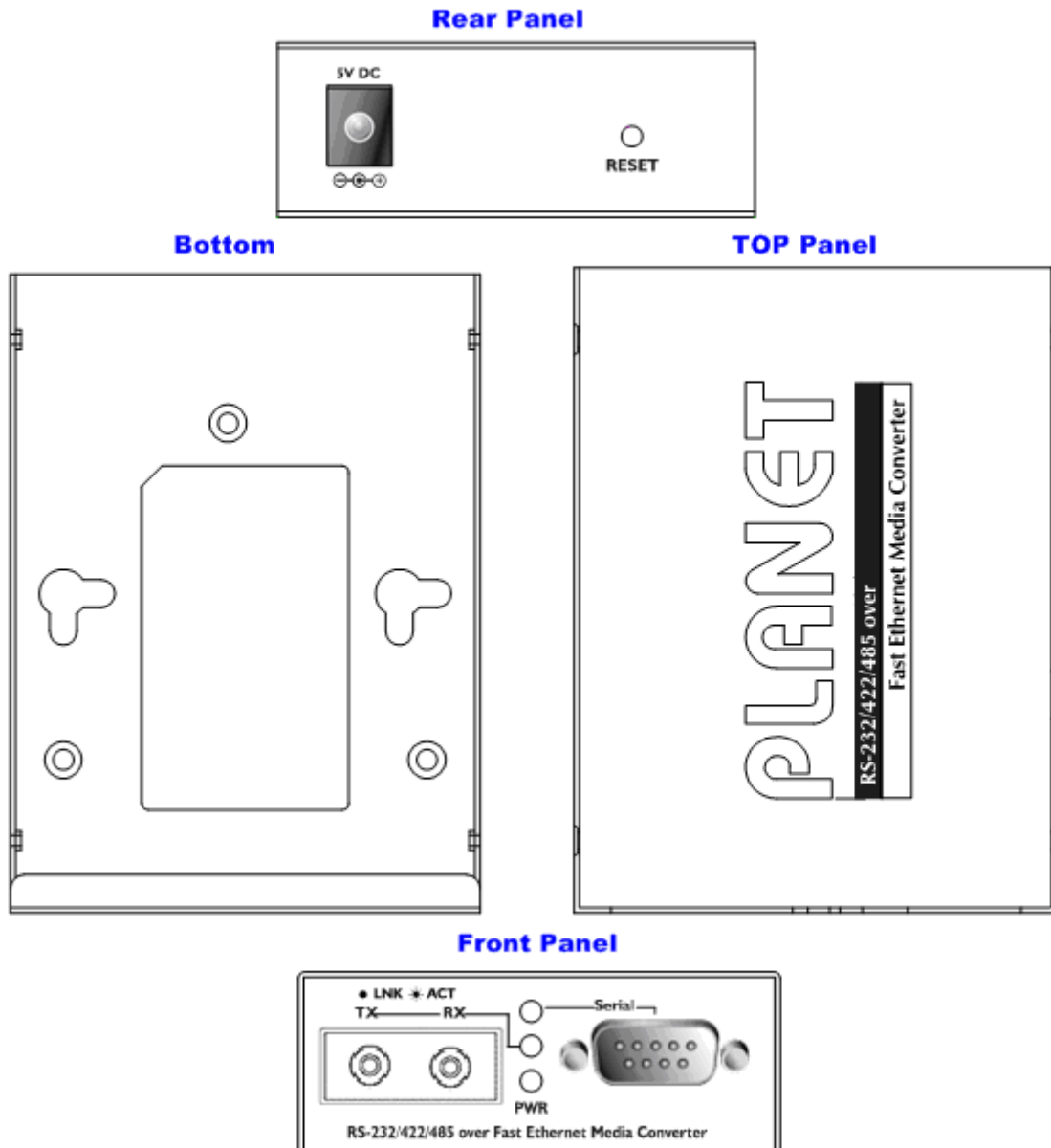

Figure 2-3 ICS-101 panel layout

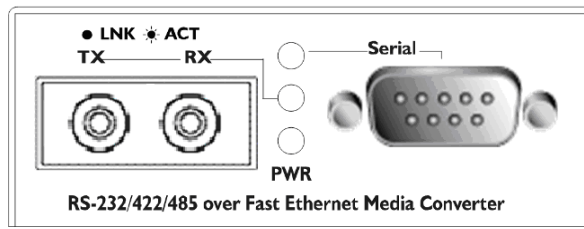

Figure 2-4 PLANET ICS-101 Front Panel

- **ICS-102 / ICS-102S15** RS-232 / RS-422 / RS-485 over 100Base-FX (SC Interface)

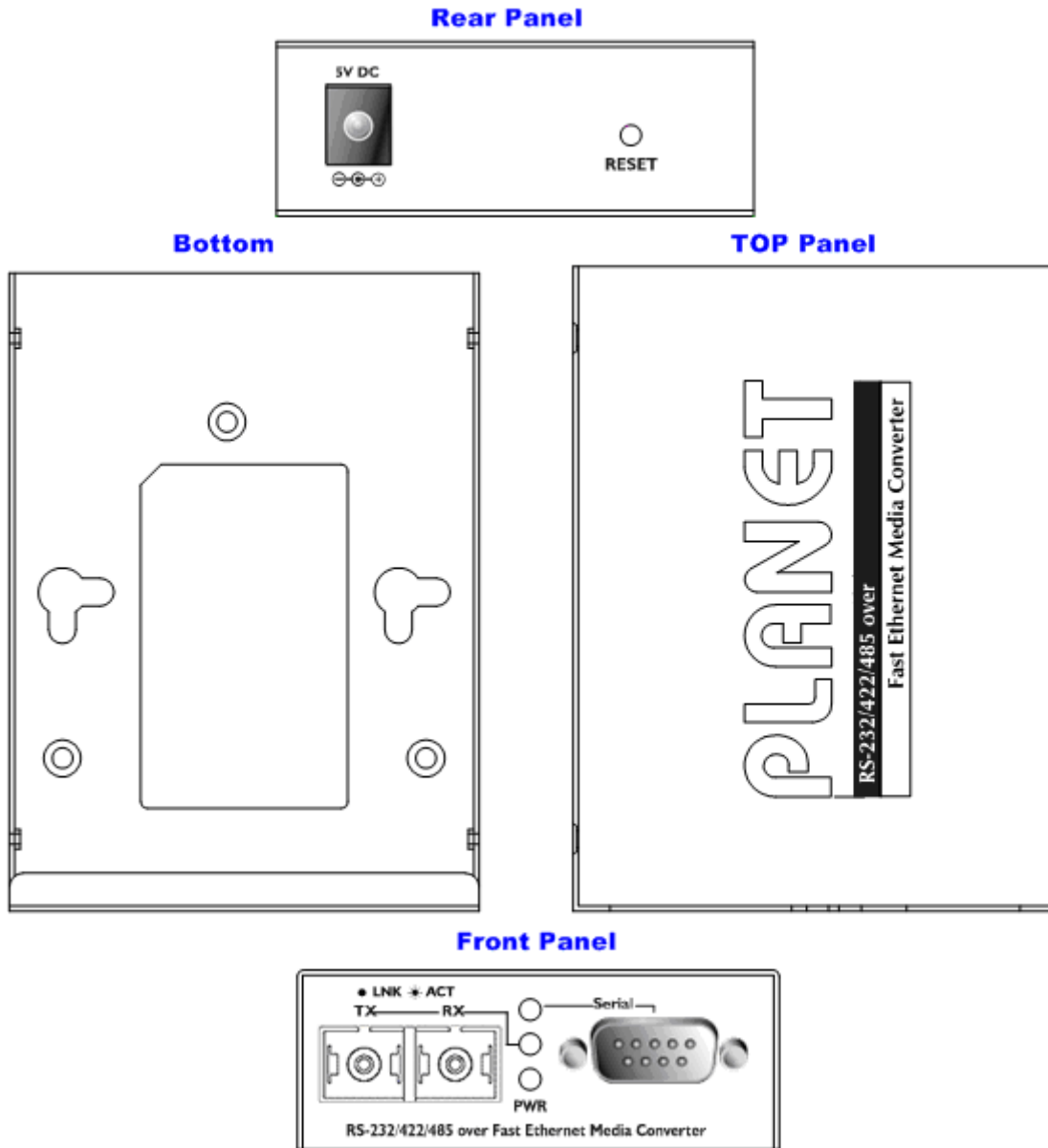

Figure 2-5 ICS-102 / ICS-102S15 panel layout

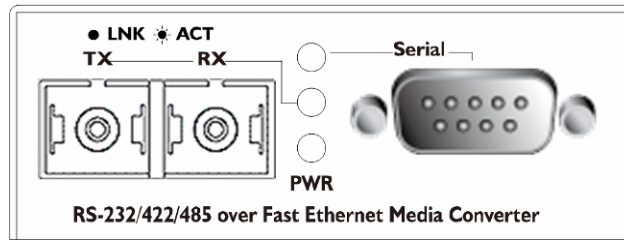

Figure 2-6 PLANET ICS-102 / ICS-102S15 Front Panel

- **ICS-105A**—RS-232 / RS-422 / RS-485 over 100Base-FX (LC Interface)

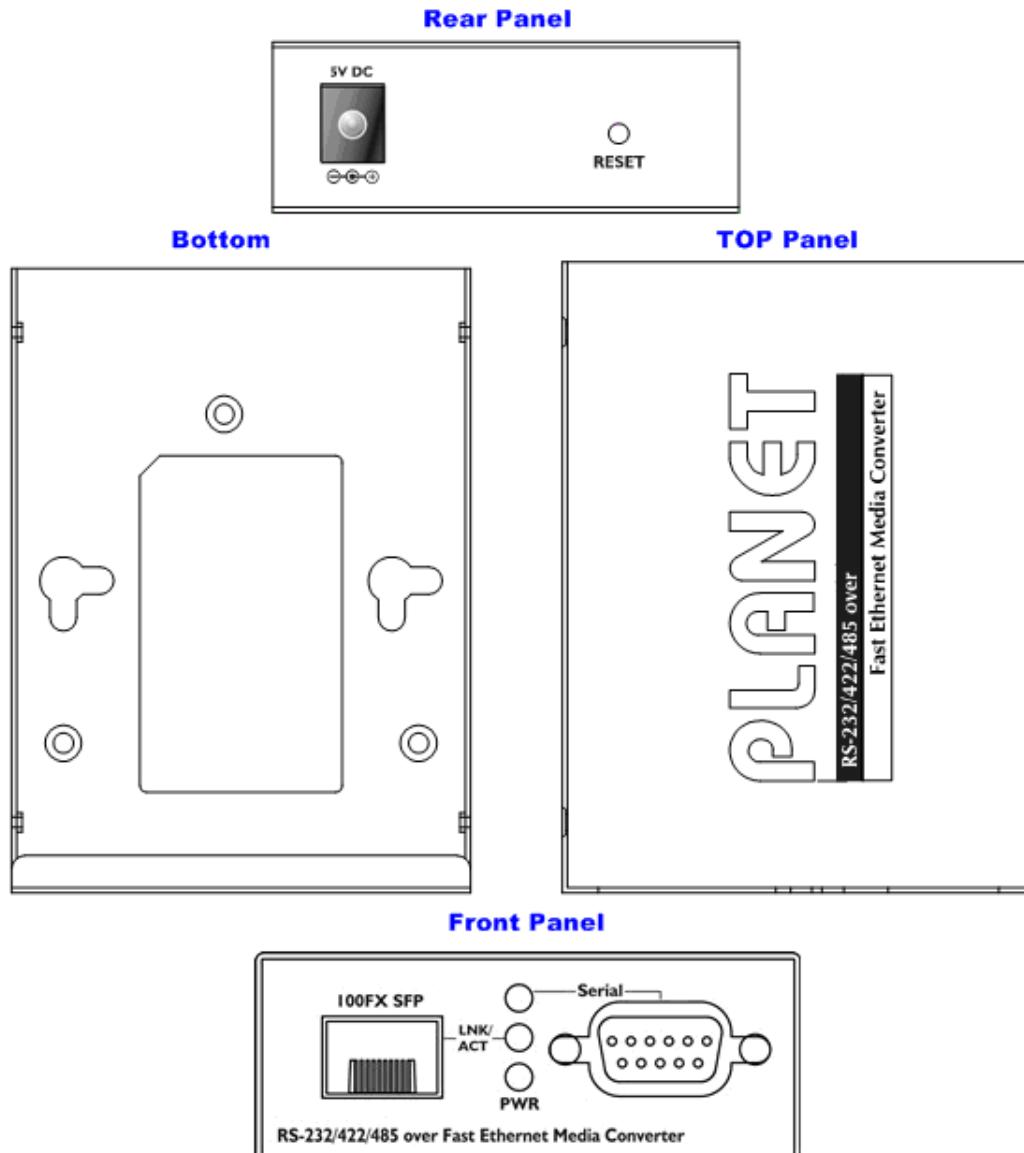

Figure 2-7 ICS-105A panel layout

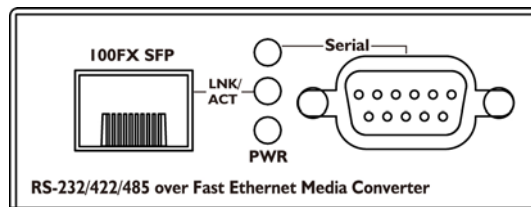

Figure 2-8 PLANET ICS-105A Front Panel

2.1.2 LED Indicators

LED	Color	Function	
PWR	Green	Lights	To indicate that the Switch is powered on.
TP or Fiber	Green	Lights	To indicate that the Fast Ethernet Port is successfully connecting to the network at 10Mbps or 100Mbps
		Blinks	To indicate the Fast Ethernet Port is receiving or sending data
Serial	Green	Lights	To indicate that the RS-232 Port is connected successfully
		Lights and off	To indicate the RS-422 Port is receiving or sending data
		Lights and off faster	To indicate the RS-485 Port is receiving or sending data

2.1.3 DB9 Pin Define

■ DB9 Pin Define for RS-232 / RS-422 / RS-485

	DB9-PIN	RS-232	RS-422/485 4-wire	RS-485 2-wire	
	1	DCD			
	2	RXD			
	3	TXD			
	4	DTR		RX-	Data B(-)
	5	GND			
	6	DSR		TX-	
	7	RTS		RX+	Data A(+)
	8	CTS		TX+	
	9	RI			

2.1.4 ICS-10X Rear Panel

The rear panel of the converter indicates one DC jack, which accepts input power with 5V DC 2A.

■ ICS-10x series



Figure 2-9 Rear Panel of ICS-10x

Power Notice:

1. The device is a power-required device, it means, it will not work till it is powered. If your networks should active all the time, please consider using UPS (Uninterrupted Power Supply) for your device. It will prevent you from network data loss or network downtime.
2. In some area, installing a surge suppression device may also help to protect your Media Converter from being damaged by unregulated surge or current to the converter or the power adapter.



To press and release the RESET button. The ICS-10x will back to the factory default mode. Be sure that you backup the current configuration of ICS-10x; else the entire configuration will be erased when pressing the "RESET" button.

- Press and release the RESET button shortly, the device will be rebooted.
- Press the RESET button more than 10 seconds, the device will back to the factory default mode; the entire configuration will be erased.

2.2 Install the Converter

This section describes how to install your ICS-10x Web Smart Media Converter and make connections to the converter. Please read the following topics and perform the procedures in the order being presented. The hardware installation of PLANET ICS-10x Web Smart Media Converter do not need software configuration. To install your ICS-10x on a desktop or shelf, simply complete the following steps.

2.2.1 Stand-alone Installation

To install an ICS-10x stand-alone, on a desktop or shelf, simply complete the following steps:

- Step 1:** Turn off the power of the device/station in a network to which the ICS-10x will be attached.
- Step 2:** Ensure that there is no activity in the network.
- Step 3:** Attach RJ-45 / SC / ST Fiber cable from the ICS-10x to the network.
- Step 4:** Attach RS-232/RS-485 cable from the ICS-10x to the want to connect devices.
- Step 5:** Connect the 5VDC power adapter to the ICS-10x and verify that the Power LED lights up.
- Step 6:** Turn on the power of the device/station; the PWR LED (Green) should light when all cables are attached.

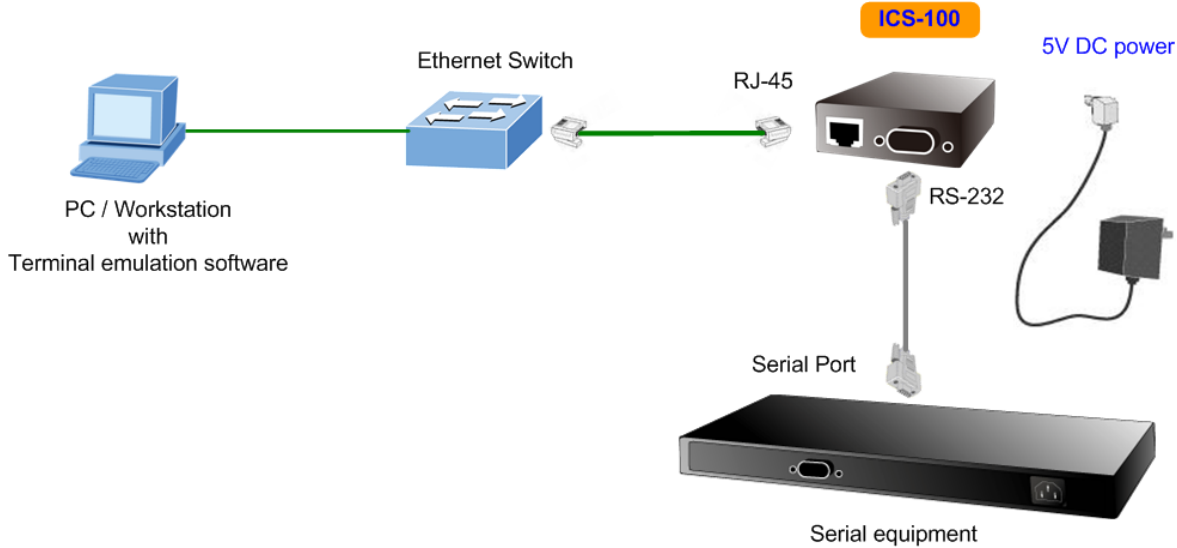

Figure 2-10 ICS-100 stand alone installation

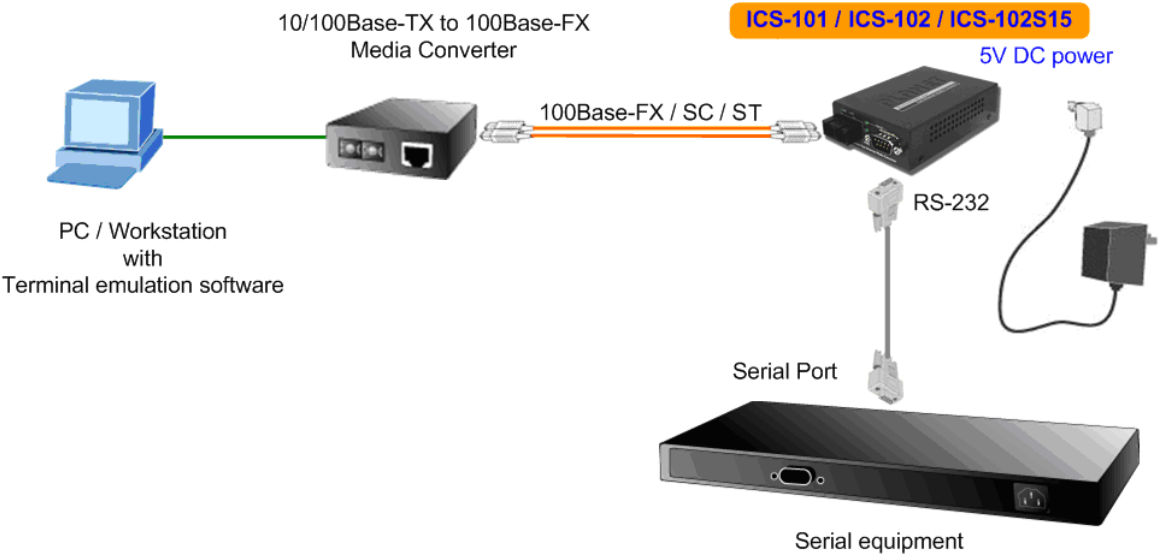

Figure 2-11 ICS-101 / ICS-102 / ICS-102S15 stand alone installation

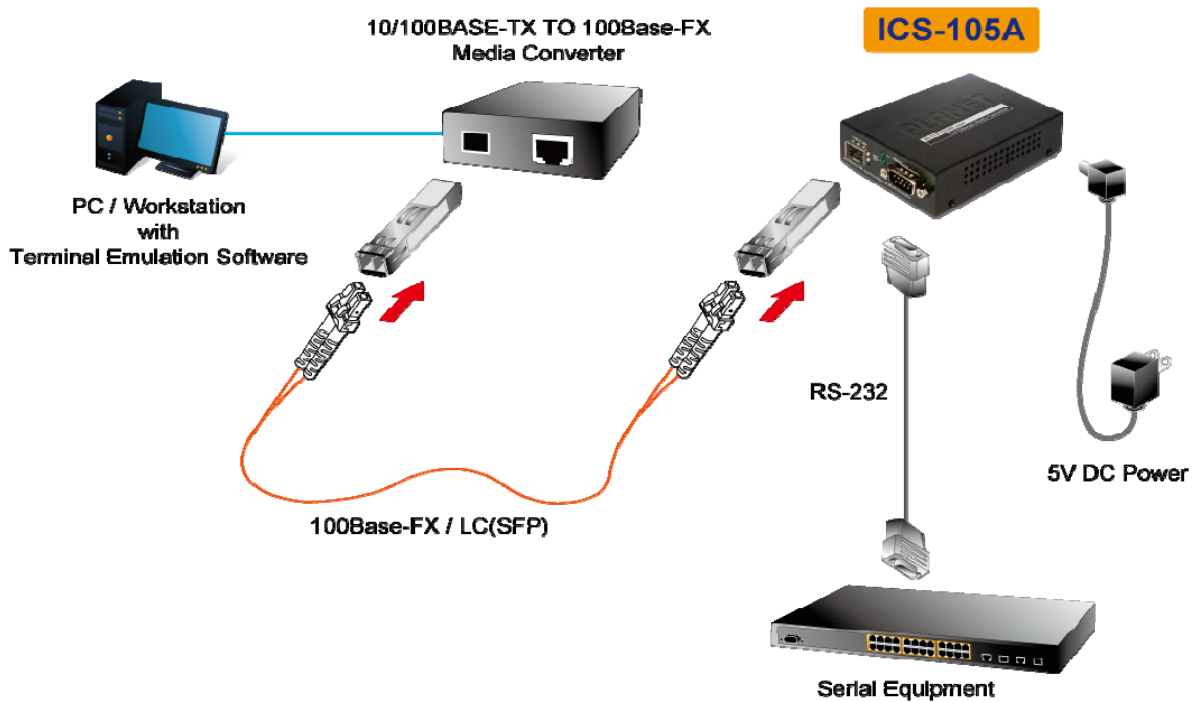

Figure 2-12 ICS-105A stand alone installation



Please refer to APPENDIX-A for detailed wiring information of the ICS-10x. To prevent from optic acceptor malfunction, check the both wires / transmitter before power on the converter.

2.2.2 Chassis Installation and Rack Mounting

To install the Media Converter in a **10-inch** or **19-inch** with standard rack, follow the instructions described below.

Step 1: Place your ICS-10x on a hard flat surface, with the front panel positioned towards your front side.

Step 2: Carefully slide in the module until it is fully and firmly fitted into the slot of the chassis.

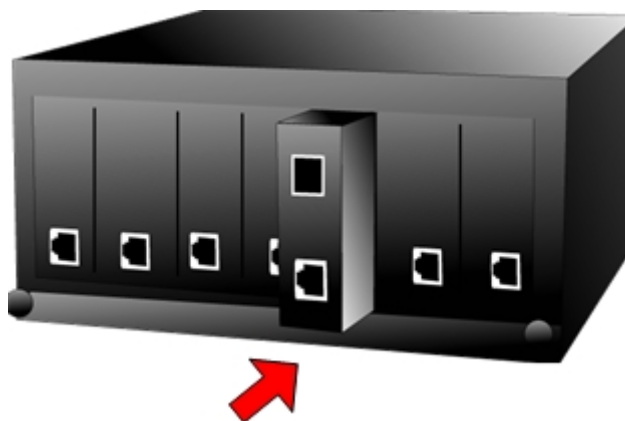

Figure 2-13 Insert a Media Converter into an available slot

Step 3: Attach a rack-mount bracket to each side of the Chassis with supplied screws attached to the package.

Step 4: After the brackets are attached to the chassis, use suitable screws to securely attach the brackets to the rack, as shown in Figure 2-14.

Step 5: Precede with the steps 4 and steps 5 of session **2.2.1 Stand-alone Installation** to connect the network cabling and supply power to your converter.



You must use the screws supplied with the mounting brackets. Damage caused to the parts by using incorrect screws would invalidate your warranty.

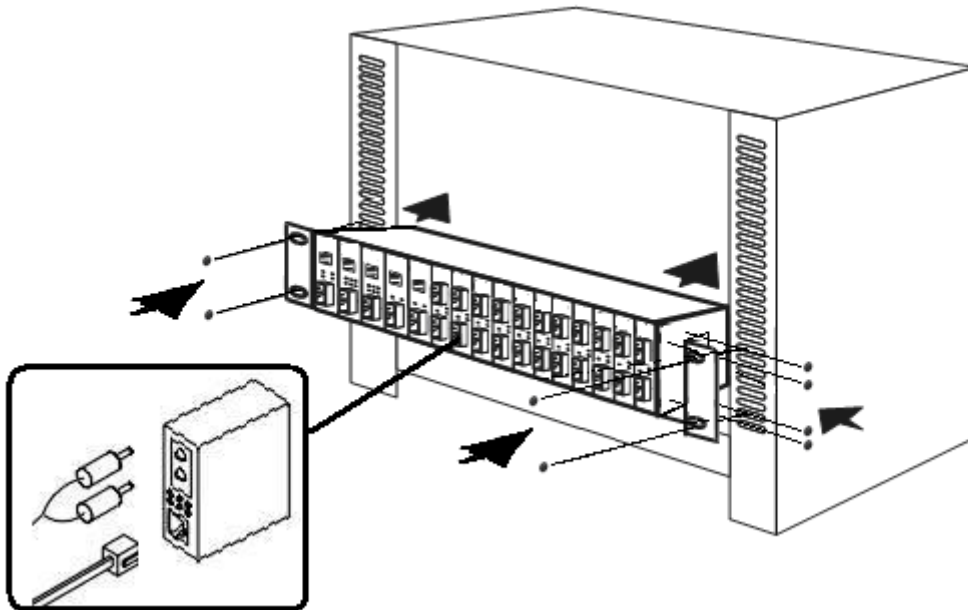

Figure 2-14 Mounting the Chassis in a Rack

3. MANAGEMENT

This chapter describes how to manage the ICS-10x. Topics include:

- Overview
- Management methods
- Assigning an IP address to the ICS-10x
- Logging on to the ICS-10x

3.1 Overview

This chapter gives an overview of converter management. The ICS-10x provides a simply **WEB browser interface**. Using this interface, you can perform various converter configuration and management activities, including:

- **System**
- **Network Configuration**
- **Operation Mode**
- **Serial Port Configuration**
- **SMTP**

Please refer to the following Chapter 4 for more details.

3.2 Requirements

- Network cables.
 - For ICS-100: Use standard network (UTP) cables with RJ-45 connectors.
 - For ICS-101: Use Multi-mode fiber patch cord with ST connectors.
 - For ICS-102 / ICS-102S15: Use Multi-mode or Single-mode fiber patch cord with SC connectors.
 - For ICS-105A: Use Multi-mode or Single-mode fiber patch cord with LC connectors.
- Subscriber PC installed with Ethernet NIC (Network Card)
- Workstations of subscribers running Windows 98/ME, NT4.0, 2000/2003/XP/Win7, MAC OS X or later, Linux, UNIX or other platform compatible with TCP/IP protocols.
- Above PC installed with WEB Browser, such as Microsoft Internet Explore or Mozilla Firefox



It is recommended to use **Internet Explore 6.0** or above to access Serial Media Converter.

3.3 Management Methods

The way to manage the ICS-10x:

- Web Management via a network or dial-up connection

3.3.1 Web Management

The PLANET Web-Smart Media Converter provides a built-in browser interface. You can manage the ICS-10x remotely by having a remote host with web browser, such as Microsoft Internet Explorer, Netscape Navigator or Mozilla Firefox.

Using this management method:

The ICS-10x must have an Internet Protocol (IP) address accessible for the remote host.

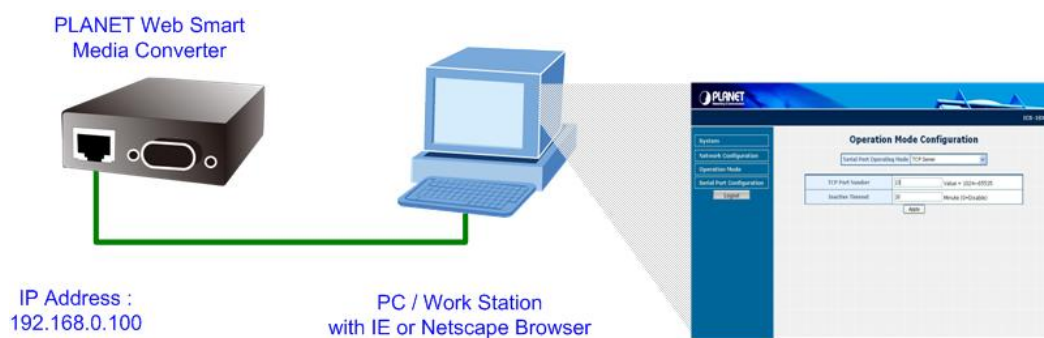

Figure 3-1 Web Management over Ethernet

3.3.2 Login the Media converter

Before you start configure the ICS-10x, please note the ICS-10x is configured through an Ethernet connection, make sure the manager PC must be set on same the **IP subnet address**.

For example, the default IP address of the ICS-10x is **192.168.0.100**, then the manager PC should be set at 192.168.0.x (where x is a number between 1 and 254 except 100), and the default subnet mask is 255.255.255.0.

1. Use Internet Explorer 6.0 or above Web browser. Enter IP address **http://192.168.0.100** (the factory-default IP address) to access the Web interface.
2. When the following login screen appears, please enter the default username and password (default user name and password is **"admin"**). Press Login to enter the main screen of ICS-10x. The login screen in Figure 3-2 appears.

Default IP Address: **192.168.0.100**

Default Account: **admin**

Default Password: **admin**

PLANET
Networking & Communication

ICS-10X

PLANET

RS-232/422/485 over Fast Ethernet Media Converter

Username:

Password:

Login

Copyright © 2008 All rights reserved.

Figure 3-2 Login screen



1. For security reason, please change and memorize the new password after this first setup.
2. Only accept command in lowercase letter under web interface.

4. WEB CONFIGURATION

The ICS-10X Web Smart Media Converter provide Web interface for Converter smart function configuration and make the Converter operate more effectively - They can be configured through the Web Browser. A network administrator can manage and monitor the ICS-10x from the local LAN. This section indicates how to configure the Media Converter to enable its smart function.

4.1 Main Menu

After a successful login, the main screen appears, the main screen displays the converter Welcome page. The screen in Figure 4-1 appears.

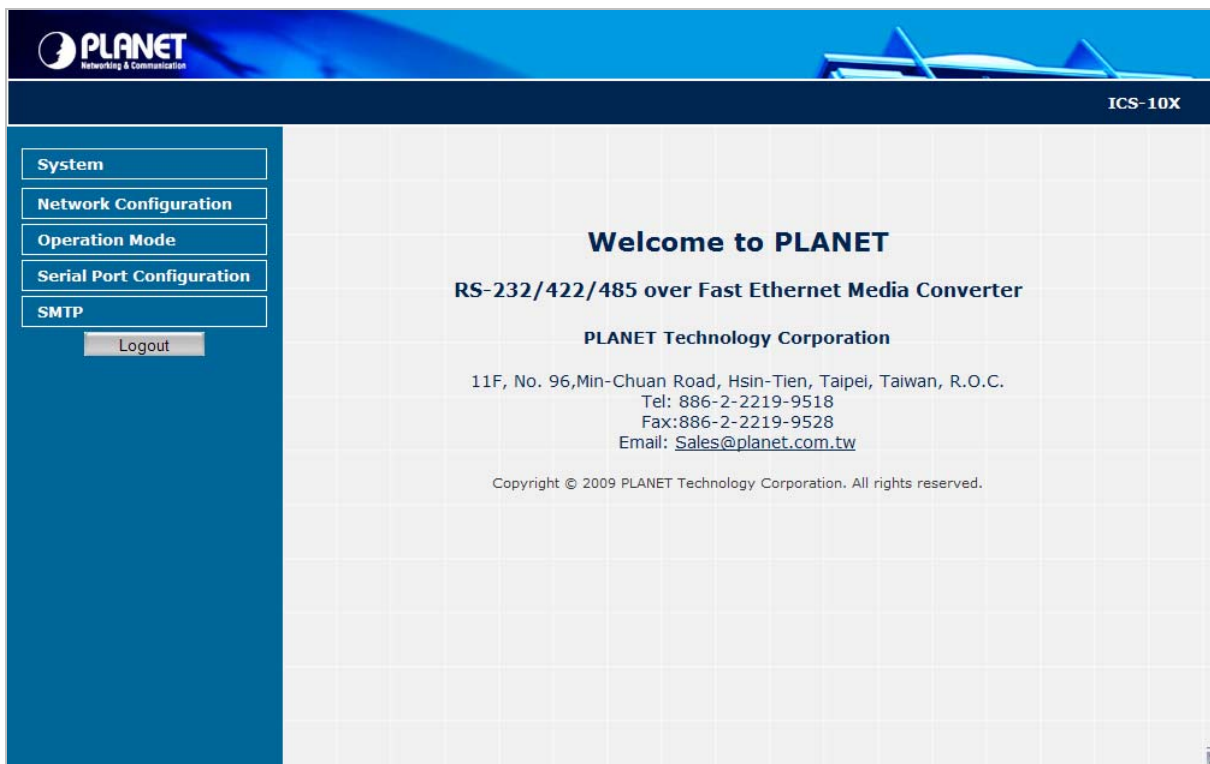

Figure 4-1 Web Main screen

As listed at the left of the main screen, the configurable smart functions are shown as below:

• System	Check the hardware, software version and System MAC address and IP address of the converter. And the password changed firmware upgrade / Factory default / system reboot.
• Network Configuration	Setup the IP address of the converter.
• Operation Mode	Setup the serial port mode: "TCP server", "TCP client", "UDP client", "Virtual COM", "Telnet Server", "Pair Connection – Remote (Master)" and "Pair Connection – Remote (Slave)".
• Serial Port Configuration	Setup the serial port value.
• SMTP	Setup the SMTP mail parameters for further operation of events.

4.2 System

4.2.1 System Information

The System Information page provides information for the current device. System Info page helps a network manager to identify the versions and IP Address etc. The screen in Figure 4-2 appears.

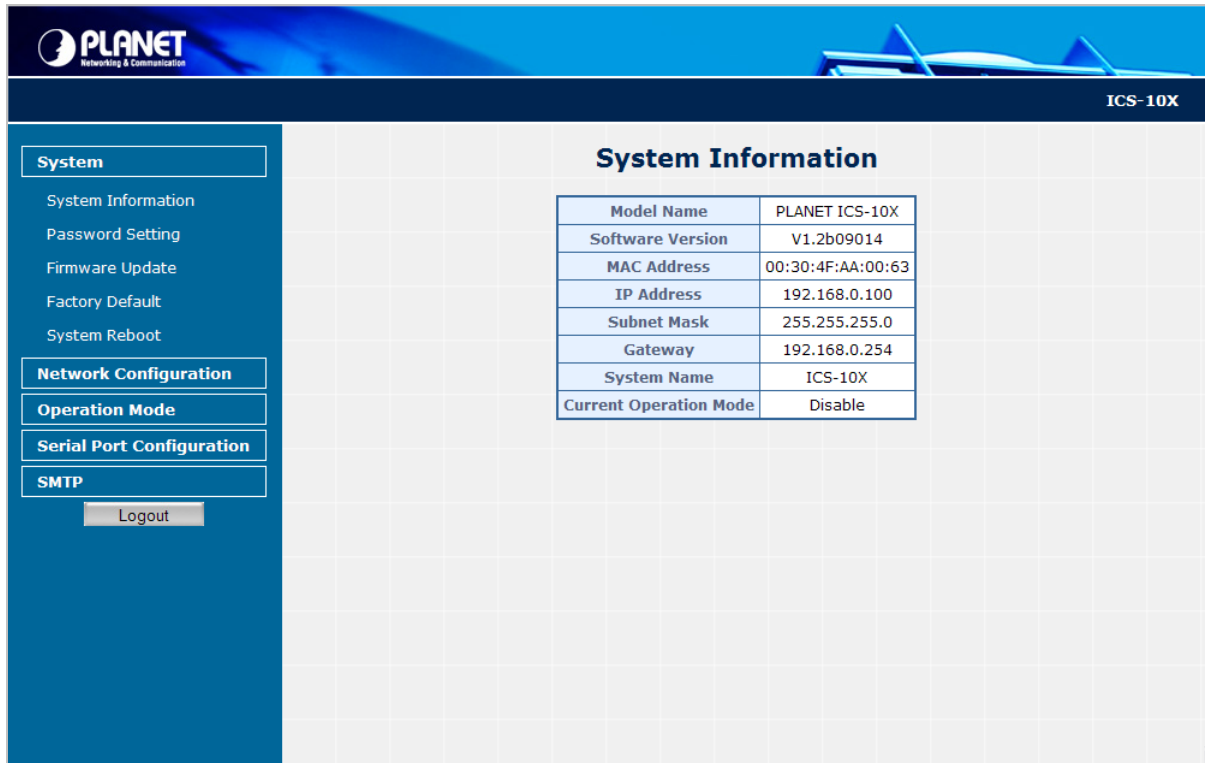

System Information	
Model Name	PLANET ICS-10X
Software Version	V1.2b09014
MAC Address	00:30:4F:AA:00:63
IP Address	192.168.0.100
Subnet Mask	255.255.255.0
Gateway	192.168.0.254
System Name	ICS-10X
Current Operation Mode	Disable

Figure 4-2 System Information screen

The page includes the following fields:

• Model Name	Specifies the device Model Name.
• Software Version	The current software version running on the device.
• MAC Address	Specifies the device MAC address.
• IP Address	The current IP Address of the device. The IP Address could be manual assigned. The factory default value is 192.168.0.100.
• Subnet Mask	The current IP Subnet Mask setting on the device. The factory default value is 255.255.255.0.
• Gateway	The default gateway for the IP interface. The factory default value is 192.168.0.254.
• System Name	The current IP Subnet Mask setting on the device.
• Current Operation Mode	Show the current serial port operation mode.

4.2.2 Password Setting

This function provides administrator to secure Web login. The screen in Figure 4-3 appears.

Figure 4-3 Password Setting screen

The page includes the following configurable data:

• Login Name	Displays the user name.
• New Password	Specifies the new password. The password is not displayed. As it entered an “•” corresponding to each character is displayed in the field. (The maximum length is 15 characters)
• Confirm Password	This confirms the new password. The password entered into this field must be exactly the same as the password entered in the Password field.



After change the default password, if you forget the password. Please press and release the “**Reset**” button in the front panel of ICS-10x, the current setting will be lost and the ICS-10x will restore to the default mode.

4.2.3 Firmware Upgrade

The **Firmware Upgrade** page contains fields for downloading system image files from the Local File browser to the device. The screen in Figure 4-4 appears.

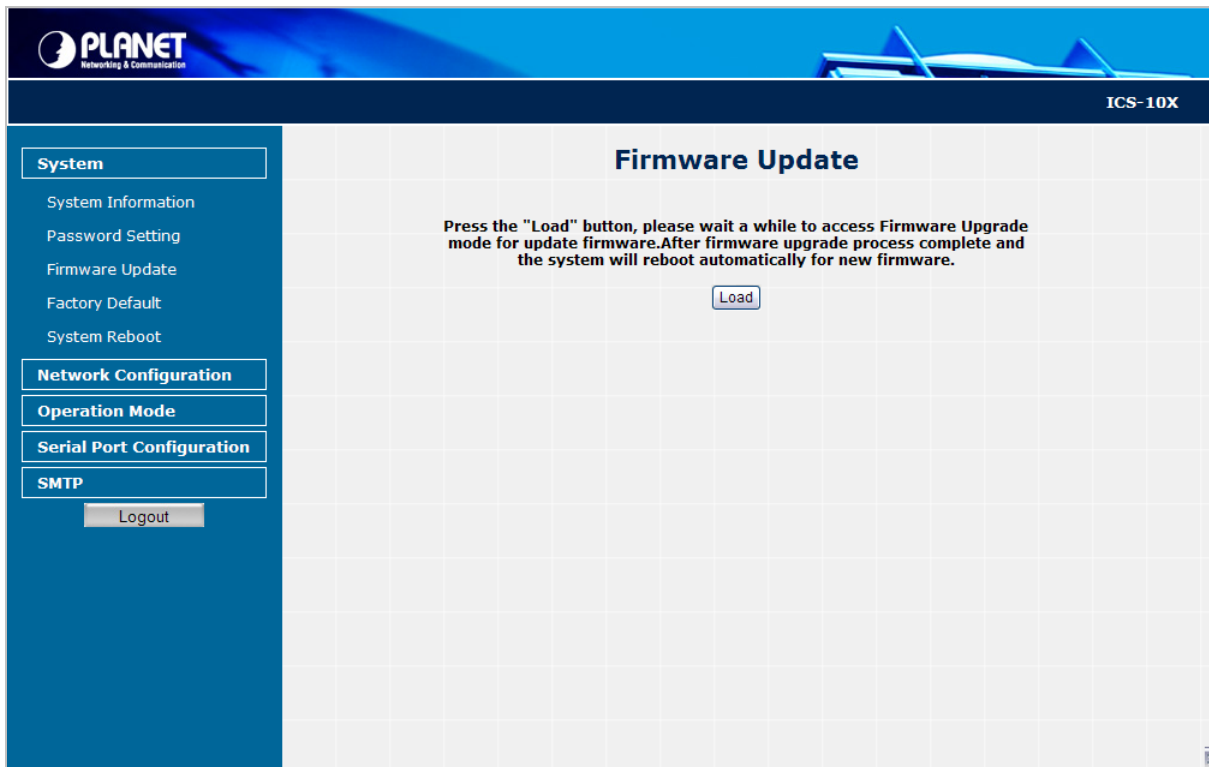

Figure 4-4 Firmware Upgrade screen

To open **Firmware Upgrade** screen perform the following:

1. Click **System** -> **Firmware Upgrade** then click **Load**.
2. The Firmware Upgrade screen is displayed as in Figure 4-5.

Erase Flash In Progress (77/128)
If this webpage doesn't refresh smoothly, please connect to <http://192.168.0.103> to continue.

Figure 4-5 Firmware Upgrade screen

3. Then the "Firmware Upgrade Mode" displayed as in Figure 4-6.

Firmware Update by Web browser

Select the image file:

Click "Update" to upload file:

Firmware Update by TFTP

There are two method to do the Firmware Update:

1. (By Web)Please browse to or type in the target image file in the upper input field, and then press update button to continue.
2. (By TFTP client)Use MS Windows' Command Prompt window to run tftp client program.
Syntax: `c:\tftp -i 192.168.0.103 put FILE_DIRECTORYFILENAME.bin`
3. If the update process somehow goes wrong(like power failure), please connect to <http://192.168.0.103> to restart.(If possible, reset device first.)
4. It takes about 45 seconds to complete the firmware update.

You'd better carefully read the document regarding the update procedure, preventing the unexpected problem form occurring.

Figure 4-6 Firmware Upgrade screen

- Click the "**Browse**" button of the main page, the system would pop up the file selection menu to choose firmware.

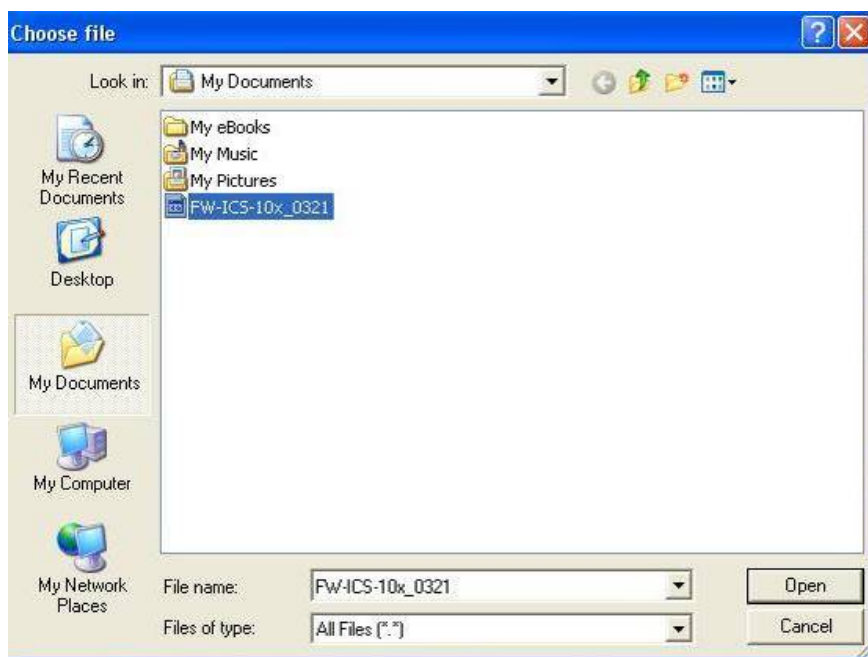

Figure 4-7 Windows file selection menu popup

4. Select on the firmware then click "**Upgrade**". The firmware upgrade may take 60 seconds.



Do not power off the converter until the update progress is complete.



Do not quit the Firmware Upgrade page without press the "Upgrade" button - after the image is loaded. Or the system won't apply the new firmware. Users have to repeat the firmware upgrade processes again.

4.2.4 Factory Default

The **Factory Default** can reset the ICS-10x back to the factory default mode. Be aware that the entire configuration will be reset, and the IP address of the ICS-10x will be set to "192.168.0.100". The screen in Figure 4-8 appears.



Figure 4-8 Factory Default progress screen

4.2.5 System Reboot

The **System Reboot** can restart the ICS-10x. The screen in Figure 4-9 appears.

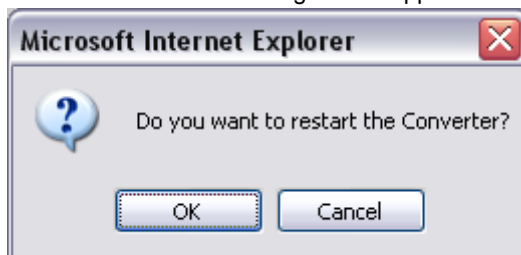

Figure 4-9 System Reboot progress screen

4.3 Network Configuration

This function allows setting the value for network configuration. The value is DHCP client, IP address, Subnet Mask, Gateway, DNS and system name. Press the **“Apply”** button to set the value. The screen in Figure 4-10 appears.

Figure 4-10 Network Configuration screen

The page includes the following configurable data:

• DHCP Client	<p>Disable or enable the DHCP function.</p> <p>When DHCP Client is set to “Enable”, the ICS-10x will send a DHCP request to the DHCP server in the network. Once the DHCP Server get the request, it will assign a dynamic IP address, subnet mask and gateway to the ICS-10x.</p> <p>The factory default setting is “Disable”</p>
• IP Address	<p>Assign the converter IP Address.</p> <p>The factory default value is 192.168.0.100</p>
• Subnet Mask	<p>Assign the converter Subnet Mask.</p> <p>The factory default value is 255.255.255.0</p>
• Gateway	<p>Assign the converter gateway.</p> <p>The factory default value is 192.168.0.254</p>
• DNS	<p>DNS is the way that Internet domain names are identified and translated into IP addresses. A domain name is an alphanumeric name, such as planet.com, that it is usually easier to remember. Assign the DNS server IP address.</p>
• System Name	<p>Allow set value for system name. (The maximum length is 15 characters).</p>



When DHCP Client is set to Enable, the IP Address, Subnet Mask, Gateway and DNS fields are not allow to be changed.

If the ICS-10x is set to DHCP Client enable, you can use **PLANET Smart Discovery** or **PLANET VCOM Utility** to search the ICS-10x which with DHCP assigned IP address.

4.4 Operation Mode

The ICS-10x make connected Serial equipment becomes IP-based. That also makes them be able to connect to a TCP/IP networking immediately. The ICS-10x allow traditional Computer/Client COM ports access to a serial equipment anywhere on the Ethernet LAN network.

This **Operation Mode** configure page allows setup Serial interface operation mode as below:

- **TCP Server**
- **TCP Client**
- **UDP Client**
- **Virtual COM**
- **Telnet Server**
- **Pair Connection – Local(Master)**
- **Pair Connection – Remote(Slave)**

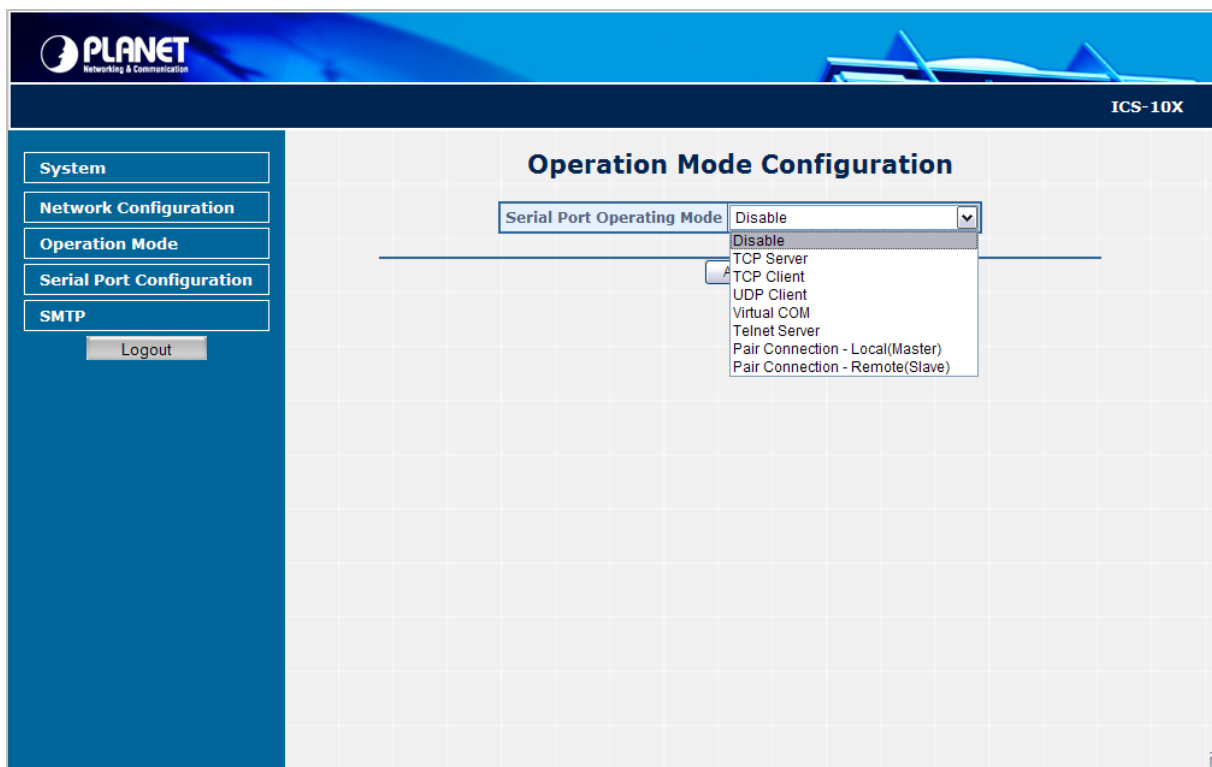

Figure 4-11 Operation Mode Configuration screen

Select the operation mode for the application and press the **“Apply”** button to take affect.

4.4.1 TCP Server Mode

When the ICS-10x be configured to **TCP Server** mode, it allows Serial device that connected to serial port of ICS-10x to establish TCP communication over Intranet or Internet network between:

- Remote Host (Computer) with Serial applications using TCP/IP network socket programs
- Other ICS-10x with **TCP Client** mode

It opens the TCP port of ICS-10x to wait for serial application to establish a TCP connection. After the connection is established, data can be transmitted in both directions.

The parameter defines the maintenance status for listen for the TCP connection.

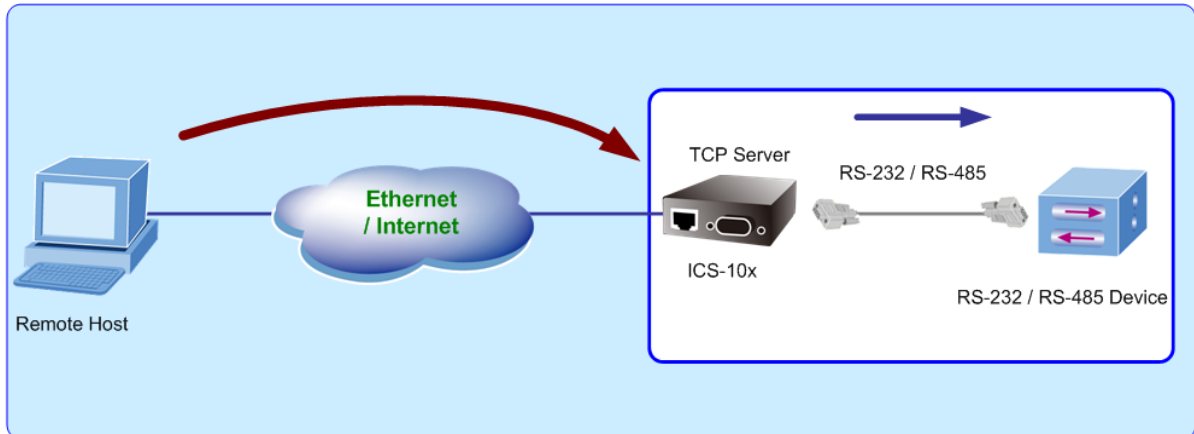

Figure 4-12 TCP Server mode

The screen in Figure 4-13 appears. When the changed operation mode, the user should be changed the Serial Port Configuration.

Operation Mode Configuration

Serial Port Operating Mode TCP Server

Support Protocol	<input type="checkbox"/> Reverse Telnet
TCP Port Number	<input style="width: 100px;" type="text" value="1024"/> Suggest Value = 1024~65535
Inactive Timeout	<input style="width: 100px;" type="text" value="20"/> Minute (0=Disable)

Figure 4-13 TCP Server Configuration screen

The page includes the following fields:

<ul style="list-style-type: none"> • Serial Port Operation Mode 	Choose different mode: <ul style="list-style-type: none"> ■ TCP Server ■ TCP Client ■ UDP Client ■ Virtual COM ■ Telnet Server
---	---

	<ul style="list-style-type: none"> ■ Pair Connection - Local(Master) ■ Pair Connection - Remote(Slave) <p>The default mode is "Disable".</p>
• TCP Port Number	The TCP port that ICS-10x uses to listen to connections and that other device must use to contact ICS-10x. To avoid conflicts with well known TCP ports, the default is set to "1024".
• Inactive Timeout	Use the parameter to set an inactive timeout. The unit drops the connection if there is no activity on the serial line before the set time expires. To disable the inactive timeout enter "0".

Example: Use Microsoft Windows Hyper Terminal, TCP/IP Winsock mode

HyperTerminal is a program that you can use to connect to other computers, Telnet sites, online services, and host computers, using your modem, a null modem cable, a Console cable or Ethernet connection.

The users want to use the TCP Server mode to connect to an Ethernet Switch via Hyper Terminal, Winsock mode

1. Setup Operation Mode and Serial Port of ICS-10x

2. Hyper Terminal set up a new connection with the TCP/IP Winsock

Setup Operation Mode and Serial Port of ICS-10x

- From the WEB interface, set the Serial operation mode of ICS-10x to "TCP Server" and set the TCP Port Number to "23".

The screenshot displays the 'Operation Mode Configuration' page in the ICS-10x web interface. The left sidebar contains navigation links: System, Network Configuration, Operation Mode, Serial Port Configuration, and SMTP, along with a Logout button. The main content area features a title 'Operation Mode Configuration' and a dropdown menu for 'Serial Port Operating Mode' currently set to 'TCP Server'. Below this, there are three rows of configuration options: 'Support Protocol' with a 'Reverse Telnet' checkbox, 'TCP Port Number' with a text input field containing '23' and a suggestion 'Suggest Value = 1024~65535', and 'Inactive Timeout' with a text input field containing '20' and a note 'Minute (0=Disable)'. An 'Apply' button is located at the bottom of these configuration fields.

Figure 4-14 Example: TCP Server Configuration screen

2. Set the Serial Port Configuration of ICS-10x as below:

Mode:	RS-232
Baudrate:	9600
Character Bits:	8
Parity Type :	none
Stop Bit :	1
Hardware Flow Control:	none

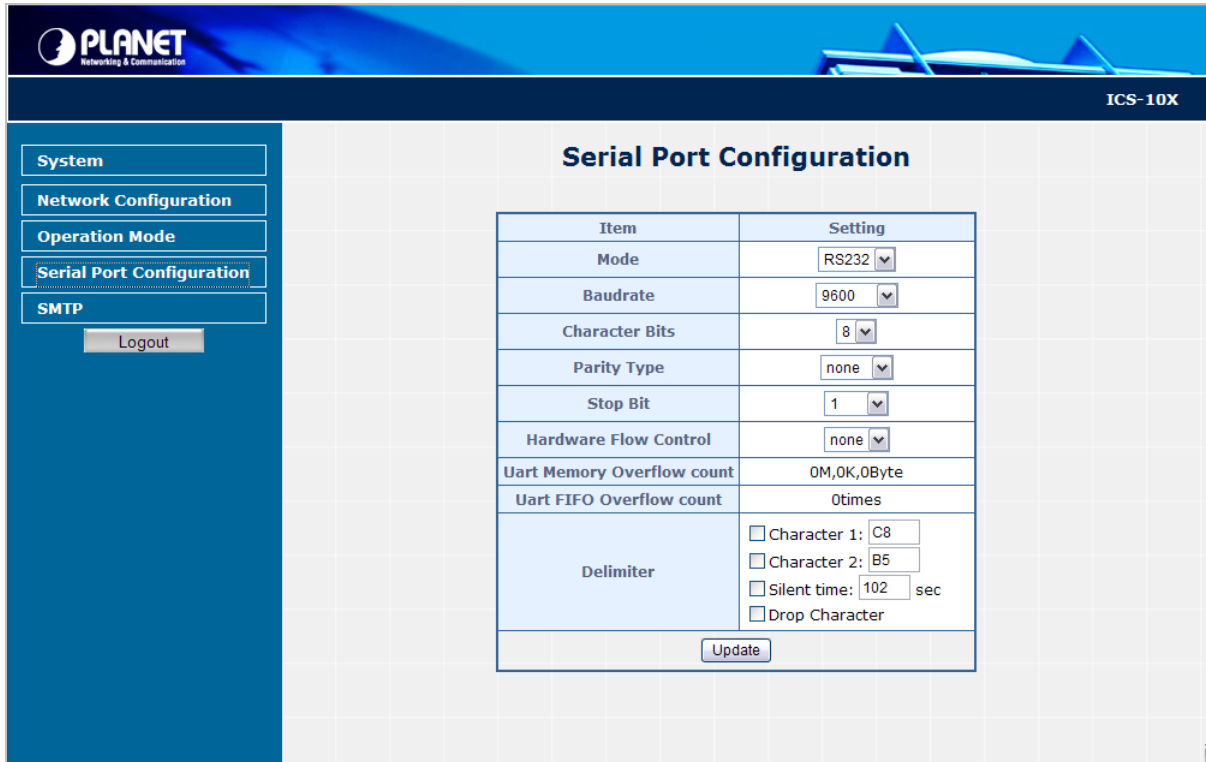

Figure 4-15 Example: Serial Port Configuration screen

Hyper Terminal setup a new connection with TCP/IP Winsock

3. Open HyperTerminal

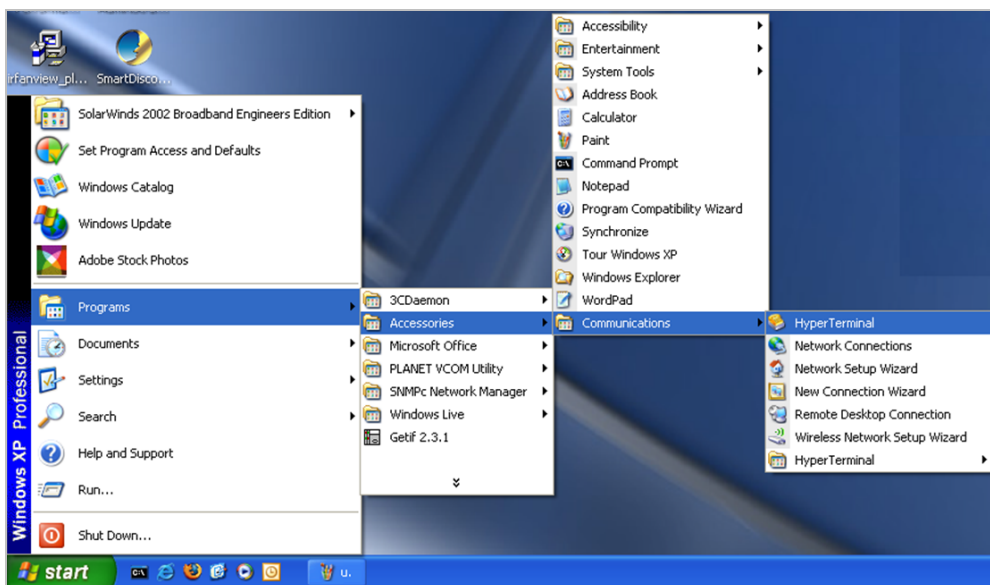

Figure 4-16 Example: Hyper Terminal screen

4. On the File menu, click **New Connection**.
5. In the Name box, give a name for the connection.
6. In the Icon box, click the appropriate icon, and then click OK.

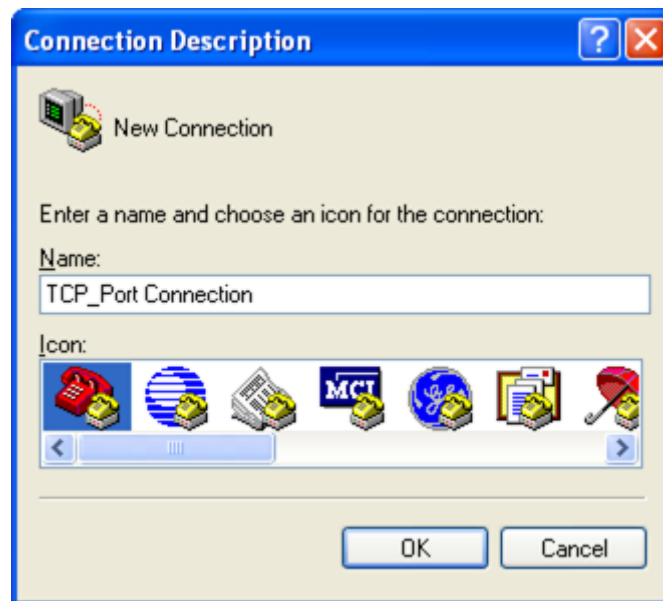

Figure 4-17 Example: Hyper Terminal – Create new connection

7. In the “Connect To” windows, choose which com port or modem you want to use in the Connect using drop-down box. In this case we are connecting via TCP/IP (Winsock).



Figure 4-18 Example: Hyper Terminal – Connect type

8. Enter the host address and port number, and then click OK.

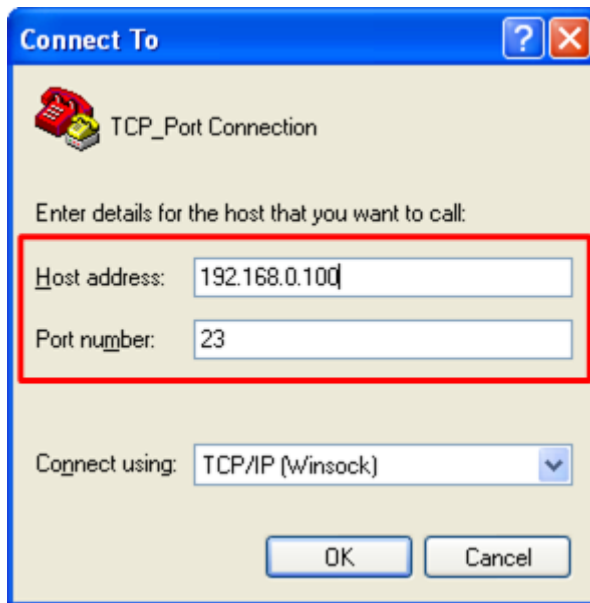

Figure 4-19 Example: Hyper Terminal configuration

Value	Description
Host address	The address or name of the connection you want to create. This can be in standard Internet dotted notation (for example, w.x.y.z) or can be the site's user-friendly name.
port	The number of the port that you want the connection to use. Port 23 is the default.

9. Then can use the serial console cable to connect with the switch.

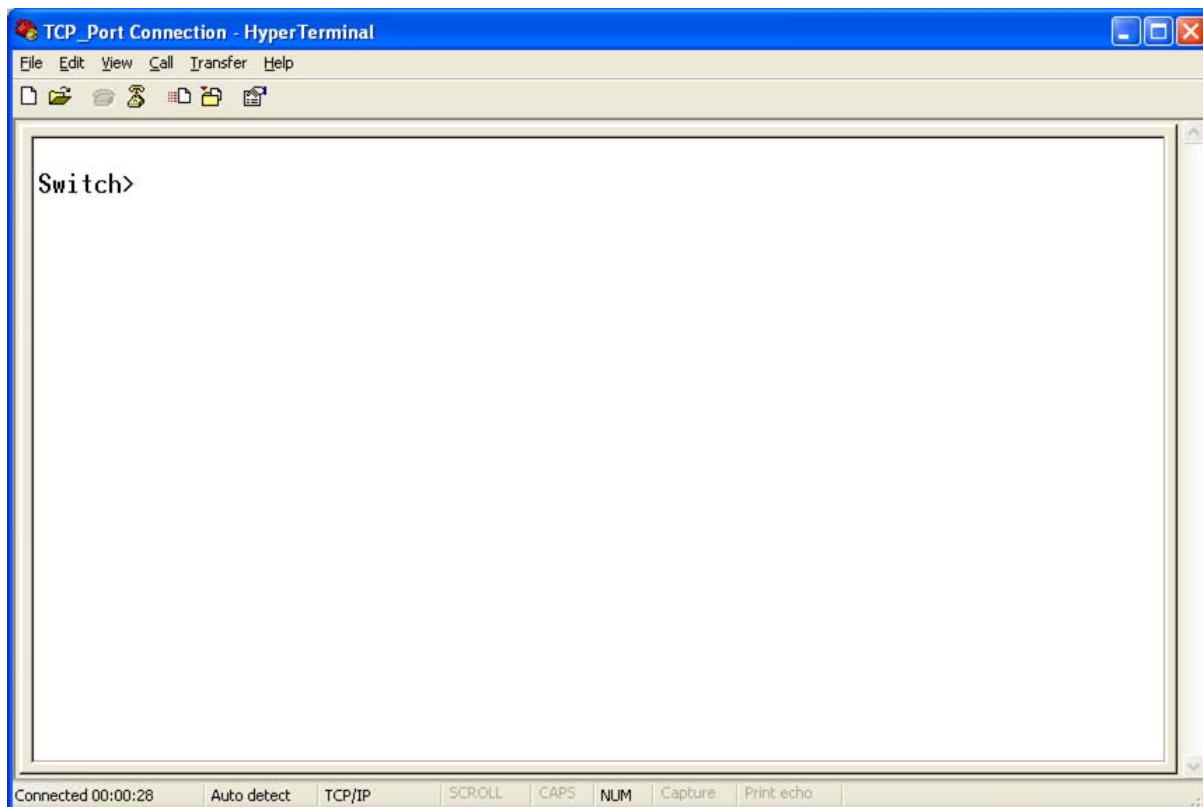

Figure 4-20 TCP/IP Winsock connection screen

4.4.2 TCP Client Mode

When the ICS-10x be configured to **TCP Client** mode, it allows Serial device that connected to serial port of ICS-10x to establish TCP communication **actively** over Intranet or Internet network between:

- Remote Host (Computer) with Serial applications using TCP/IP network socket programs
- Other ICS-10x with **TCP Server** mode

After the data has been transferred, the ICS-10x can disconnect automatically from the Remote Host depends on the TCP Inactive timeout settings. The parameter defines the maintenance status for listen for the TCP connection.

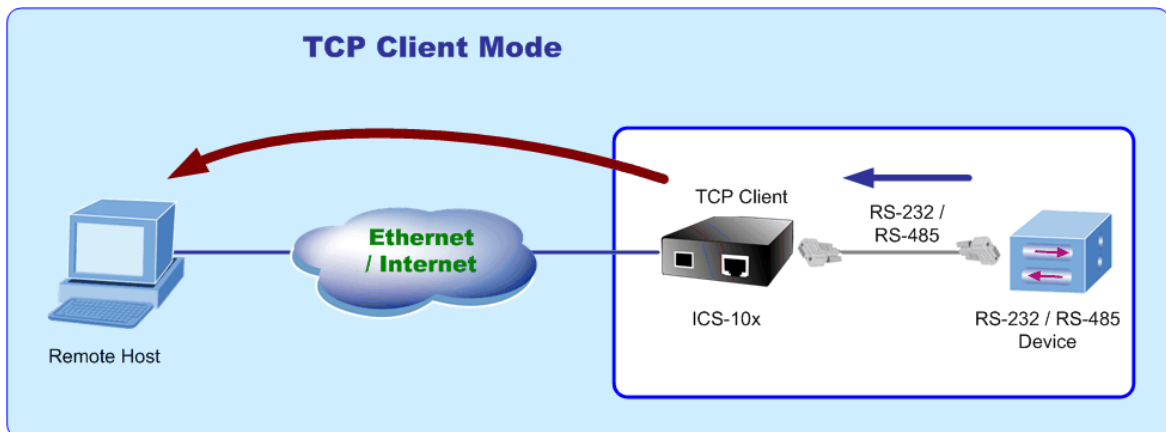

Figure 4-21 TCP Client mode

When changed to TCP Client operation mode, the screen in Figure 4-22 appears, the user can change the Serial Port Configuration.

Operation Mode Configuration

Serial Port Operating Mode TCP Client

Remote Host IP Address	0 . 0 . 0 . 0
Remote Host Port Number	1024 Suggest Value = 1024~65535
Inactive Timeout	20 Minute (0=Disable)

Figure 4-22 TCP Client Configuration screen

The page includes the following fields:

• Remote Host IP Address	Allow the ICS-10x to connect actively to the remote host whose IP address is set by this parameter.
• Remote Host Port Number	The remote host port number that ICS-10x uses to listen to connections and that other device must use to contact ICS-10x. To avoid conflicts with well known TCP ports, the default is set to "1024".
• Inactive Timeout	Use the parameter to set an inactive timeout. The unit drops the connection if there is no activity on the serial line before the set time expires. To disable the inactive timeout enter "0".

4.4.3 UDP Client Mode

When the ICS-10x be configured to **UDP Client** mode, it allows Serial device that connected to serial port of ICS-10x to quickly transmit data to **multiple Remote Hosts** over Intranet or Internet network by unicast or multicast. It also makes the Serial device to receive data from more than one Remote Hosts.

The parameter defines the maintenance status for listen for the UDP connection. In UDP Client mode, you need to define the remote IP Address and Local listen port number.

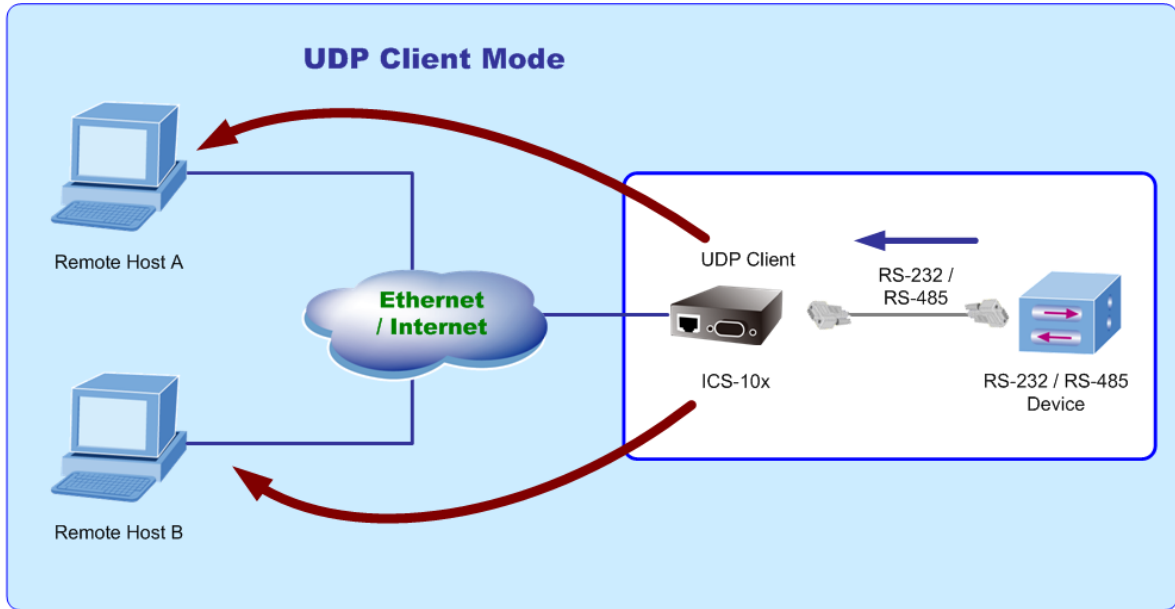

Figure 4-23 UDP Client mode

The screen in Figure 4-24 appears. When the changed operation mode, the user should be changed the Serial Port Configuration.

Operation Mode Configuration

Serial Port Operating Mode UDP Client

Local UDP Port	<input type="text" value="21"/>	(1~65535)
Remote Address	IP Address	Remote Port
	192 . 168 . 0 . 99	21
	0 . 0 . 0 . 0	0
	0 . 0 . 0 . 0	0
	0 . 0 . 0 . 0	0
	0 . 0 . 0 . 0	0
	0 . 0 . 0 . 0	0
	0 . 0 . 0 . 0	0
	0 . 0 . 0 . 0	0
	0 . 0 . 0 . 0	0

Figure 4-24 UDP Client Configuration screen

The page includes the following fields:

• Local UDP Port	Enter the local port number
• Remote Address	Enter the IP address of the remote device.
• Remote Port	Enter the remote port number of the remote device.

4.4.4 Virtual COM Mode

When the ICS-10x be configured to **Virtual COM** mode, it allows Serial device that connected to serial port of ICS-10x to establish TCP communication over Intranet or Internet network between Remote Host (Computer). The Virtual COM Port driver has to be installed at the Remote Host. Users can send data by Virtual COM port, and Virtual COM port will transfer data to Ethernet by windows socket. The Virtual COM driver maps IP Address / Port of ICS-10x to a local COM port on the Remote Host (Computer). Once the Virtual COM connection is established, the applications work as the serial device is direct connected to the Remote Host's real COM port. After the connection is established, data can be transmitted in both directions.

With connect to ICS-10x Serial over Fast Ethernet Converter, the serial devices are not limited to physical connection to the PC/Remote Host COM port and able to be extension over longer distance. The parameter defines the maintenance status for the Virtual COM.

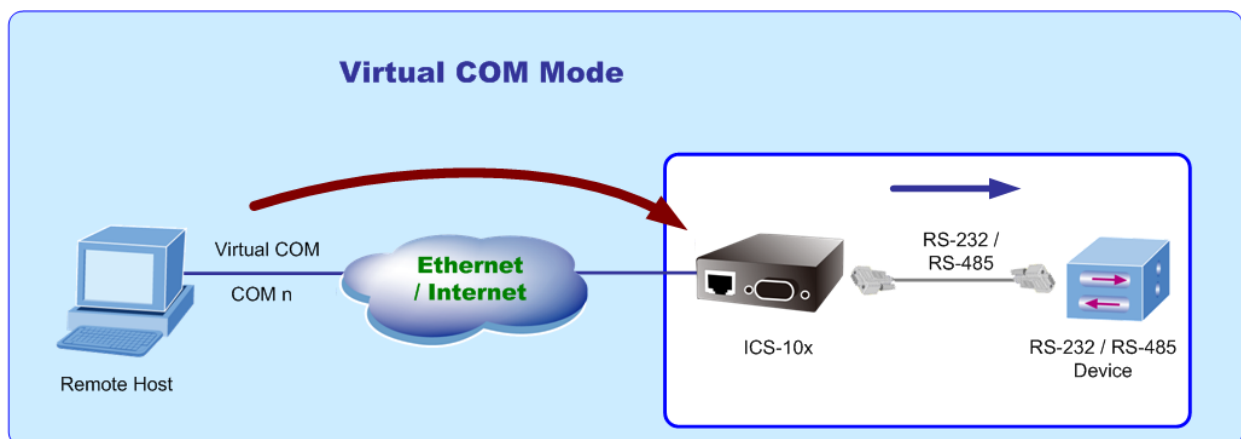

Figure 4-25 Virtual COM mode

When the changed operation mode, the user should be changed the Serial Port Configuration. The screen in Figure 4-26 appears.

Operation Mode Configuration

Serial Port Operating Mode: Virtual COM

Support Protocol	<input type="checkbox"/> Reverse Telnet
TCP Port Number	<input style="width: 100px;" type="text" value="1024"/> Suggest Value = 1024~65535
Inactive Timeout	<input style="width: 100px;" type="text" value="20"/> Minute (0=Disable)

Figure 4-26 Virtual COM Configuration screen

The page includes the following fields:

<ul style="list-style-type: none"> • TCP Port Number 	<p>The TCP port that ICS-10x uses to listen to connections and that other device must use to contact ICS-10x. To avoid conflicts with well known TCP ports, the default is set to "1024".</p>
<ul style="list-style-type: none"> • Inactive Timeout 	<p>Use the parameter to set an inactive timeout. The unit drops the connection if there is no activity on the serial line before the set time expires. To disable the inactive timeout enter "0".</p>

Example: Use PLANET VCOM Utility + Microsoft Windows Hyper terminal COM Port mode

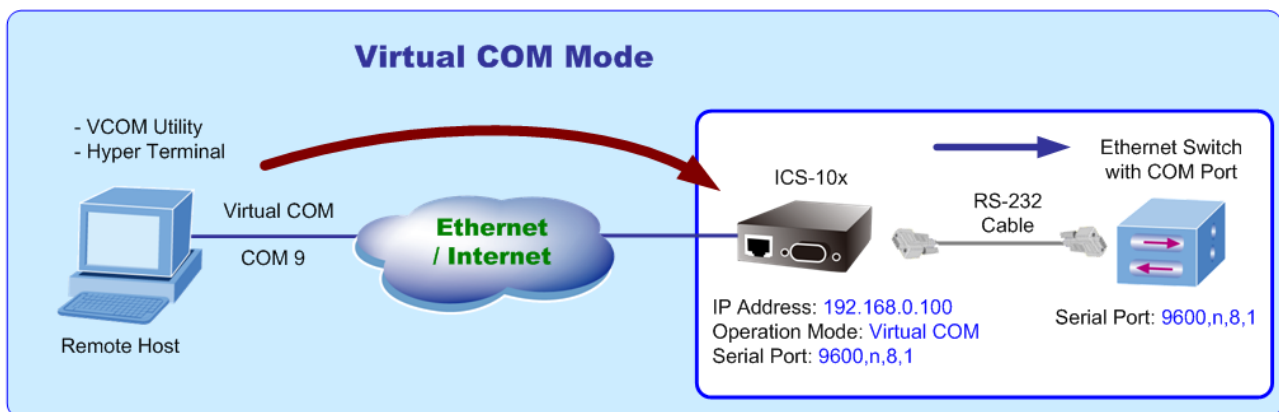

Figure 4-27 Virtual COM mode

The user want to use the virtual COM like to use the serial cable connect the switch.

1. **Setup Operation Mode and Serial Port of ICS-10x**
2. **Use PLANET VCOM Utility to create virtual COM Port**
3. **Hyper Terminal set up a new connection with the virtual COM port**

Setup Operation Mode and Serial Port of ICS-10x

1. From the WEB interface, set the Serial operation mode of ICS-10x to **“Virtual COM”** and set the TCP Port Number to **“1024”**.

Support Protocol	<input type="checkbox"/> Reverse Telnet
TCP Port Number	1024 Suggest Value = 1024~65535
Inactive Timeout	20 Minute (0=Disable)

Apply

Figure 4-28 Example: Virtual COM Configuration screen

2. Set the Serial Port Configuration of ICS-10x as below:

Mode:	RS-232
Baudrate:	9600
Character Bits:	8
Parity Type :	none
Stop Bit :	1
Hardware Flow Control:	none

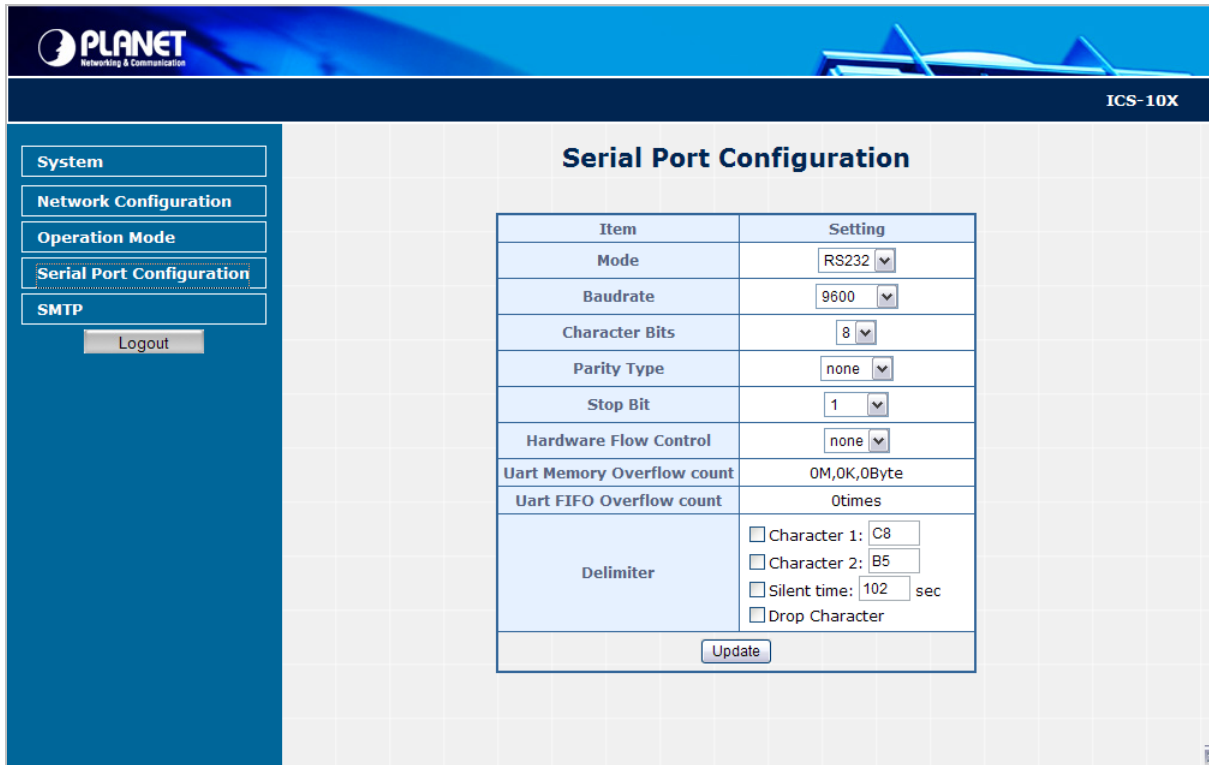

Figure 4-29 Example: Serial Port Configuration screen

VCOM Utility to create virtual COM port

- This mode will run with the software-“**PLANET VCOM Utility**”. Open the VCOM utility; click “Search” button to point out the ICS-10x that want to be configured.

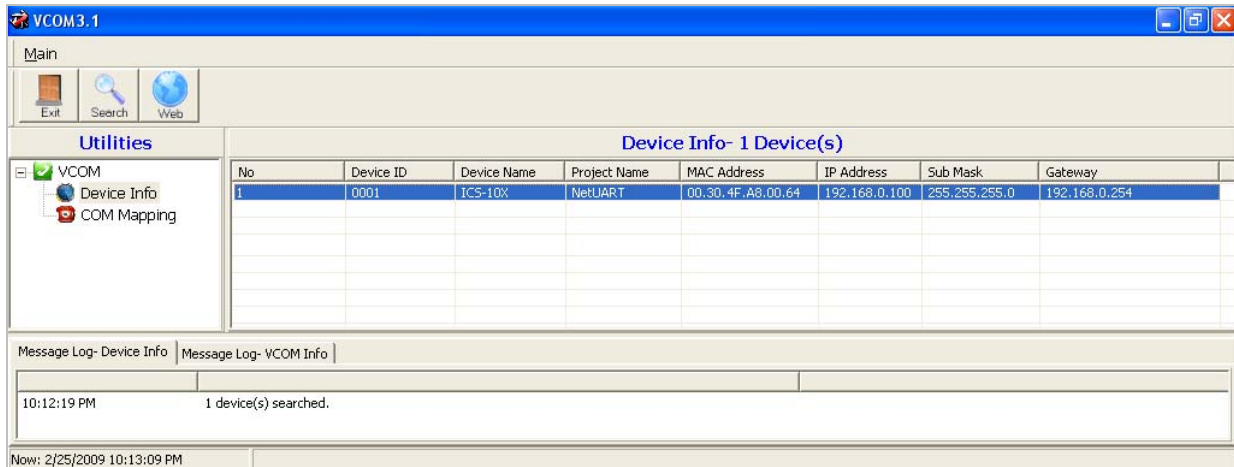
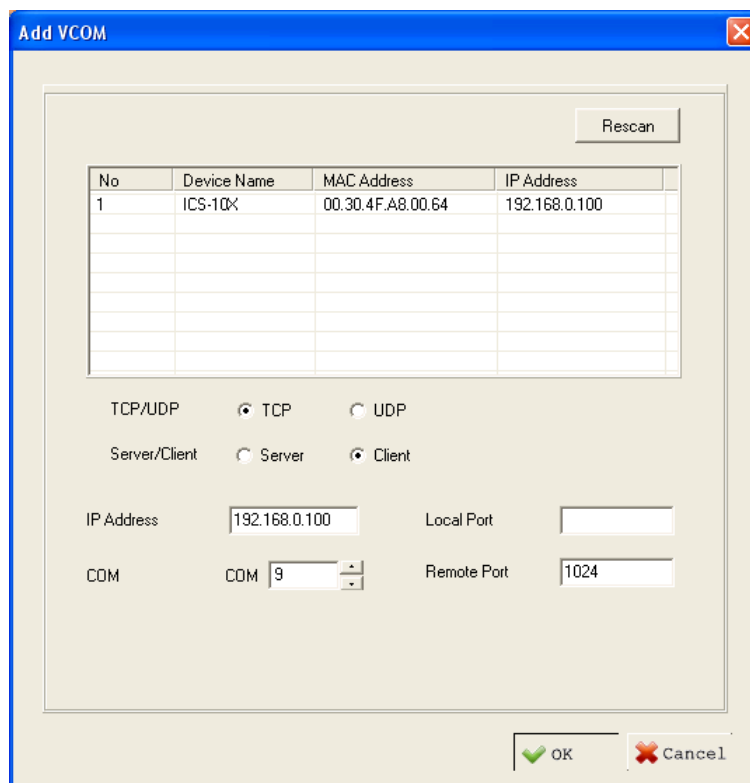

Figure 4-30 Example: Virtual COM Configuration screen

- Choose the COM Mapping and add **COM 9** like below:



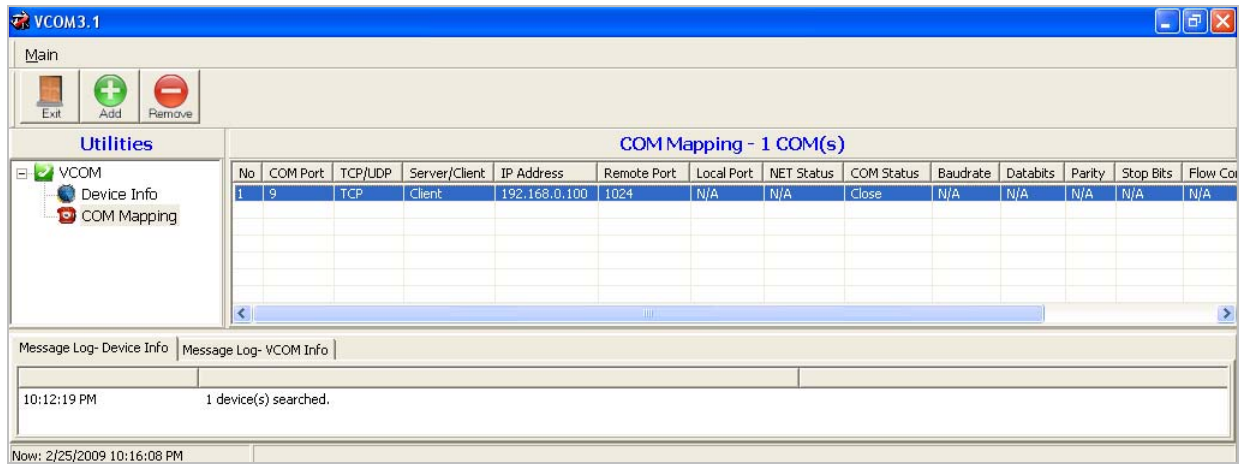

Figure 4-31 Example: Virtual COM Configuration screen

Hyper Terminal setup a new connection with virtual COM port

5. On the File menu, click New Connection.
6. In the Name box, give a name for the connection.
7. In the Icon box, click the appropriate icon, and then click OK.

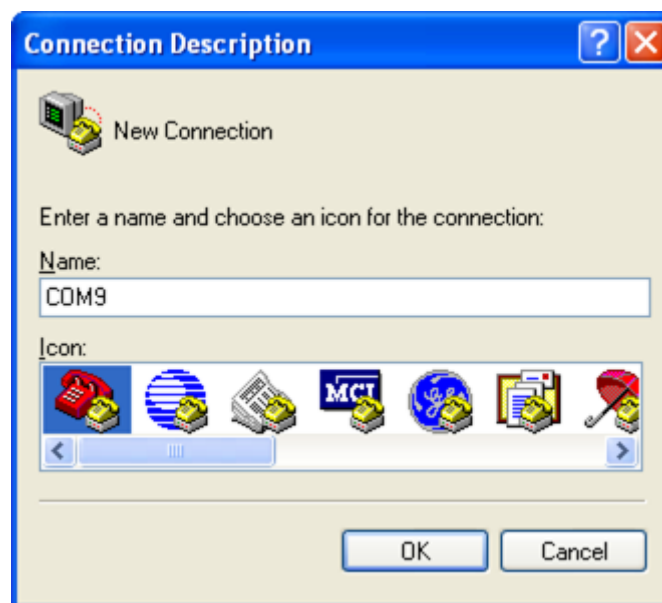

Figure 4-32 Example: HyperTerminal Configuration screen

- In the Connect to dialog box, choose which port you want to use in the Connect using drop-down box. In this case, choose COM9 (as created in Step-4)



Figure 4-33 Example: HyperTerminal Configuration screen

- Set the parameter like below, click "Apply" to take effect.

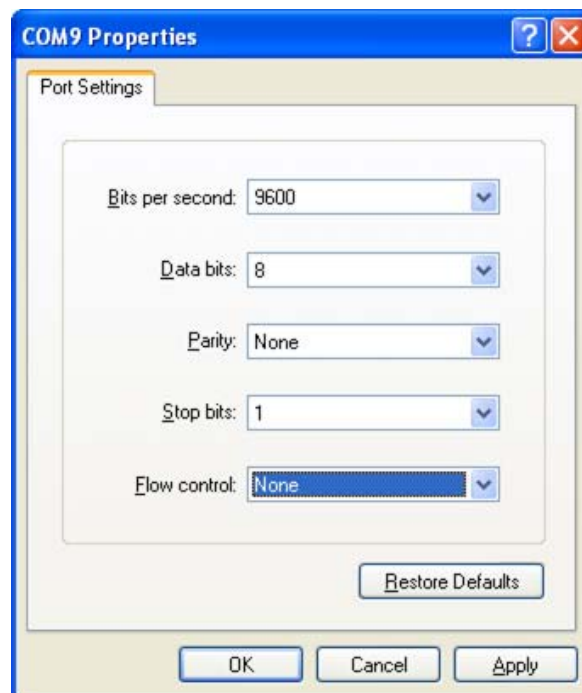

Figure 4-34 Example: HyperTerminal COM port properties screen

10. After the Virtual COM connection is established, open the VCOM utility again to check the COM9 information.

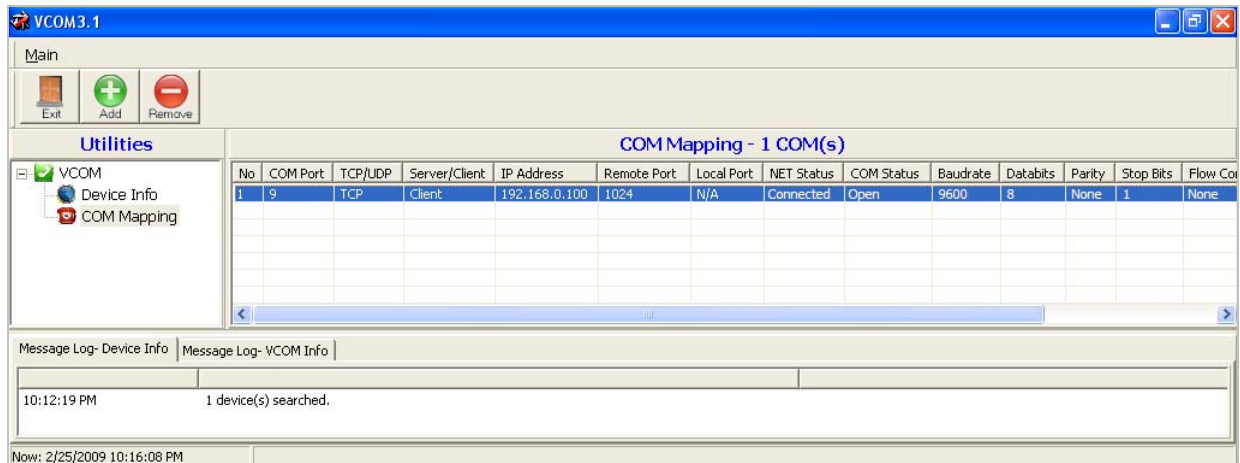

Figure 4-35 Example: VCOM Utility, COM9 information

11. Then can use the serial console cable to connect with the switch.

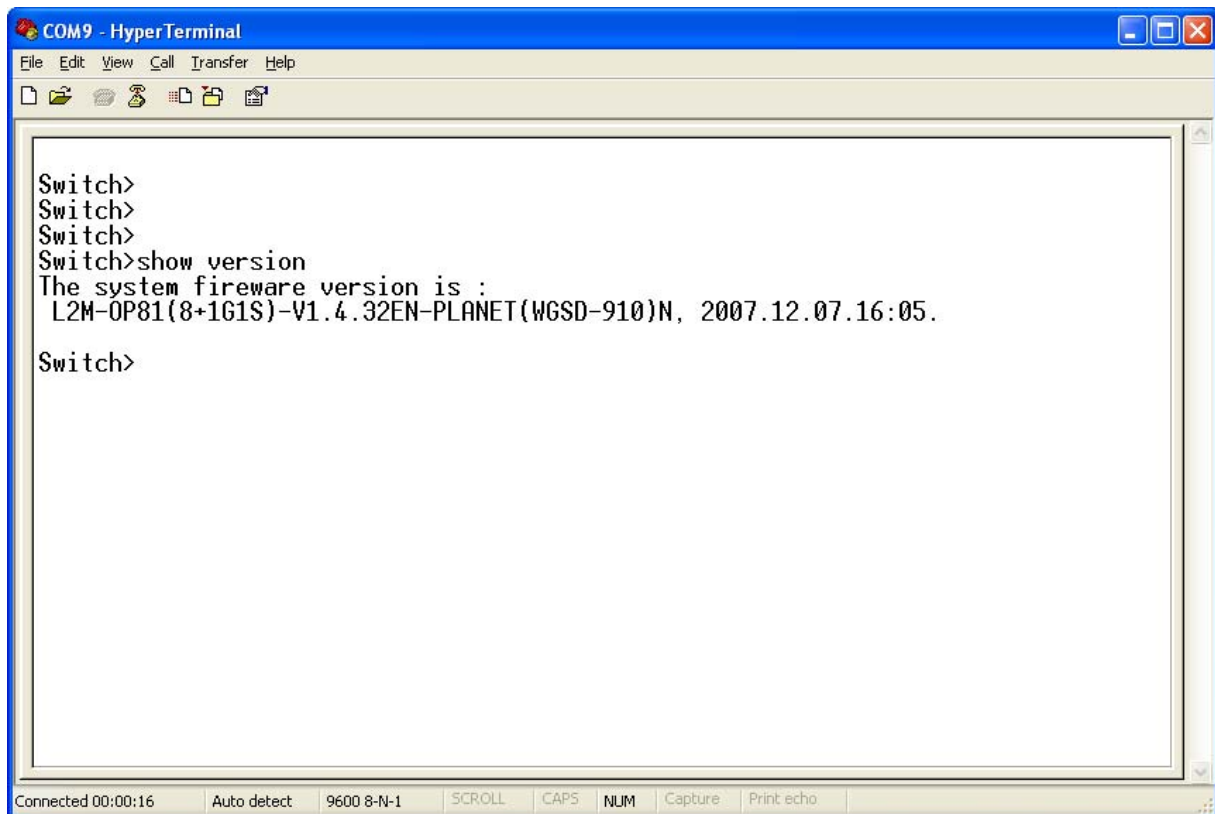

Figure 4-36 Example: Hyper Terminal COM port screen

4.4.5 Telnet Server Mode

TELNET (TELEcommunication NETwork) is a network protocol used on the Internet or local area network (LAN) connections. The Telnet protocol type is the correct setting for most servers and serial devices, such as Managed Ethernet switches or Gateways. In most of the case, the telnet use TCP port 23 as communication port.

The parameter defines the maintenance status for Telnet server.

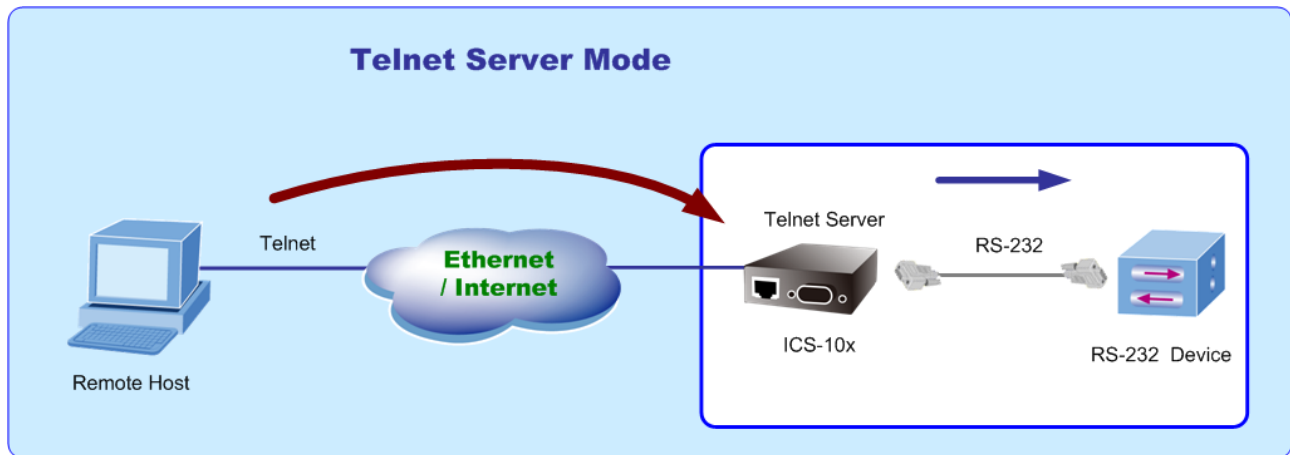

Figure 4-37 COM port screen

When changed operation mode, the user should be changed the Serial Port Configuration. The screen in Figure 4-38 appears.

Operation Mode Configuration

Serial Port Operating Mode Telnet Server

Support Protocol	<input type="checkbox"/> Reverse Telnet
Telnet Port Number	<input style="width: 100px;" type="text" value="1024"/> Suggest Value = 1024~65535
Inactive Timeout	<input style="width: 100px;" type="text" value="20"/> Minute (0=Disable)

Figure 4-38 Telnet Server Configuration screen

The page includes the following fields:

<ul style="list-style-type: none"> • TCP Port Number 	<p>The TCP port that ICS-10x uses to listen to connections and that other device must use to contact ICS-10x. To avoid conflicts with well known TCP ports, the default is set to "1024".</p>
<ul style="list-style-type: none"> • Inactive Timeout 	<p>Use the parameter to set an inactive timeout. The unit drops the connection if there is no activity on the serial line before the set time expires. To disable the inactive timeout enter "0".</p>



The ICS-10x's "telnet server mode"--if the user used the MS-DOS telnet command it will show double character. So the user can use other Telnet software like: "putty" or "NetTerm".

Example 1: Telnet Command in Windows Platform

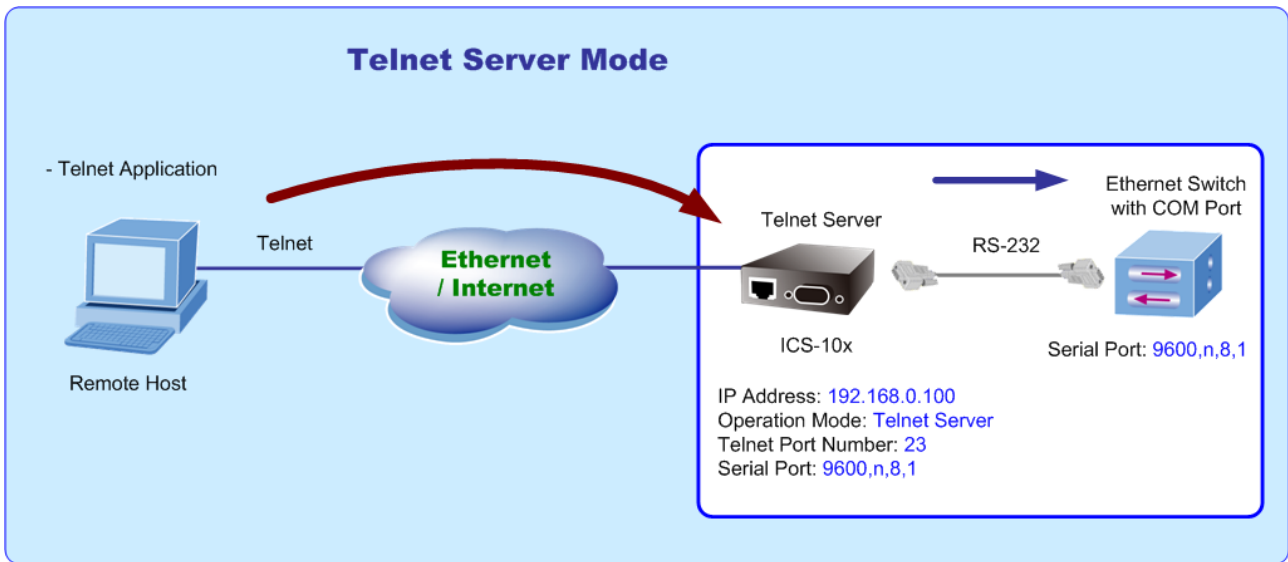

Figure 4-39 Example Telnet Server

Setup Operation Mode and Serial Port of ICS-10x

1. Set the ICS-10x mode to "Telnet server mode" from web interface.
2. Set the Serial Port Configuration of ICS-10x as below:

Mode:	RS-232
Baudrate:	9600
Character Bits:	8
Parity Type :	none
Stop Bit :	1
Hardware Flow Control:	none

Execute "Telnet" command from Windows Start Menu

3. Click the **Start Menu** and go to **Run**
4. Type "telnet" without the quotes and hit enter.

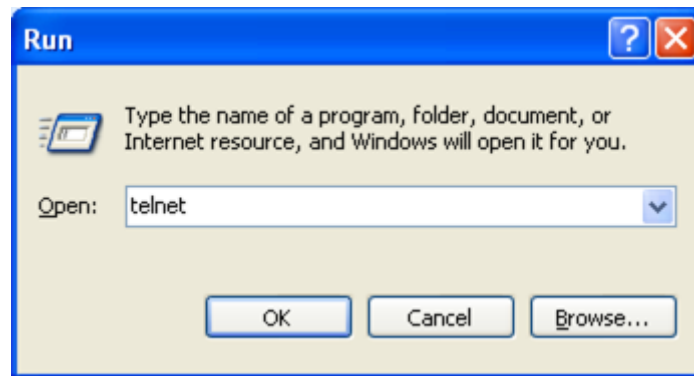

Figure 4-40 Example Windows Excuse - Telnet

5. While the Telnet window appears, type “open xxx,xxx,xxx,xxx”, xxx is the IP address of the ICS-10x Telnet Server. In this case we type “open 192.168.0.100” and press enter.

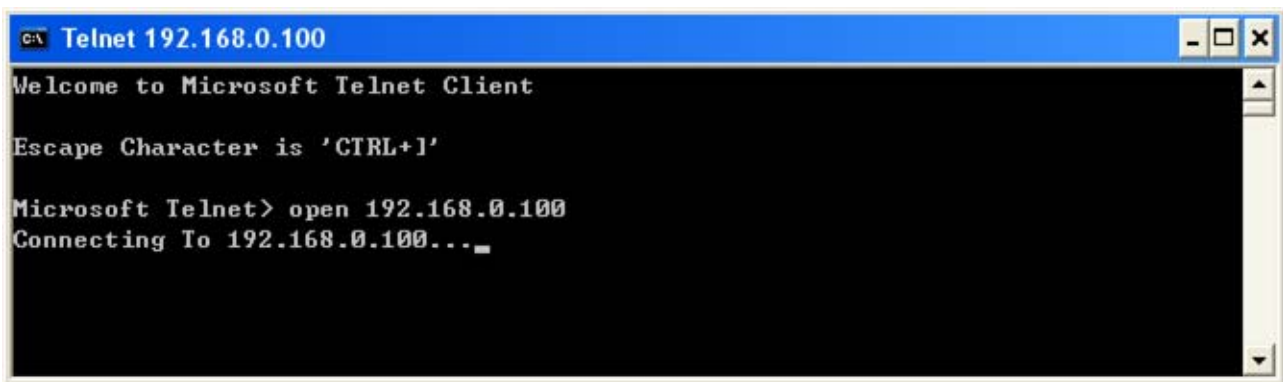

Figure 4-41 Example Windows Excuse - Telnet

6. Then can use the telnet connection to configure the switch just like console direct connect to the COM port of the switch.



Figure 4-42 Example Windows Excuse - Telnet

- To quit the Telnet session, press "CTRL+] " and then type "quit"

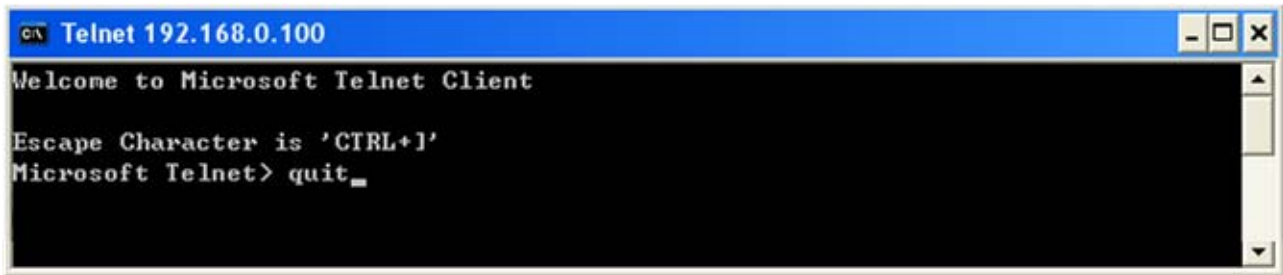

Figure 4-43 Example Windows Excuse - Telnet

Example 2: Putty software in Windows Platform

PuTTY is a free implementation of Telnet and SSH for Win32 and Unix platforms, along with an xterm terminal emulator. In this case we use Putty to telnet to the ICS-10x-Telnet Server mode for remote console login.

- Set the ICS-10x mode to "Telnet server mode" from web interface.
- Run the Telnet software like "Putty" and set the parameter like below:

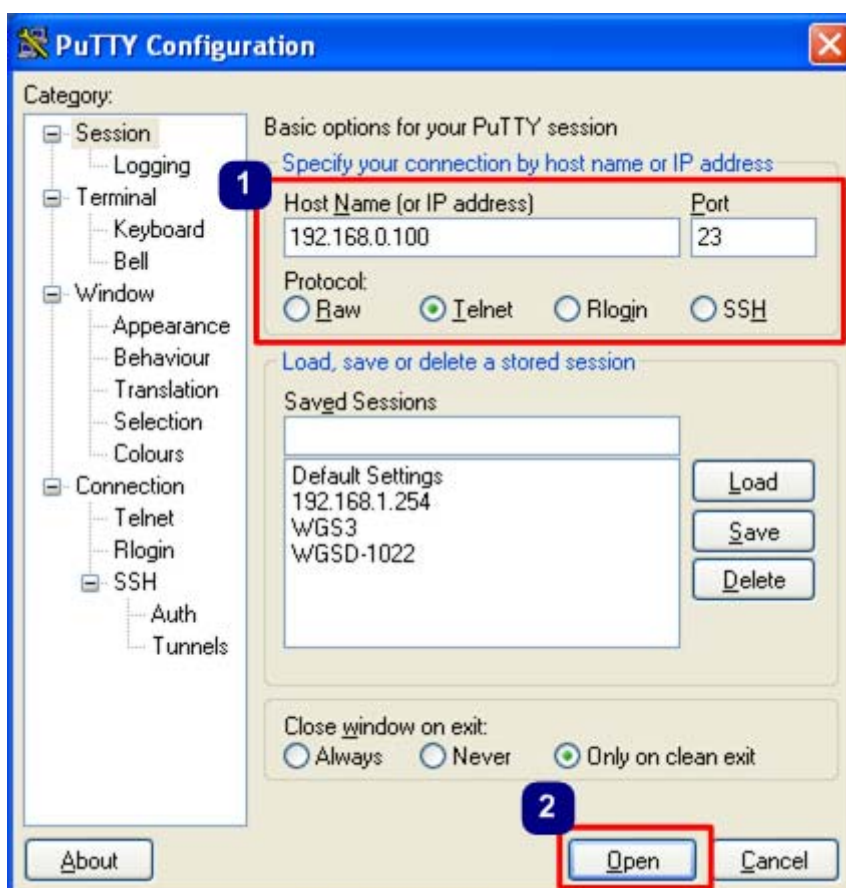
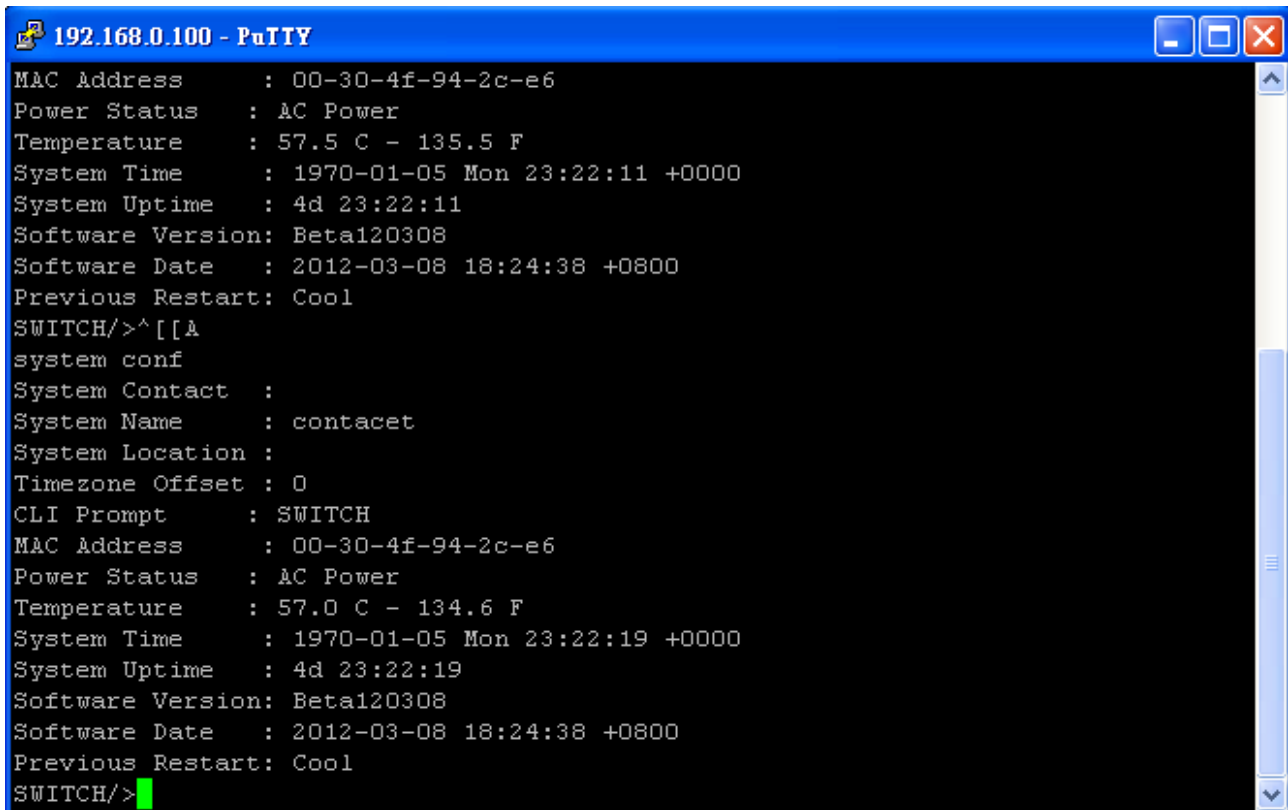

Figure 4-44 Putty Configuration screen

3. Then can telnet IP address like to telnet switch's IP.



```
192.168.0.100 - PuTTY
MAC Address      : 00-30-4f-94-2c-e6
Power Status     : AC Power
Temperature      : 57.5 C - 135.5 F
System Time      : 1970-01-05 Mon 23:22:11 +0000
System Uptime    : 4d 23:22:11
Software Version : Beta120308
Software Date    : 2012-03-08 18:24:38 +0800
Previous Restart : Cool
SWITCH/>>^[A
system conf
System Contact   :
System Name      : contacet
System Location  :
Timezone Offset  : 0
CLI Prompt       : SWITCH
MAC Address      : 00-30-4f-94-2c-e6
Power Status     : AC Power
Temperature      : 57.0 C - 134.6 F
System Time      : 1970-01-05 Mon 23:22:19 +0000
System Uptime    : 4d 23:22:19
Software Version : Beta120308
Software Date    : 2012-03-08 18:24:38 +0800
Previous Restart : Cool
SWITCH/>>
```

Figure 4-45 Putty telnet screen

4.4.6 Pair Connection– Local Mode

The parameter defines the maintenance status for listen for the pair connection. To make a long distance communication between two serial equipment, configure two ICS-10x with Pair Connection mode and setup one as a Master (Local side) and the other as a Slave (Remote side).

- **Pair Connection – Local (Master)** – the ICS-10x is locate close to the Host Computer or control device and connect to it via serial interface.
- **Pair Connection – Remote (Slave)** – the ICS-10x is locate close to the remote serial equipment and connect to it via serial interface.

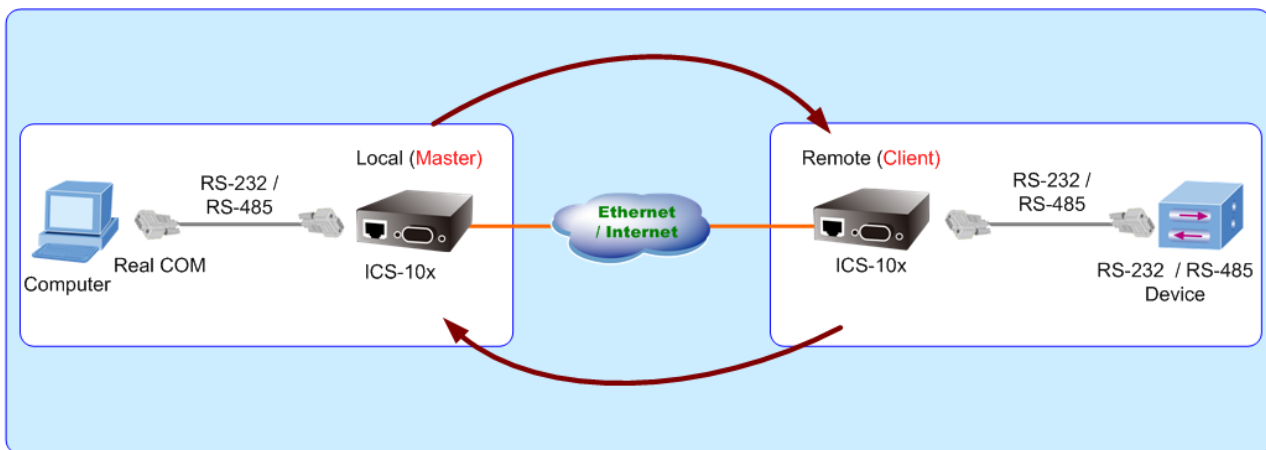

Figure 4-46 Pair Connection mode

In effect, this converter will be acting as a TCP server. The screen in Figure 4-47 appears. When the changed operation mode, the user should be changed the Serial Port Configuration.

Operation Mode Configuration

Serial Port Operating Mode Pair Connection - Local(Master)

TCP Port Number	<input type="text" value="23"/>	Value = 1024~65535
Inactive Timeout	<input type="text" value="20"/>	Minute (0=Disable)

Figure 4-47 Pair Connection – Local (Master) Configuration screen

<ul style="list-style-type: none"> • TCP Port Number 	<p>The TCP port that ICS-10x uses to listen to connections and that other device must use to contact ICS-10x. To avoid conflicts with well known TCP ports, the default is set to “23”.</p>
<ul style="list-style-type: none"> • Inactive Timeout 	<p>Use the parameter to set an inactive timeout. The unit drops the connection if there is no activity on the serial line before the set time expires. To disable the inactive timeout enter “0”.</p>

4.4.7 Pair Connection – Remote Mode

The parameter defines the maintenance status for listen for the pair connection. In effect, this converter will be acting as a TCP client. The screen in Figure 4-48 appears.

When the changed operation mode, the user should be changed the Serial Port Configuration.

Figure 4-48 Pair Connection – Remote (Slave) Configuration screen

• Remote Host IP Address	Allow the ICS-10x to connect actively to the remote host whose IP address is set by this parameter.
• Remote Host Port Number	The TCP port that ICS-10x uses to listen to connections and that other device must use to contact ICS-10x. To avoid conflicts with well known TCP ports, the default is set to “23”.
• Inactive Timeout	Use the parameter to set an inactive timeout. The unit drops the connection if there is no activity on the serial line before the set time expires. To disable the inactive timeout enter “0”.

Important!

While using Pair Connection mode for two RS-232 services distance extend, the DB9/RS-232 cables are very importance in this application. There are much kind of RS-232 cables, such as **straight cable** (standard) and **Null-Modem cable**. Please make sure the DB9/RS-232 cables match the below constriction:

- **Serial Device to ICS-10x/Remote (Slave)** – Use the original RS-232 serial cable attached in the serial device package.
- **Host / Client to ICS-10x/Local (Master)** – It has to use the **Null-Modem cable!**

Users can use the Null-Modem cable directly connect to the ICS-10x (Master), or use the Null-Modem DB9 connector, as the picture shows:

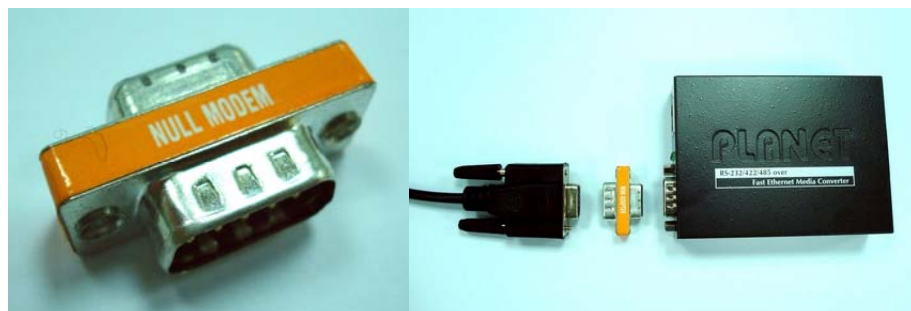

Once the Pair Connection mode of two ICS-10x be correctly configured but still fail link, check the RS-232 cables!

Example: Two ICS-10x with Pair Connection mode
One be configured as Pair Connection – Local (Master)
The other one be configured as Pair Connection – Remote (Slave)

Via the RS-485 interface, the external scanners, speed dome cameras and PTZ receivers can be controlled by the keyboard which provides upward, downward, leftward, rightward, clockwise and counterclockwise with the joystick. In this case, we use two ICS-10x to extend the distance between an IP surveillance PT Camera and a Control keyboard. Both of the two equipments are implemented with RS-485 interface.

The two of the ICS-10x master and slave with below settings:

ICS-10x Master	
Connect to	Control Keyboard
IP Address / Subnet Mask	192.168.0.100 / 255.255.255.0
Operation Mode	Mode: Pair Connection – Local TCP Port Number : 1024
Serial Port Configuration	Serial Mode: RS-485 Baudrate: 9600 Character Bits: 8 Parity Type : none Stop Bit : 1 Hardware Flow Control: none
ICS-10x Slave	
Connect to	Speed Dome Camera, PTZ or Scanner
IP Address / Subnet Mask	192.168.0.101 / 255.255.255.0
Operation Mode	Mode: Pair Connection – Remote Remote Host IP Address : 192.168.0.100 Remote Host Port Number : 1024
Serial Port Configuration	Serial Mode: RS-485 Baudrate: 9600 Character Bits: 8 Parity Type : none Stop Bit : 1 Hardware Flow Control: none

Topology:

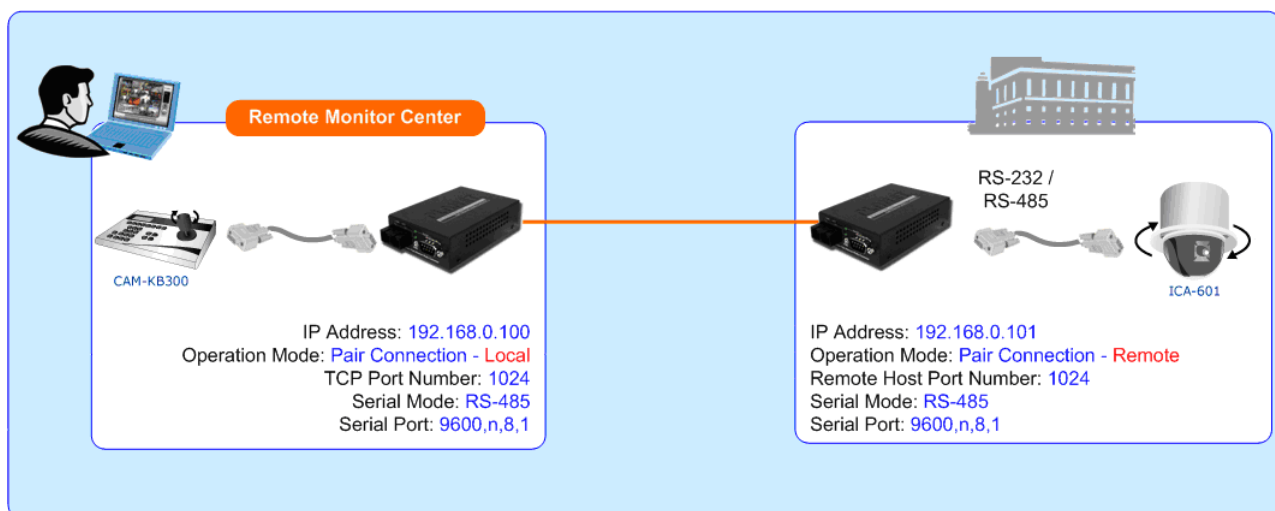

Figure 4-49 Two ICS-10x configured with Pair-Connection

1. Connect the converter with the IP camera for RS-485 interface like PLANET product: "ICA-652".
2. Connect the converter with the control keyboard for RS-485 interface like PLANET product: "CAM-KB300".

ICS-10x – Master: be configured as Pair-Connection-Local

3. From Web interface, login the ICS-10x with IP address = 192.168.0.100, set up the operation mode of this unit to be "Pair Connection-Local (master)"

Operation Mode Configuration	
Serial Port Operating Mode: Pair Connection - Local(Master) ▼	
Support Protocol	<input type="checkbox"/> Reverse Telnet
TCP Port Number	1024 Suggest Value = 1024~65535
Inactive Timeout	20 Minute (0=Disable)
Apply	

Figure 4-50 Pair Connection – Local, operation mode configuration

4. Set the Serial Port mode of ICS-10x-Master to RS-485.

Serial Port Configuration	
Item	Setting
Mode	RS485 ▼
Baudrate	9600 ▼
Character Bits	8 ▼
Parity Type	none ▼
Stop Bit	1 ▼
Hardware Flow Control	none ▼
Uart Memory Overflow count	0M,0K,0Byte
Uart FIFO Overflow count	0times
Delimiter	<input type="checkbox"/> Character 1: C8 <input type="checkbox"/> Character 2: B5 <input type="checkbox"/> Silent time: 102 sec <input type="checkbox"/> Drop Character
Update	

Figure 4-51 Pair Connection – Local, serial port configuration

ICS-10x – Slave: be configured to Pair-Connection-Remote

- From Web interface, login the ICS-10x with IP address = 192.168.0.101, set up the operation mode of this unit to be “Pair Connection-Remote (Slave)”

Operation Mode Configuration	
Serial Port Operating Mode	Pair Connection - Remote(Slave) ▼
Remote Host IP Address	0 . 0 . 0 . 0
Remote Host Port Number	1024 Suggest Value = 1024~65535
Inactive Timeout	20 Minute (0=Disable)
Apply	

Figure 4-52 Pair Connection –Remote, operation mode configuration

- Set the Serial Port mode of ICS-10x-Slave to RS-485.

Serial Port Configuration	
Item	Setting
Mode	RS485 ▼
Baudrate	9600 ▼
Character Bits	8 ▼
Parity Type	none ▼
Stop Bit	1 ▼
Hardware Flow Control	none ▼
Uart Memory Overflow count	0M,0K,0Byte
Uart FIFO Overflow count	0times
Delimiter	<input type="checkbox"/> Character 1: C8
	<input type="checkbox"/> Character 2: B5
	<input type="checkbox"/> Silent time: 102 sec
	<input type="checkbox"/> Drop Character
Update	

Figure 4-51 Pair Connection – Local, serial port configuration

- The control keyboard can remote control the IP camera.

4.5 Serial Port Configuration

The page shows the converter's serial Port configuration. The screen in Figure 4-52 appears.

Item	Setting
Mode	RS232
Baudrate	9600
Character Bits	8
Parity Type	none
Stop Bit	1
Hardware Flow Control	none
Uart Memory Overflow count	0M,0K,0Byte
Uart FIFO Overflow count	0times
Delimiter	<input type="checkbox"/> Character 1: C8 <input type="checkbox"/> Character 2: B5 <input type="checkbox"/> Silent time: 102 sec <input type="checkbox"/> Drop Character

Figure 4-52 Serial Port Configuration page screen

The page includes the following fields:

• Mode	From the drop-down menu, select the serial port mode: <ul style="list-style-type: none"> ■ RS-232 ■ RS-422 ■ RS-485
• Baudrate	The unit and attached serial device, such as a modem, must agree on a speed or baud rate to use for the serial connection. Valid baud rates. It's in the range of 300bps to 921600bps .
• Character Bits	Indicates the number of the bits in a transmitted data package. The allowed value is 5,6,7,8 The default is "8" .
• Parity Type	Checks for the parity type. The default value is "none" .
• Stop Bit	The stop bit follows the data and parity bits in serial communication. It indicates the end of transmission. The default is "1" .
• Hardware Flow Control	Flow control manages data flow between devices in a network to ensure it is processed efficiently. Too much data arriving before a device is prepared to manage it causes lost or retransmitted data. The default value is "none" .

<ul style="list-style-type: none">• Delimiter	<p>Character The Character 1 and Character 2 allow the use to enter two ASCII character (in hex format) that delimit the beginning and end of a message. When a message with both there delimiters is received at the serial port, the data contained in the serial buffer is paced in an Ethernet packet and sent out the Ethernet port.</p> <p>Silent Time: For the defined period of time passed, the serial port stops data transmission and close the connection to remote host.</p> <p>Drop Character: If the incoming data contain character 1 or character 2, the packet will be dropped</p> <p>The default value is “Disable”</p>
--	--

4.6 SMTP

The page shows SMTP configuration. The screen in Figure 4-53 appears. You may setup SMTP mail parameters for further operation. If users want to send the alarm message out that contains “Log-Fail Warning”, “OP Change Warning” and “Reboot Warning”, it will need to configure parameters here.



ICS-10X

System	
Network Configuration	
Operation Mode	
Serial Port Configuration	
SMTP	

Logout

SMTP setup

Enable SMTP	<input type="checkbox"/> Enable
SMTP Port	<input type="text" value="25"/>
SMTP server address	<input type="text"/>
SMTP Login Information	<input type="checkbox"/> Enable Username: <input type="text"/> Password: <input type="password"/>
Mail to	<input style="height: 30px; width: 100%;" type="text"/> max: 200
Mail from	<input type="text"/>

Log-Fail Warning

Subject	<input type="text" value="[[ICS-10x]Login Fail Warning"/>
Message Body	<input type="text" value="ICS-10X web Login Fail."/> max: 100

OP Change Warning

Subject	<input type="text" value="[[ICS-10x]Operation Mode Change Warning"/>
Message Body	<input type="text" value="ICS-10X Operation Mode Change."/> max: 100

Reboot Warning

Subject	<input type="text" value="[[ICS-10x]Device Reboot Warning"/>
Message Body	<input type="text" value="ICS-10X Device Reboot."/> max: 100

Figure 4-53 SMTP page screen

The page includes the following fields:

SMTP Setup		
• Enable SMTP	To Enable SMTP function. The default value is “ Disable ”.	
• SMTP Port	Set port number of SMTP service. The default number is “ 25 ”.	
• SMTP Server Address	Type the SMTP server name or the IP address of the SMTP server address.	
• SMTP Login Information	Enable	If authentication is required when an e-mail is sent
	Username	Enter your login name for the SMTP Server.
	Password	Enter your password for the SMTP Server.
• Mail to	Enter the receiver's e-mail address.	
• Mail from	Enter the sender's e-mail address. This address is used for reply e-mails.	
Log-Fail Warning		
• Subject	Enter the subject/title of the e-mail. The default subject is “[ICS-10x]Login Fail Warning”.	
• Message Body	Enter the message of the e-mail. The default subject is “ICS-10x web Login Fail.”.	
OP Change Warning		
• Subject	Enter the subject/title of the e-mail. The default subject is “[ICS-10x]Operation Mode Change Warning”.	
• Message Body	Enter the message of the e-mail. The default subject is “ICS-10x Operation Mode Change.”.	
Reboot Warning		
• Subject	Enter the subject/title of the e-mail. The default subject is “[ICS-10x]Device Reboot Warning”.	
• Message Body	Enter the message of the e-mail. The default subject is “ICS-10x Device Reboot.”.	

■ Logout

Press this function; the web interface will go back to login screen. The screens in Figure 4-54 and Figure 4-55 appear.

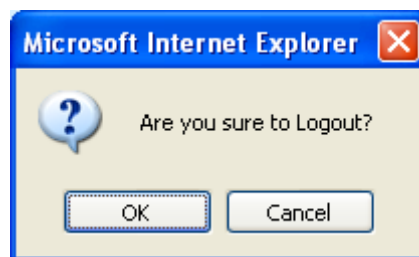

Figure 4-54 Logout dialogues screen

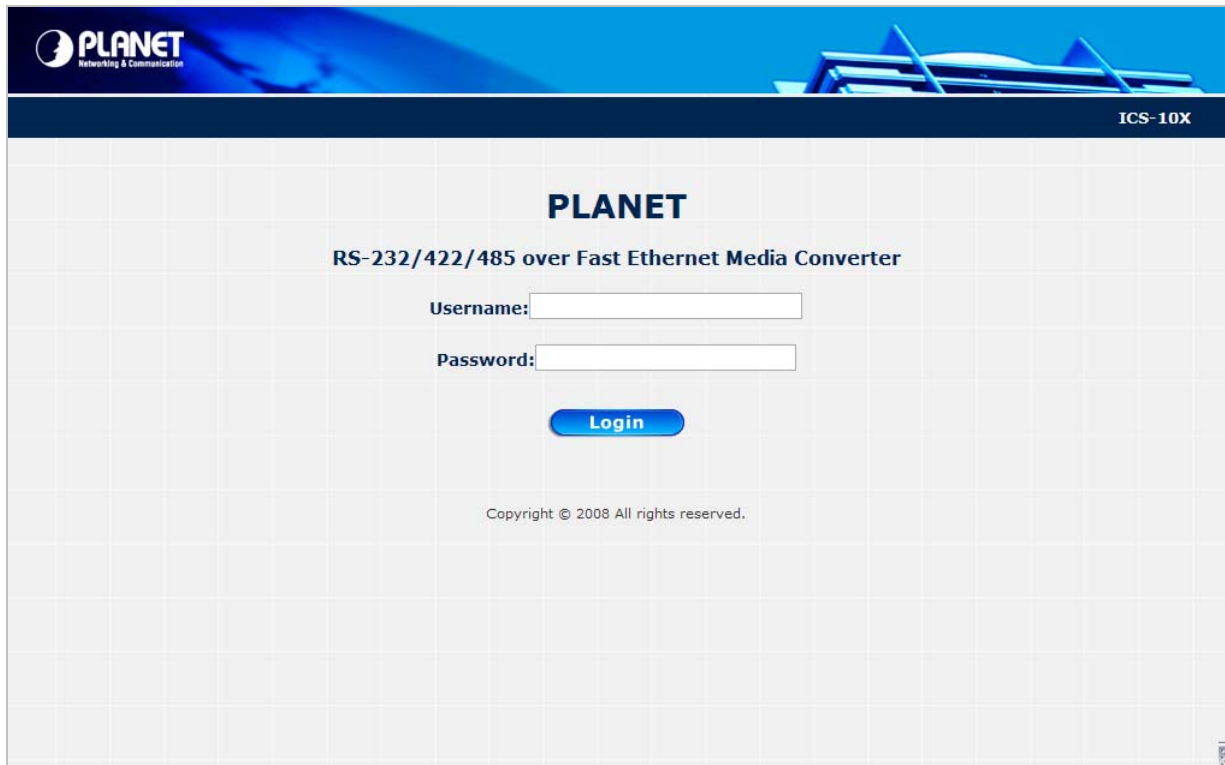

Figure 4-55 Login screen

5. SOFTWARE VCOM UTILITY

The ICS-10x Web Smart Media Converter provides software for Converter smart function configuration when the Converter operation mode on "Virtual COM". - They can be configured through the Console. Two function groups are provide to easy used, can search device and create virtual COM to view as the console port.

This program will search ICS-10x Series devices atomically and shows the information of the device. User can use VCOM function to create virtual COM port for using. User can send and transfer data via virtual COM port.

The VCOM is an integrated software suite that bundles Device Server Administrator and IP Serial Library, and provides something you need to monitor your ICS-10x from a remote location.

5.1 Installing the VCOM Utility

1. Insert the bundled CD disk into the CD-ROM drive to launch the autorun program. Once completed, a welcome menu screen will appear. Click the "VCOM" hyperlink, the below InstallShield Wizard dialog box will appear.

NOTE: If the welcome screen does not appear, click "Start" at the taskbar. Then, select "Run" and type "D:\Software\PLANET VCOM Utility_v3.6.3\VCOMSETUP.exe", assume "D" is your CD-ROM drive.

2. Once the Setup program starts running, please click "Next" button for starting installation.

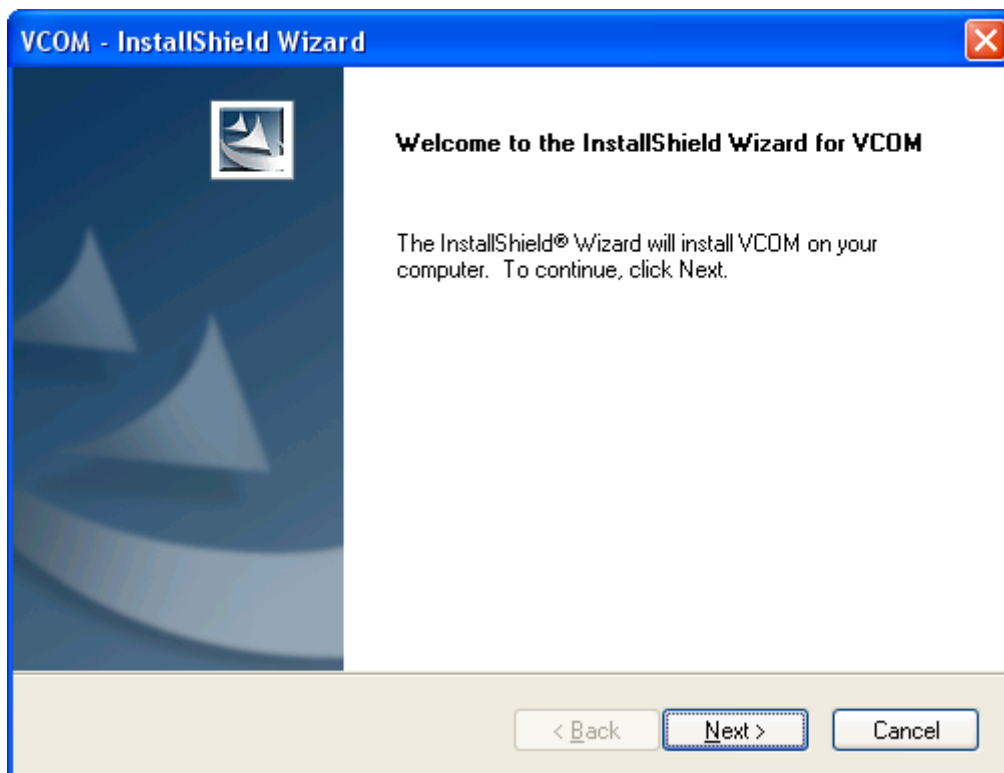

Figure 5-1 VCOM installation screen

3. Click **"Install"** to install the program.

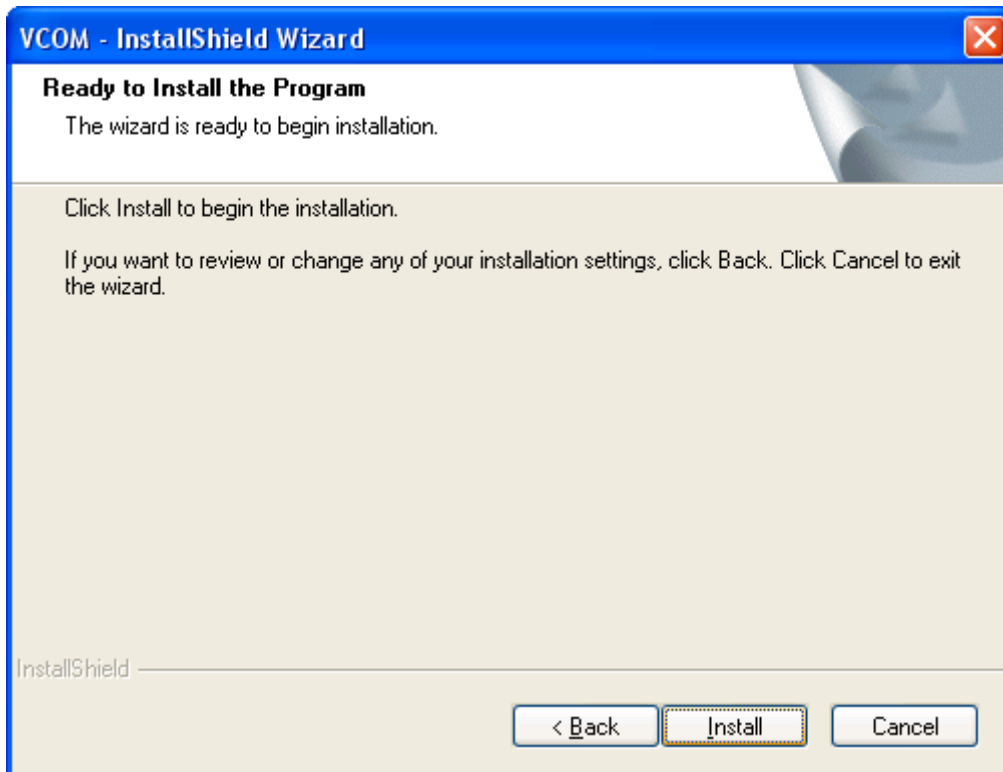

Figure 5-2 VCOM installation screen

4. Click **"Finish"** to complete

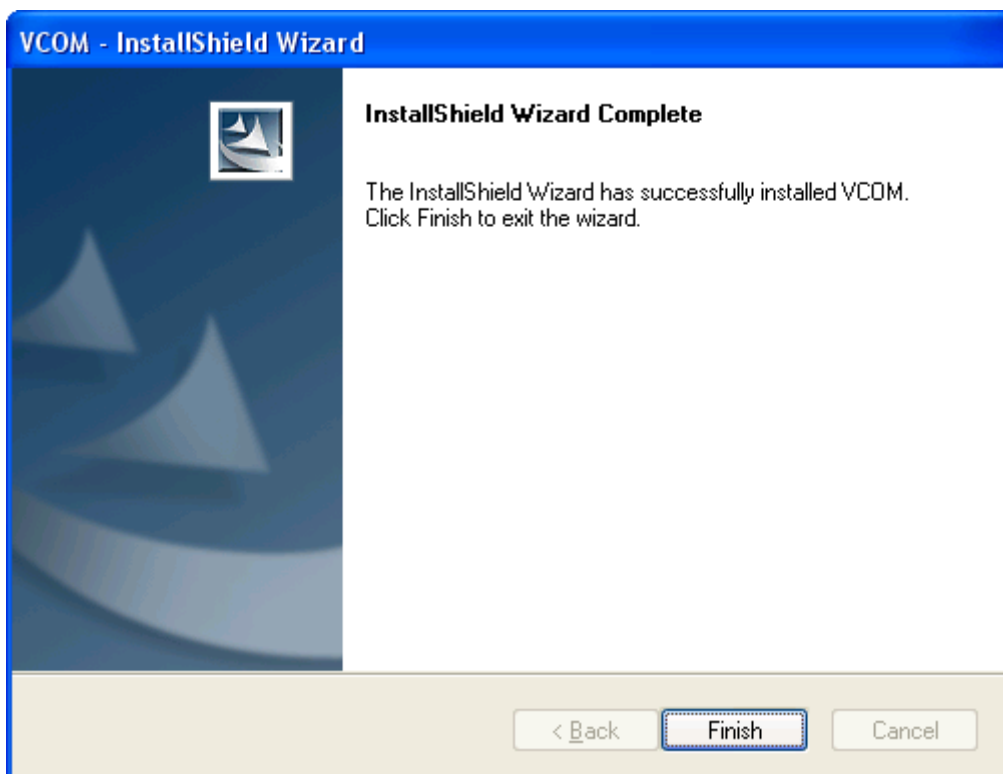

Figure 5-3 VCOM installation screen

5. To run the PLANET VCOM utility on the computer, click “Start” \ “All Programs” \ “PLANET” \ “VCOM” \ “VCOM”

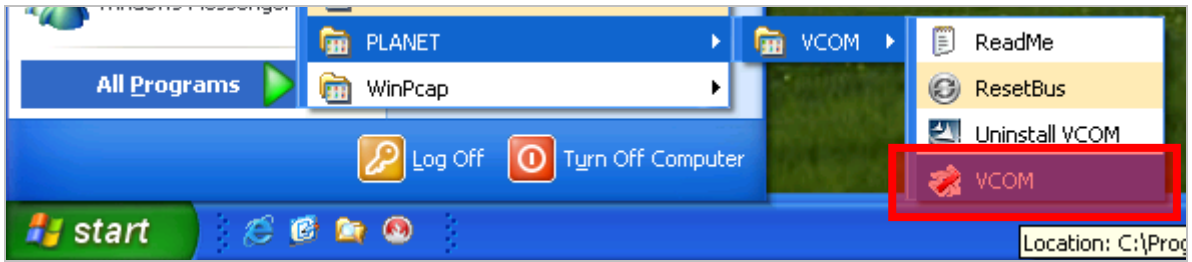

Figure 5-4 VCOM program path

5.2 Search the Device

Click the **Search** button to find the ICS-10x. It will show the ICS-10x device name, project number, MAC address and IP address.

1. Click the shortcut of **VCOM** on the desktop to run the VCOM program.
2. Click "**Search**" button in Main window. If any ICS-10x series device on the LAN, it will show the device name in the Searching window. User can click the device name and it will show device information in the list report.

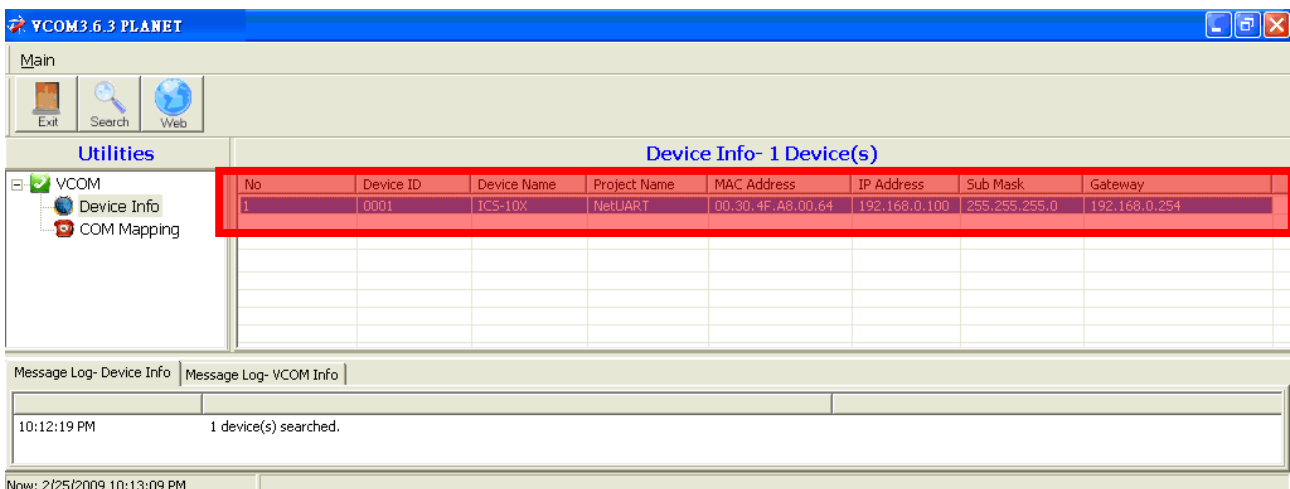
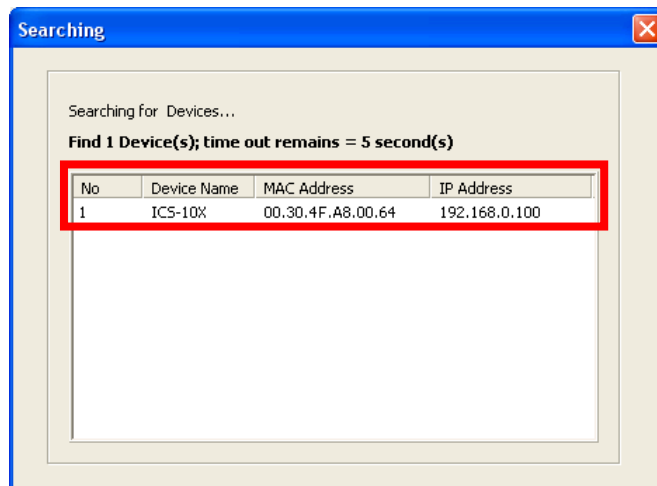
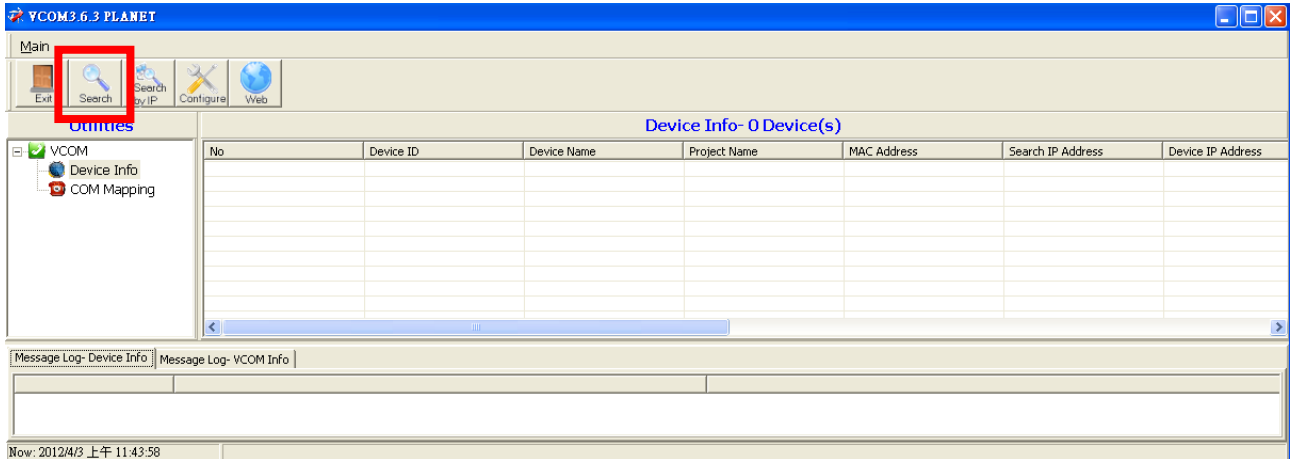

Figure 5-5 VCOM Device Search

5.3 Virtual COM

This function should be set the ICS-10x's operation mode to "Virtual COM" on the Web.
Choose to create port like below:

1. If the device support Telnet, while user click "**COM Mapping**".

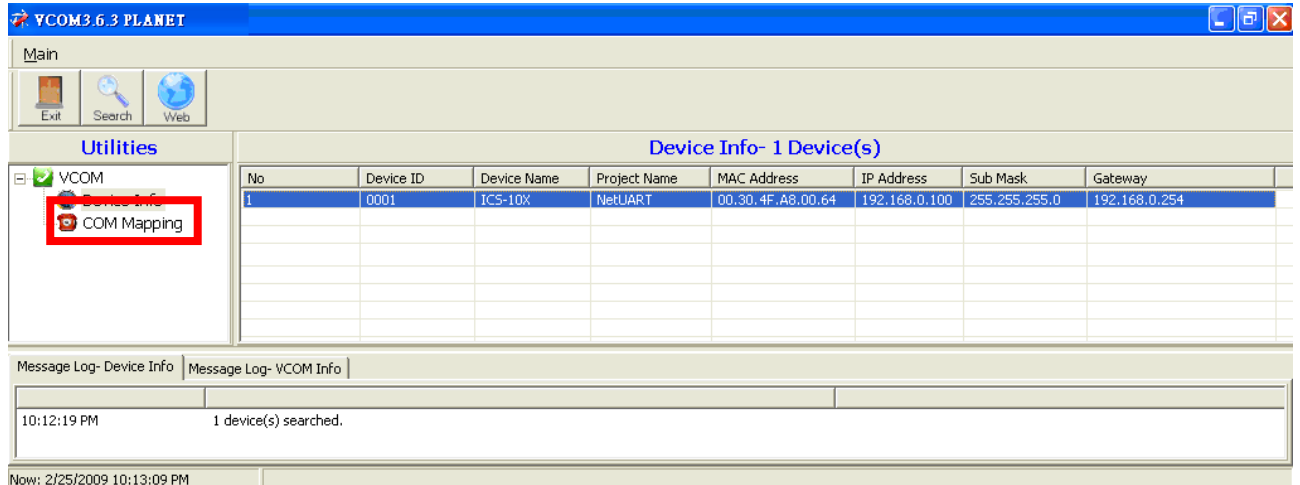

Figure 5-6 COM Mapping

2. While user click "**Add**" button, it will fill IP Address and Port number automatically.

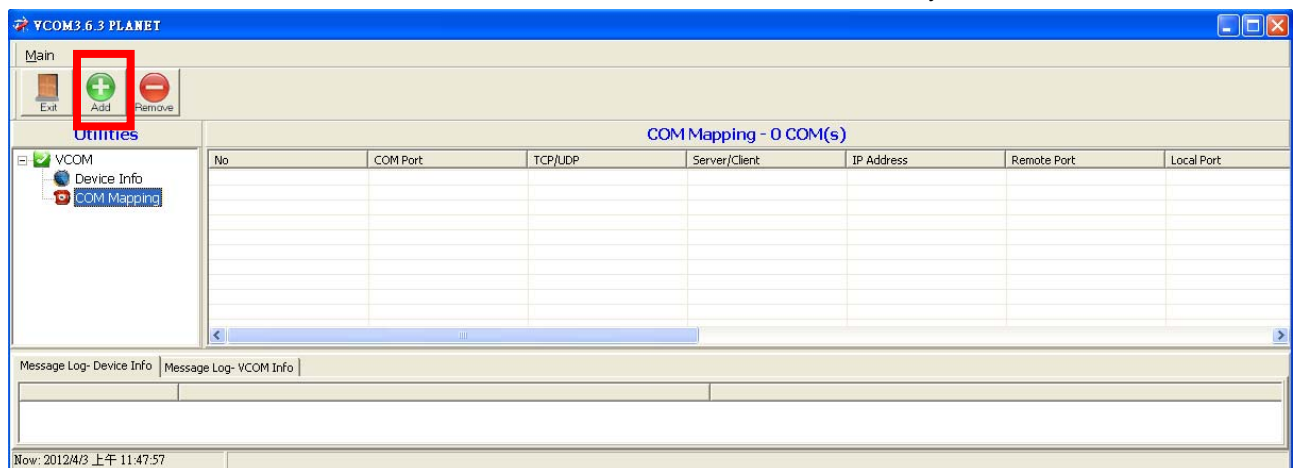

Figure 5-7 Add Virtual COM Port

3. Select device which user want and set up "TCP", "Client" mode, "COM" number and "RemotePort" number. Click "OK" button to create new virtual com port and establish telnet connection

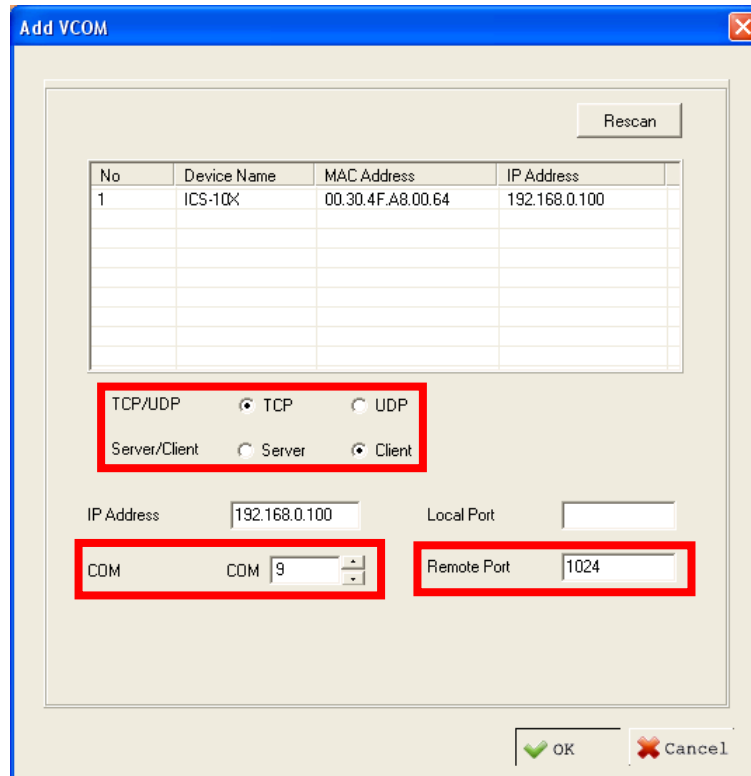

Figure 5-8 Add Virtual COM Port Configuration

4. Then set the **HyperTerminal** parameter



Figure 5-9 Hyper Terminal Configuration

5. then the VCOM will show connect information like below:

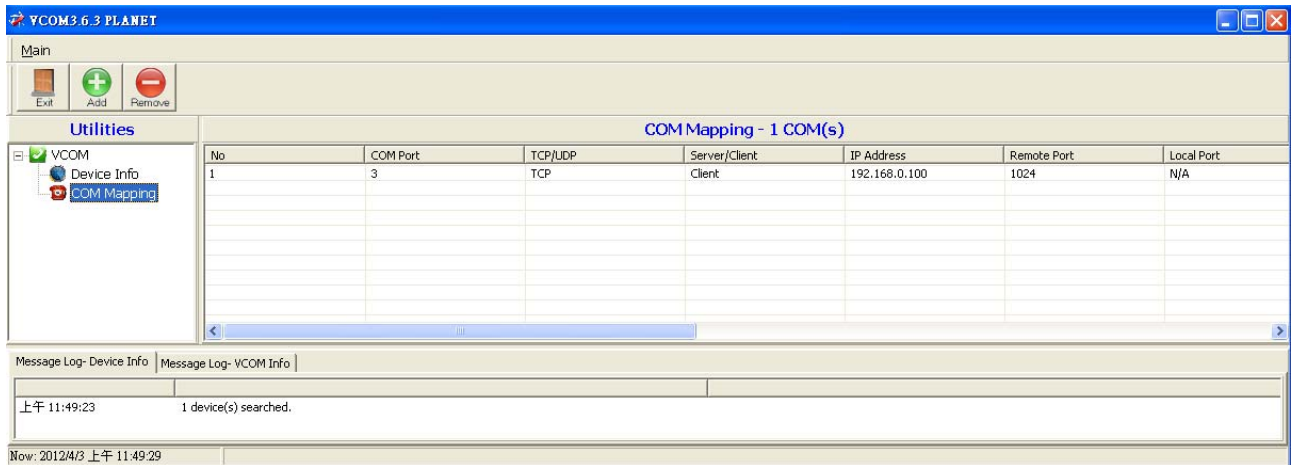

Figure 5-10 VCOM Configuration

6. Once the Virtual COM Port- COM9 connection is established, from the Windows Device Manager, a COM Port is added to the device list.

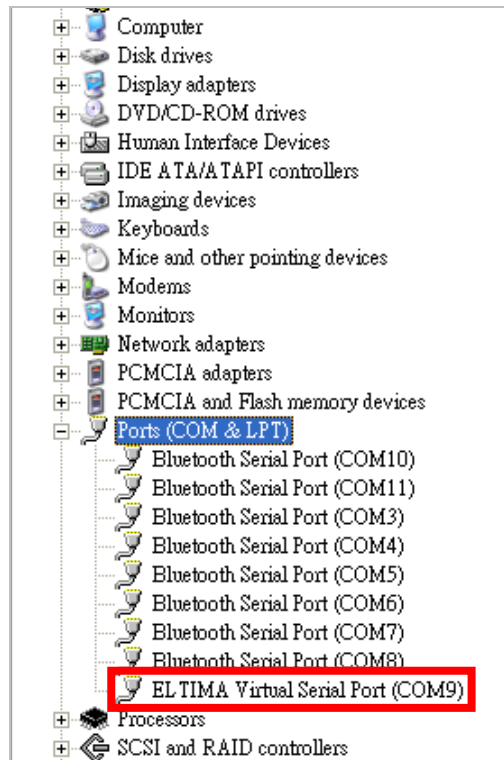

Figure 5-11 Windows Device Server - Virtual COM Port



Note

When the Virtual COM program creates COM port, the Device Manager will add "Virtual Serial Port". And delete the Port on the VCOM, the device will disappear.

APPENDIX A

A.1 PLANET Smart Discovery Utility

For easily list the ICS-10x in your Ethernet environment, the Planet Smart Discovery Utility from user's manual CD-ROM is an ideal solution.

The following install instructions guiding you for run the Planet Smart Discovery Utility.

1. Deposit the Planet Smart Discovery Utility in administrator PC.
2. Run this utility and the following screen appears.

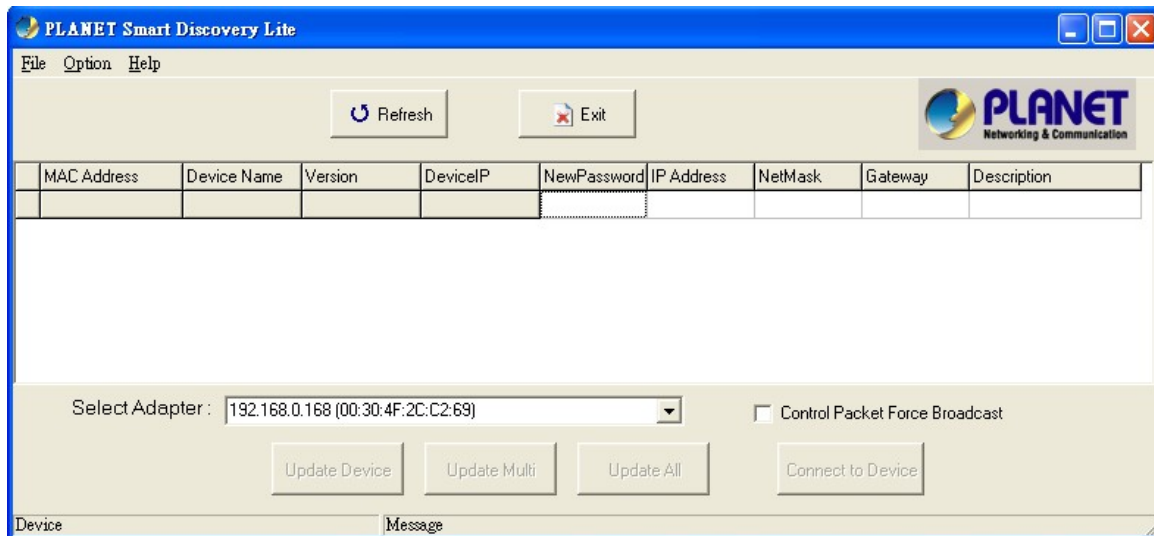

Figure A-1 Planet Smart Discovery Utility Screen



If there are two LAN cards or above in the same administrator PC, choose different LAN card by use the “**Select Adapter**” tool.

3. Press “**Refresh**” button for list current connected devices in the discovery list, the screen is shown as follow.

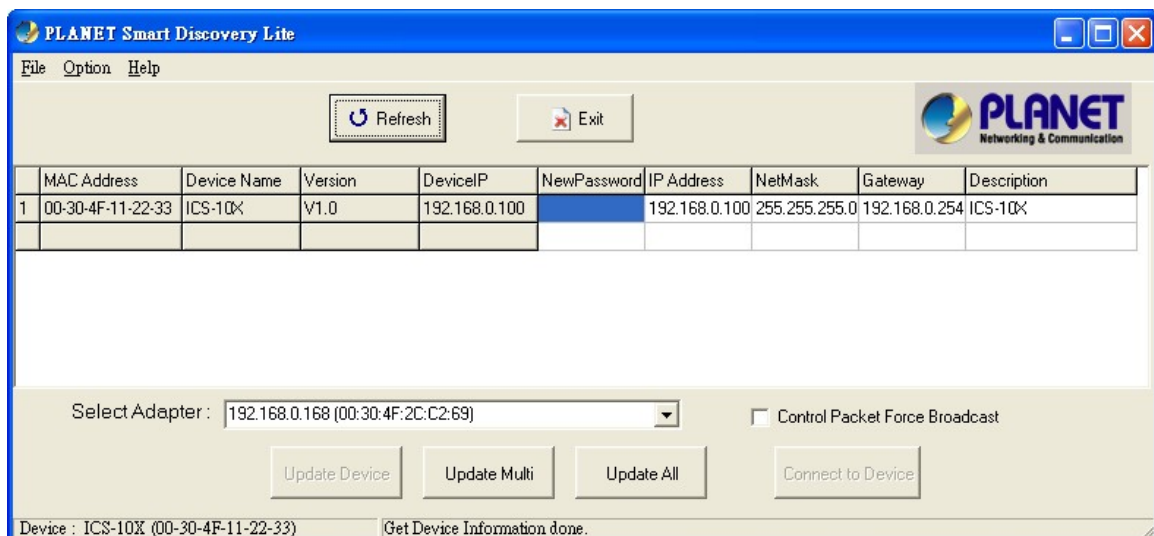

Figure A-2 Planet Smart Discovery Utility Screen

1. This utility show all necessary information from the devices, such as MAC Address, Device Name, firmware version, Device IP Subnet address, also can assign new password, IP Subnet address and description for the devices.
2. After setup completed, press "**Update Device**", "**Update Multi**" or "**Update All**" button to take affect. The meaning of the 3 buttons above are shown as below:

Update Device: use current setting on one single device.

Update Multi: use current setting on choose multi-devices.

Update All: use current setting on whole devices in the list.

The same functions mentioned above also can be finding in "**Option**" tools bar.

3. To click the "**Control Packet Force Broadcast**" function, it can allow assign new setting value to the Web Smart Switch under different IP subnet address.
6. Press "**Connect to Device**" button then the Web login screen appears.
7. Press "**Exit**" button to shutdown the planet Smart Discovery Utility.

A.2 Device's RS-232/RS-422/RS-485 Pin Assignments

➤ DB9 Pin Define for RS-232 / RS-422 / RS-485

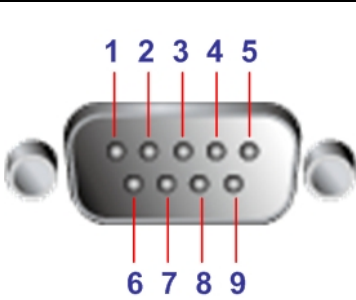
	DB9-PIN	RS-232	RS-422/485 4-wire	RS-485 2-wire
	1	DCD		
	2	RXD		
	3	TXD		
	4	DTR	RX-	Data B(-)
	5	GND		
	6	DSR	TX-	
	7	RTS	RX+	Data A(+)
	8	CTS	TX+	
	9	RI		

A.3 Device's RJ-45 Pin Assignments

■ 10/100Mbps, 10/100Base-TX

Contact	MDI	MDI-X
1	1 (TX +)	3
2	2 (TX -)	6
3	3 (RX +)	1
6	6 (RX -)	2
4, 5, 7, 8	Not used	Not used

Implicit implementation of the crossover function within a twisted-pair cable, or at a wiring panel, while not expressly forbidden, is beyond the scope of this standard.

A.4 RJ-45 cable pin assignment

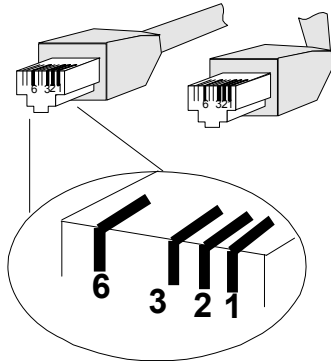

There are 8 wires on a standard UTP/STP cable and each wire is color-coded. The following shows the pin allocation and color of straight cable and crossover cable connection:

Straight Cable		SIDE 1	SIDE2
<p>SIDE 1</p> <p>SIDE 2</p>	<p>1 = White / Orange</p> <p>2 = Orange</p> <p>3 = White / Green</p> <p>4 = Blue</p> <p>5 = White / Blue</p> <p>6 = Green</p> <p>7 = White / Brown</p> <p>8 = Brown</p>	<p>1 = White / Orange</p> <p>2 = Orange</p> <p>3 = White / Green</p> <p>4 = Blue</p> <p>5 = White / Blue</p> <p>6 = Green</p> <p>7 = White / Brown</p> <p>8 = Brown</p>	
Straight Cable		SIDE 1	SIDE2
<p>SIDE 1</p> <p>SIDE 2</p>	<p>1 = White / Orange</p> <p>2 = Orange</p> <p>3 = White / Green</p> <p>4 = Blue</p> <p>5 = White / Blue</p> <p>6 = Green</p> <p>7 = White / Brown</p> <p>8 = Brown</p>	<p>1 = White / Orange</p> <p>2 = Green</p> <p>3 = White / Orange</p> <p>4 = Blue</p> <p>5 = White / Blue</p> <p>6 = Orange</p> <p>7 = White / Brown</p> <p>8 = Brown</p>	

Figure A-1: Straight-Through and Crossover Cable

Please make sure your connected cables are with same pin assignment and color as above picture before deploying the cables into your network.

A.5 Fiber Optical Cable Connection Parameter

The wiring details are as below:

■ Fiber Optical patch Cables: (For ICS-102 / ICS-102S / ICS-105A)

Model	Standard	Fiber Type	Cable Specification
ICS-102	100Base-FX Wavelength (1300nm)	Multi-mode	50/125μm or 62.5/125μm
ICS-102S	100Base-FX Wavelength (1310nm)	Single-mode	9/125μm
ICS-105A	100Base-FX Wavelength (Depend on SFP module)	Multi-mode Single-mode	50/125μm or 62.5/125μm 9/125μm

A.6 Power Information

The power jack of ICS-10X is with 2.5mm in the central post and required +5VDC power input. It will conform to the bundled AC-DC adapter and Planet's Media Chassis. Should you have the problem to make the power connection, please contact your local sales representative.

Please keep the AC-DC adapter as spare parts when your ICS-10X is installed to a Media Chassis.

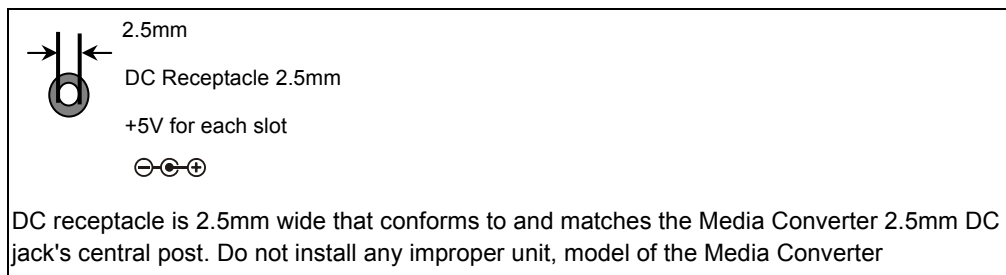

2080-AA3600-005



EC Declaration of Conformity

For the following equipment:

*Type of Product: RS-232/RS-422/RS-485 over Fast Ethernet Media Converter

*Model Number: ICS-100, ICS-102, ICS-102S15, ICS-105A

* Produced by:

Manufacturer's Name : **Planet Technology Corp.**

Manufacturer's Address: 10F., No.96, Minquan Rd., Xindian Dist.,
New Taipei City 231, Taiwan (R.O.C.)

is herewith confirmed to comply with the requirements set out in the Council Directive on the Approximation of the Laws of the Member States relating to Electromagnetic Compatibility Directive on (2004/108/EC).

For the evaluation regarding the EMC, the following standards were applied:

EN 55022	(Class A: 2010)
EN 61000-3-2	(2006 + A2:2009)
EN 61000-3-3	(2008)
EN 55024	(2010)
EN 50130-4	(2011)
IEC 61000-4-2	(2008)
IEC 61000-4-3	(2006 + A1:2007 + A2 :2010)
IEC 61000-4-4	(2004 + A1:2010)
IEC 61000-4-5	(2005)
IEC 61000-4-6	(2008)
IEC 61000-4-8	(2009)
IEC 61000-4-11	(2004)

Responsible for marking this declaration if the:

Manufacturer Authorized representative established within the EU

Authorized representative established within the EU (if applicable):

Company Name: **Planet Technology Corp.**

Company Address: **10F., No.96, Minquan Rd., Xindian Dist., New Taipei City 231, Taiwan (R.O.C.)**

Person responsible for making this declaration

Name, Surname **Kent Kang**

Position / Title : **Product Manager**

Taiwan
Place

24 April, 2012
Date

Legal Signature

PLANET TECHNOLOGY CORPORATION

e-mail: sales@planet.com.tw http://www .planet.com.tw

10F., No.96, Minquan Rd., Xindian Dist., New Taipei City, Taiwan, R.O.C. Tel:886-2-2219-9518 Fax:886-2-2219-9528