

Ethernet over VDSL2 Converter

VC-201A / VC-204

User's Manual

Trademarks

Copyright © PLANET Technology Corp. 2009

Contents subject to revision without prior notice.

PLANET is a registered trademark of PLANET Technology Corp. The information in this manual is subject to change without notice. All other trademarks belong to their respective owners.

Disclaimer

PLANET Technology does not warrant that the hardware will work properly in all environments and applications, and makes no warranty and representation, either implied or expressed, with respect to the quality, performance, merchantability, or fitness for a particular purpose.

PLANET has made every effort to ensure that this User's Manual is accurate; PLANET disclaims liability for any inaccuracies or omissions that may have occurred.

Information in this User's Manual is subject to change without notice and does not represent a commitment on the part of PLANET. PLANET assumes no responsibility for any inaccuracies that may be contained in this User's Manual. PLANET makes no commitment to update or keep current the information in this User's Manual, and reserves the right to make improvements to this User's Manual and/or to the products described in this User's Manual, at any time without notice.

If you find information in this manual that is incorrect, misleading, or incomplete, we would appreciate your comments and suggestions.

FCC Warning

This equipment has been tested and found to comply with the

regulations for a Class A digital device, pursuant to Part 15 of the FCC Rules. These limits are designed to provide reasonable protection against harmful interference when the equipment is operated in a commercial environment. This equipment generates, uses, and can radiate radio frequency energy and, if not installed and used in accordance with this user's guide, may cause harmful interference to radio communications. Operation of this equipment in a residential area is likely to cause harmful interference, in which case the user will be required to correct the interference at his own expense.

CE Mark Warning

This is a Class A product. In a domestic environment, this product may cause radio interference, in which case the user may be required to take adequate measures.

WEEE Warning



To avoid the potential effects on the environment and human health as a result of the presence of hazardous substances in electrical and electronic equipment, end users of electrical and electronic equipment should understand the meaning of the crossed-out wheeled bin symbol. Do not dispose of WEEE as unsorted municipal waste and have to collect such WEEE separately.

Revision

Ethernet Over VDSL2 Converter User's Manual

For Models: VC-201A / VC-204

Rev 1.0 (January 2009)

Part No.: 2350-AC0110-000

TABLE OF CONTENTS

1. Introduction.....	5
1.1 Checklist.....	5
1.2 Introduction to Ethernet over VDSL2 Bridge.....	5
1.3 Key Features	9
1.4 Specifications	10
2. Hardware Description	12
2.1 Front Panel.....	12
2.1.1 LED indicators for VC-201A.....	13
2.1.2 LED indicators for VC-204.....	14
2.2 The Rear Panel	16
2.2.1 MODE DIP Switch	16
3. Installing and Using VDSL Converter	19
3.1 Install the Ethernet Over VDSL2 Converter	19
3.1.1 VC-201A / VC-204 LAN to LAN connection.....	20
3.1.2 VC-201A / VC-204 Connect to Multi-Port Master .	20
3.2 Connecting VC-201A / VC-204	21
3.2.1 Connecting Standalone PC.....	21
3.2.2 Connecting Multiple PCs to an Ethernet LAN.....	22
3.3 Chassis Installation and Rack Mounting	24
4. Power Information.....	25
5. Troubleshooting.....	26
6. FAQ	27

1. Introduction

1.1 Checklist

Check the contents of your package for following parts:

- VC-201A / VC-204
- Power Adapter
- RJ-11 Telephone line
- User's Manual

If any of these pieces are missing or damaged, please contact your dealer immediately, if possible, retain the carton including the original packing material, and use them against to repack the product in case there is a need to return it to us for repair.

1.2 Introduction to Ethernet over VDSL2 Bridge

PLANET's state-of-the-art Ethernet-over-VDSL2 products are based on two core networking technologies: Ethernet and VDSL2 (Very-high-data-rate Digital Subscriber Line 2). This technology offers the absolute fastest possible data transmission speeds over existing copper telephone lines without the need for rewiring.

The VC-201A / VC-204 Ethernet Over VDSL2 Converter has a switching architecture with RJ-45 10/100Mbps Ethernet port and one symmetric Ethernet over VDSL port (symmetry means upstream and downstream rate are the same or similar) – the VDSL port can be RJ-11 connectors. The VC-201A / VC-204 can be set to CO mode or CPE mode via a DIP switch. When the VC-20X-CO is used to connect to the other VC-20X-CPE as a standalone pair, up to 100/55Mbps asymmetric data rate within 200m and up to 25/4Mbps asymmetric data rate at 1.6km. This capability is ideal for use as an Ethernet extender for your existing Ethernet network.

PLANET's VDSL2 Converter solution provides a much cheaper replacement and smooth migration for existing Long Reach Ethernet (LRE) networks.

The cable specifications of the connection are listed as following:

- 10BASE-T, Category 3, 4 or 5 UTP
- 100BASE-TX, Category 5 UTP
- Ethernet over VDSL, Twisted-pair telephone wires

The two drawings listed below are typical application for the Ethernet Over VDSL2 Converter.



Note

Slave device (CPE) must connect to Master device (CO) through the telephone wire. Slave cannot connect to Slave and Master cannot connect to Master. To define the VC-201A / VC-204 to CO or CPE, please refer to section 2.2.1 for more detail.

LAN to LAN Connection

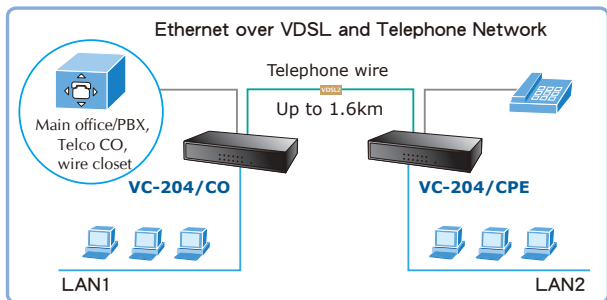
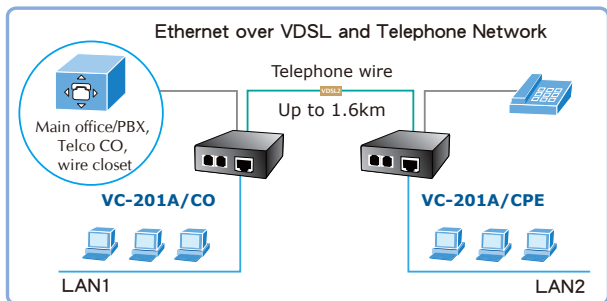
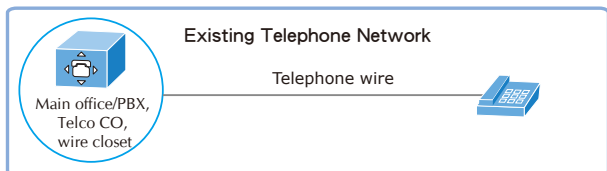

Multi-LAN Connection

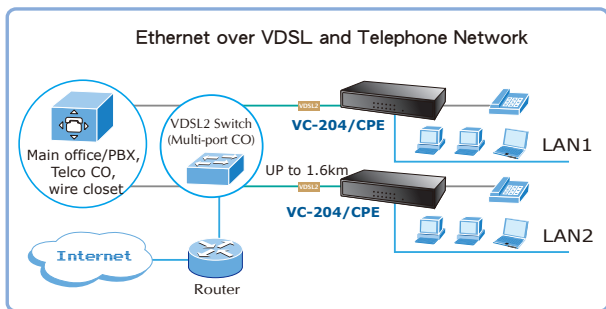
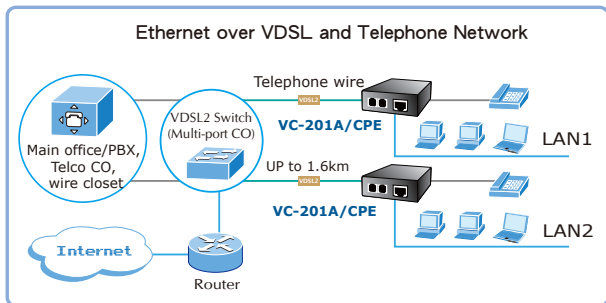
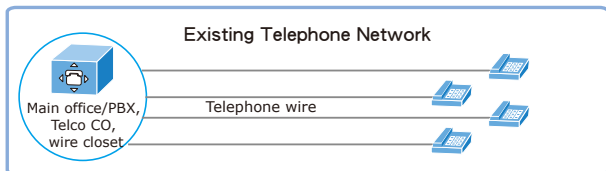

1.3 Key Features

The Ethernet Over VDSL2 Converter provides the following key features:

- Cost-effective VDSL2 CO/CPE bridge solution
- One box design, CO/CPE selectable via DIP Switch
- Defines asymmetric (Plan 998) and symmetric (Plan 997) band plans for the transmission of upstream and downstream signals
- Complies with IEEE 802.3, IEEE 802.3u and IEEE 802.3x standards
- DMT (Discrete Multi-Tone) line coding
- Half duplex Back pressure and IEEE 802.3x Full Duplex Pause frame flow control
- Built-in POTS splitter to share voice and data
- Voice and data communication can be shared on the existing telephone wire simultaneously
- Support up to 1536 bytes packet size, 802.1Q VLAN tag transparent
- VDSL2 stand-alone transceiver for simple bridge modem application
- Selectable target band plan and target SNR margin
- Support extensive LED indicators for network diagnostics

1.4 Specifications

Product		VC-201A	VC-204
Hardware Specification			
Ports	10/100Base-TX	1 RJ-45, Auto-negotiation and Auto-MDI/MDI-X	4 RJ-45, Auto-negotiation and Auto-MDI/MDI-X
	VDSL	1 RJ-11, female Phone Jack	
	PHONE	1 RJ-11, Built-in splitters for POTS connection	
DIP Switch		4 position DIP switch	
Functionality		<ul style="list-style-type: none"> • CO / CPE mode select • Selectable fast and interleaved mode • Selectable target Band Plan • Selectable target SNR mode 	
Encoding		<ul style="list-style-type: none"> • VDSL-DMT - ITU-T G.993.1 VDSL - ITU-T G.997.1 - ITU-T G.993.2 VDSL2 (Profile 17a) 	
LED Indicators		<ul style="list-style-type: none"> • One Power, • 3 for RJ-11/VDSL2: • 2 for per RJ-45 10/100Base-TX port 	<ul style="list-style-type: none"> • One Power, • 4 for RJ-11/VDSL2: • 1 for per RJ-45 10/100Base-TX port
Cabling	Ethernet	<ul style="list-style-type: none"> • 10Base-T: 2-pair UTP Cat.3,4,5 up to 100m (328ft) • 100Base-TX: 2-pair UTP Cat.5, up to 100m (328ft) 	
	VDSL	Twisted-pair telephone wires (AWG24 or better) up to 1.6km	

Performance* (Down Stream / Up Stream)	Asymmetric Mode	
	200m -> 100/55Mbps	400m -> 90/50Mbps
	600m -> 70/40Mbps	800m -> 60/25Mbps
	1000m -> 45/15Mbps	1200m -> 35/10Mbps
	1400m -> 30/6Mbps	1600m -> 25/4Mbps
	Symmetric Mode	
200m -> 100/100Mbps	400m -> 90/95Mbps	
600m -> 70/70Mbps	800m -> 55/50Mbps	
1000m -> 45/35Mbps	1200m -> 30/25Mbps	
1400m -> 25/20Mbps	1600m -> 20/15Mbps	
Power Requirement	5V DC, 2A	
Operating Temperature	0~50°C	
Storage Temperature	-25~70°C	
Operating Humidity	10% to 90%, relative humidity, non-condensing	
Storage Humidity	10% to 90%, relative humidity, non-condensing	
Standard Conformance		
Regulation Compliance	FCC Part 15 Class A, CE	
Standards Compliance	IEEE 802.3 10Base-T IEEE 802.3u 100Base-TX ITU-T • G.993.1 (VDSL) • G.997.1 • G.993.2 VDSL2 (Profile 17a)	

* The actual data rate will vary on the quality of the copper wire and environment factors.

2. Hardware Description

The VC-201A / VC-204 provides 2 RJ-11 ports for voice connection (like telephone) and for network line connection.

The VC-201A provide 1 RJ-45 ports and VC-204 provide 4 RJ-45 ports for two different running speed –10Mbps, 100Mbps, in the same bridge and automatically distinguish the speed of incoming connection.

This section describes the hardware features of the Ethernet Over VDSL2 Converter. For easier control of the converter, familiarize yourself with its display indicators, and ports. Front panel illustrations in this chapter display the unit LED indicators. Before connecting any network device to the converter, read this chapter carefully.

2.1 Front Panel

The units' front panel provides a simple interface monitoring the Ethernet Over VDSL2 Converter.

■ VC-201A Front Panel

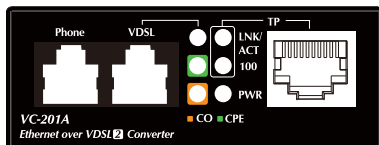

Figure 2-1: VC-201A front panel

■ VC-204 Front Panel



Figure 2-2: VC-204 front panel

2.1.1 LED indicators for VC-201A

The rich diagnostic LEDs on the front panel can provide the operating status of individual port and whole system.

■ System

LED	Color	Function	
PWR	Green	Lit	Power ON
		Off	Power OFF

■ VDSL

LED	Color	Function	
LNK/ ACT	Green	Lit	Indicate that the VDSL link is established.
		Fast Blink	Indicate that the VDSL link is at training status(about 10 seconds).
		Slow Blink	Indicate that the VDSL link is at idle status.
		Off	Indicate that the port is link down .
CO	Green	Lit	Indicate the VDSL Bridge is running at CO mode.
CPE	Green	Lit	Indicate the VDSL Bridge is running at CPE mode.

■ 10/100Base-TX Port

LED	Color	Function	
LNK/ ACT	Green	Lit	Indicate that the port is link up.
		Blink	Indicate that the Converter is actively sending or receiving data over that port.
		Off	Indicate that the port is link down .
100	Green	Lit	Indicate that the port is operating at 100Mbps .
		Off	Indicate that the port is link down or 10Mbps .

2.1.2 LED indicators for VC-204

The rich diagnostic LEDs on the front panel can provide the operating status of individual port and whole system.

■ System

LED	Color	Function	
PWR	Green	Lit	Power ON
		Off	Power OFF

■ VDSL

LED	Color	Function	
ACT	Green	Lit	Indicate that the VDSL link is established.
		Fast Blink	Indicate that the VDSL link is at training status(about 10 seconds).
		Slow Blink	Indicate that the VDSL link is at idle status.
		Off	Indicate that the port is link down .
Sync	Green	Lit	Indicate that the VDSL link is established.
		Fast Blink	Indicate that the VDSL link is at training status (about 10 seconds).
		Slow Blink	Indicate that the VDSL link is at idle status.
CO	Green	Lit	Indicate the VDSL Bridge is running at CO mode.
CPE	Green	Lit	Indicate the VDSL Bridge is running at CPE mode.

■ 10/100Base-TX Port

LED	Color	Function	
LNK/ ACT	Green	Lit	Indicate that the port is link up.
		Blink	Indicate that the Converter is actively sending or receiving data over that port.
		Off	Indicate that the port is link down .

2.2 The Rear Panel

The rear panel of the Ethernet Over VDSL2 Converter is shown as below.

■ VC-201A Rear Panel

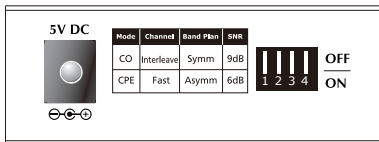

Figure 2-3: VC-201A rear panel

■ VC-204 Rear Panel

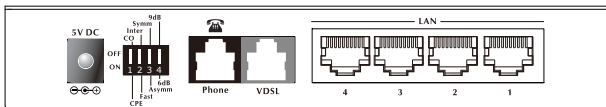

Figure 2-4: VC-204 rear panel

2.2.1 MODE DIP Switch

The Ethernet Over VDSL2 Converter provides 4 selective transmission modes. By switching the transmission modes, you can obtain a best transmission mode to suit with phone line quality or distance of connectivity. The following is the summary table of transmission setting, bandwidth and distance extensibility tested for AWG 24 (0.5mm) twisted-pair without noise and cross talk.

	DIP-1	DIP-2	DIP-3	DIP-4
	Mode	Channel	Band Plan	SNR
OFF	CO	Interleave	Symm	9dB
ON (default)	CPE	Fast	Asymm	6dB

- CO / CPE

- ◆ CO (Central Office) – the Master device mode, usually the CO device will be located at the data center of ISP or enterprise to link to the backbone.
- ◆ CPE (Customer Premises Equipment) – the Slave device mode, usually the CPE device will be located at branch office, home or remote side as the long reach data receiver. The CPE can be connect to the PC, IP Camera or Wireless Access Point and etc network devices.



Note

When the Ethernet Over VDSL2 Converter operate at CPE mode, the DIP switch 2,3,4 is no function.

- Fast and Interleave mode

- ◆ Fast mode guarantees a minimum end to end latency less than 1 ms.
- ◆ Interleaved mode provides impulse noises protection for any impulse noise with a duration less than 250 us. Interleaved mode has a maximum end to end latency of 10m sec.

- Band Plan

- ◆ User has the ability to select Band Plan. When Symmetric is selected that provides better downstream performance, when Asymmetric is selected that provides better upstream performance. Refer to table above for details.

- Target SNR (Signal Noise Ratio) Margin
 - ◆ When fixed SNR margin is selected, the system will maintain the SNR margin at 9 dB across all usable loop length.



Note

By default setting, the four DIP switch at "ON" position and operate as "CPE". For operate as "CO", please adjust the DIP 1 switch as "OFF" position. Adjust other DIP switch setting to fill different network application demand.

Please power off the Ethernet Over VDSL2 Converter, before making any transmission mode adjustment.

2.2.2 DC power jack

VC-201A / VC-204 require 5V DC power input. It will conform to the bundled AC adapter. Should you have the problem to make the power connection, please contact your local sales representative.



Note

1. The device is a power-required device, it means, it will not work till it is powered. If your networks should active all the time, please consider using UPS (Uninterrupted Power Supply) for your device. It will prevent you from network data loss or network down-time.
2. In some area, installing a surge suppression device may also help to protect your Ethernet Over VDSL2 Converter from being damaged by unregulated surge or current to the Ethernet Over VDSL2 Converter or the power adapter.

3. Installing and Using VDSL Converter

3.1 Install the Ethernet Over VDSL2 Converter

The Ethernet Over VDSL2 Converter does not require any software configuration. Users can immediately use any feature of this product simply by attached the cables and plug power on. There is some key limitation on the Ethernet Over VDSL2 Converter. Please check the following items:

- The device is used for Point-to-Point connection only (Master device to Slave device) and allows data and voice work on the same telephone lines.
- VC-201A / VC-204 two RJ-11 connectors for VDSL port. One for voice device connection (like telephone) and the other one for network link connection.
- Depending on the quality of telephone line, the maximum distance of one VDSL segment is 2.0km (6560ft) with AWG 24 telephone wires.
- The distance will change by the quality of telephone wires.

3.1.1 VC-201A / VC-204 LAN to LAN connection

Two sets of the Ethernet Over VDSL2 Converters could be used to link two local Area networks that are located in different place. Through the normal telephone line, it could setup a 100/55Mbps asymmetric backbone, but one Ethernet Over VDSL2 Converter must be Master (CO mode) and the other one is Slave (CPE mode).

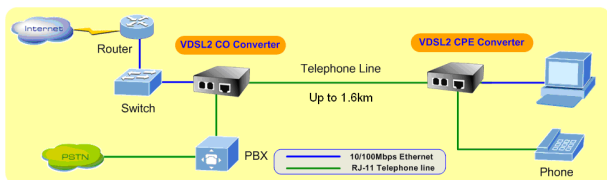

Figure 3-1: VC-201A LAN to LAN connection

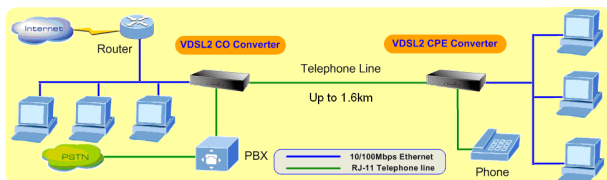

Figure 3-2: VC-204 LAN to LAN connection

3.1.2 VC-201A / VC-204 Connect to Multi-Port Master

In order, to built up a local Internet in apartment, hotel, campus and hospitality environment.

The Multi-port Master (for example, VC-810S VDSL2 Switch) need to be placed in the wiring center (MDF room) and connect

to the telephone line system, on the other hand, need to install a Slave (VC-201A / VC-204 CPE) converter on the individual client side and connect to the Multi-port Master through the telephone lines.

When deciding where to put the converter then you must ensure:

- It is accessible and cables can be connected easily.
- Cabling is away from sources of electrical noise such as radios, transmitters and power lines and fluorescent lighting fixtures.
- Water or moisture can not enter the Converter.
- Air flow around the unit and through the vents in the side of the case is not restricted (company recommend that you provide a minimum of 25mm inch clearance)

To prolong the operational life of your units:

- Do not place objects on top of any unit or stack

3.2 Connecting VC-201A / VC-204

3.2.1 Connecting Standalone PC

Refer to the following procedures to setup the VC-201A to a standalone PC.

1. Set the VC-201A to be CO mode or CPE mode from the DIP switch at the rear panel.
2. Power on the VC-201A by connecting its power source.
3. Power LED will illuminate.
4. Connect VDSL line from another VDSL device to VDSL port of the VC-201A.
5. LNK LED will from blinking to illuminate.

6. Connect telephone to the PHONE port.
7. Connect Ethernet port to PC Network Interface Card (NIC) via regular Cat. 5 cable.

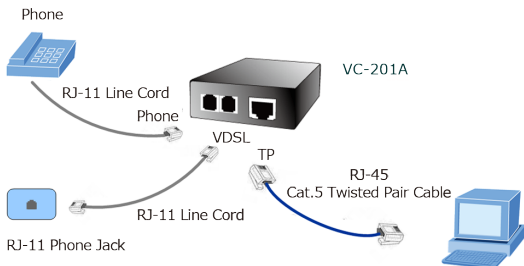

Figure 3-3: Connecting Standalone PC

3.2.2 Connecting Multiple PCs to an Ethernet LAN

Refer to the following procedures to setup the VC-201A / VC-204 to an Ethernet LAN.

1. Set the VC-201A / VC-204 to be CO mode or CPE mode from the DIP switch at the rear panel.
2. Power on the VC-201A / VC-204 by connecting its power source.
3. Power LED will illuminate.
4. Connect VDSL line from another VDSL device to VDSL port of the VC-201A / VC-204.
5. LNK LED will illuminate.
6. Connect telephone to the PHONE port.
7. VC-201A: Connect Ethernet port to Ethernet Switch (or Broad-band Router) via regular Cat. 5 cable.
VC-204: Connect per Ethernet port to each network device via regular Cat 5. cable

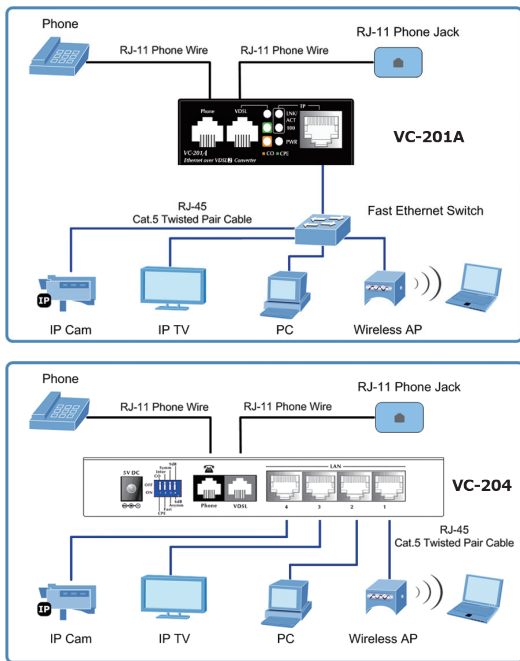

Figure 3-4: Connecting Multiple PCs to an Ethernet LAN



Please refer to your Ethernet device User's Manual for the device's set up information.

3.3 Chassis Installation and Rack Mounting (VC-201A)

To install the Ethernet over VDSL2 Converter in a **10-inch** or **19-inch** Converter Chassis with standard rack, follow the instructions described below.

Step 1: Place your chassis on a hard flat surface, with the front panel positioned towards your front side.

Step 2: Carefully slide in the module until it is fully and firmly fitted into the slot of the converter chassis.



Figure 3-5: Insert a VDSL2 converter into an available slot

Step 3: Attach a rack-mount bracket to each side of the Converter Chassis with supplied screws attached to the package.

Step 4: After the brackets are attached to the Converter Chassis, use suitable screws to securely attach the brackets to the rack

Step 5: Proceed with the steps 4 and steps 5 of session 3.2 **Stand-alone Installation** to connect the network cabling and supply power to your Converter Chassis.



Caution

You must use the screws supplied with the mounting brackets. Damage caused to the parts by using incorrect screws would invalidate your warranty.

4. POWER INFORMATION

The power jack of VC-201A / VC-204 is with 2.5mm in the central post and required +5VDC power input. It will conform to the bundled AC-DC adapter and Planet's Media Chassis. Should you have the problem to make the power connection, please contact your local sales representative.

Please keep the AC-DC adapter as spare parts when your VC-201A / VC-204 is installed to a Media Chassis.



2.5mm

DC Receptacle 2.5mm

+5V for each slot



DC receptacle is 2.5mm wide that conforms to and matches the VDSL2 Converter 2.5mm DC jack's central post. Do not install any improper unit, model of the Ethernet Over VDSL2 Converter

5. Troubleshooting

SYMPTOM:

VDSL LNK LED does not lit after wire is connected to the VDSL port.

CHECKPOINT:

1. Verify the length of the wire connected between two VC-201A / VC-204 is not more than 2.0km. Please also try to adjust the DIP switch or VC-201A / VC-204 to other SNR mode.
2. Please note you must use one VC-201A / VC-204 with CO mode and the other VC-201A / VC-204 with CPE mode, connect to each other to make it work.

SYMPTOM:

TP LED does not lit after cable is connected to the port.

CHECKPOINT:

1. Verify you are using the Cat.5 or better cable with RJ-45 connector to connect to the port.
2. If your device (like LAN card) supports to Auto-Negotiation, please try to manual set at a fixed speed of your device to solve this problem.
3. The converter and the connected device's power are on or not.
4. The port's cable is firmly seated in its connectors in the switch and in the associated device.
5. The connecting cable is good and with correct type.
6. The connecting device, including any network adapter is functional.

6. FAQ

Q1: What voltage that VC-201A / VC-204 used?

A1: 5VDC, 2A

Q2: What is VDSL2?

A2: VDSL2 (Very High-Bit-Rate Digital Subscriber Line 2), G.993.2 is the newest and most advanced standard of xDSL broadband wire line communications.

Designed to support the wide deployment of Triple Play services such as voice, data, high definition television (HDTV) and interactive gaming, VDSL2 enable operators and carrier to gradually, flexibly, and cost efficiently upgrade exiting xDSL-infrastructure.

Q3: What is the best distance for VC-201A / VC-204?

A3: In order to guarantee the stability and better quality of network, so we would suggest the distance in 1.6 kilometer is the best for VC-201A / VC-204.

Q4: What is the best data rate for VC-201A / VC-204?

A4: We provide the data rate of the VC-201A / VC-204 is up to 100Mbps/55Mbps (downstream / upstream) in 200 meters.

Q5: Can VC-201 compatible with VC-201A / VC-204?

A5: Currently NO. Although VC-201 (profile 12a) and VC-201A / VC-204 (profile 17a) are base on ITU-T G.993.2 VDSL2, but with different Profiles, so far they are not compatible with each other.

■

Q6: What is SNR and what's the effect?

A6: In analog and digital communications, Signal-to-Noise Ratio, often written SNR, is a measure of signal strength relative to background noise. The ratio is usually measured in decibels (dB).

In digital communications, the SNR will probably cause a reduction in data speed because of frequent errors that require the source (transmitting) computer or terminal to resend some packets of data. SNR measures the quality of a transmission channel over a network channel. The greater the ratio, the easier it is to identify and subsequently isolate and eliminate the source of noise.

Generally speaking, the higher SNR value gets better line quality, but lower performance.

Q7: What is band plan and what's the effect?

A7: VDSL2 defines multiple band plans and configuration modes (profiles) to allow asymmetric and symmetric services in the same binder (by designated frequency bands) for the transmission of upstream and downstream signals. User has the ability to select fixed band plan. When Symmetric is selected that provides better downstream performance, when Asymmetric is selected that provides better upstream performance.