

User's Manual

IKVM-8010 / IKVM-16010

8/16-Port IP KVM Switch



Copyright

Copyright © 2011 by PLANET Technology Corp., All rights reserved. No part of this publication may be reproduced, transmitted, transcribed, stored in a retrieval system, or translated into any language or computer language, in any form or by any means, electronic, mechanical, magnetic, optical, chemical, manual or otherwise, without the prior written permission of PLANET.

PLANET makes no representations or warranties, either expressed or implied, with respect to the contents hereof and specifically disclaims any warranties, merchantability or fitness for any particular purpose. Any software described in this manual is sold or licensed "as is". Should the programs prove defective following their purchase, the buyer (and not PLANET, its distributor, or its dealer) assumes the entire cost of all necessary servicing, repair, and any incidental or consequential damages resulting from any defect in the software. Further, PLANET reserves the right to revise this publication and to make changes from time to time in the contents hereof without obligation to notify any person of such revision or changes.

All brand and product names mentioned in this manual are trademarks and/or registered trademarks of their respective holders.

Federal Communication Commission Interference Statement

This equipment has been tested and found to comply with the limits for a Class B digital device, pursuant to Part 15 of FCC Rules. These limits are designed to provide reasonable protection against harmful interference in a residential installation. This equipment generates, uses, and can radiate radio frequency energy and, if not installed and used in accordance with the instructions, may cause harmful interference to radio communications. However, there is no guarantee that interference will not occur in a particular installation. If this equipment does cause harmful interference to radio or television reception, which can be determined by turning the equipment off and on, the user is encouraged to try to correct the interference by one or more of the following measures:

1. Reorient or relocate the receiving antenna.
2. Increase the separation between the equipment and receiver.
3. Connect the equipment into an outlet on a circuit different from that to which the receiver is connected.
4. Consult the dealer or an experienced radio technician for help.

FCC Caution

To assure continued compliance, (Example-use only shielded interface cables when connecting to computer or peripheral devices). Any changes or modifications not expressly approved by the party responsible for compliance could void the user's authority to operate the equipment.

This device complies with Part 15 of the FCC Rules. Operation is subject to the Following two conditions:
(1) This device may not cause harmful interference, and (2) this Device must accept any interference received, including interference that may cause undesired operation.

Federal Communication Commission (FCC) Radiation Exposure Statement

This equipment complies with FCC radiation exposure set forth for an uncontrolled environment. In order to avoid the possibility of exceeding the FCC radio frequency exposure limits, human proximity to the antenna shall not be less than 20 cm (8 inches) during normal operation.

Safety

This equipment is designed with the utmost care for the safety of those who install and use it. However, special attention must be paid to the dangers of electric shock and static electricity when working with electrical equipment. All guidelines of this and of the computer manufacture must therefore be allowed at all times to ensure the safe use of the equipment.

CE Mark Warning

This is a Class B product. In a domestic environment, this product may cause radio interference, in which case the user may be required to take adequate measures.

WEEE Regulation



To avoid the potential effects on the environment and human health as a result of the presence of hazardous substances in electrical and electronic equipment, end users of electrical and electronic equipment should understand the meaning of the crossed-out wheeled bin symbol. Do not dispose of WEEE as unsorted municipal waste and have to collect such WEEE separately.

Revision

8/16-Port IP KVM Switch

Model: IKVM-8010 / IKVM-16010

Rev: 1.0 (March. 2011)

Part No. EM-IKVM-8010 / IKVM-16010

Table of Content

1	Introduction	6
1.1	Product Features	6
1.2	Package Contents	6
1.3	Product Specifications	7
1.4	Front Panels	8
1.5	Port LED Indications	8
1.6	7-seg BANK LED	8
1.7	Buttons and Operations	9
1.8	Back Panels	9
2	Hardware Installation	10
2.1	Desktop or Rack Mount	10
2.2	Computer/Server Installation	12
2.2.1	CAT5 KVM on Host Side	12
2.2.2	3-in-1 VGA Cable Installation	13
2.3	Console Installation	14
2.3.1	Local Console	14
2.4	Optional Remote Console Installation	14
2.4.1	CAT5 Transmitter Module	15
2.4.2	CAT5 KVM Receiver (R-Box)	15
2.5	Power Up Sequence	16
2.6	Daisy Chain Connection	17
3	Usage.....	19
3.1	Hotkey Commands and OSD Operations	19
3.2	DDC function	19
3.3	Hot Plug	19
3.4	Firmware Upgrade	20
4	Initial Configuration.....	21
4.1	Default Settings	21
4.2	Configuration via Setup Utility	21
4.3	Configuration via Serial Port	22
4.4	Keyboard, Mouse, and Video Configuration	23
4.4.1	Keyboard Settings	23
4.4.2	Remote Mouse Settings	24
4.4.3	Auto Mouse Speed and Mouse Synchronization	24
4.4.4	Host System Mouse Settings	24
4.4.5	Single and Double Mouse Mode	25
4.4.6	Recommended Mouse Settings	25

4.4.7	Video Modes	25
5	Remote Usage.....	26
5.1	Prerequisite	26
5.2	Login and Logout.....	27
5.2.1	Login.....	27
5.2.2	Logout	28
5.2.3	The Remote Console.....	29
5.2.4	Remote Console Control Bar	29
5.2.5	Remote Console Status Line	34
	Appendix A Cable Connectors Specifications	35
	Appendix B Troubleshooting & Frequently Asked Questions.....	36
	Appendix C Specifications	37

1 Introduction

With the innovative IP-based technology, PLANET has turned the traditional KVM switches into true networking devices. The IKVM-8010 / IKVM-16010 captures digitize and compresses video signal, then transmits it with keyboard and mouse signals through IP network. Multiple remote sites can monitor the same PC server simultaneously. With HTTPS/SSL authentication and data encryption, the IKVM-8010 / IKVM-16010 provide a non-intrusive solution for remote access and control. The remote access and control software operates on its embedded processors only, but not on mission-critical servers, so that there is no interference with server operation or decrease on the network performance.

The IKVM-8010 / IKVM-16010 will detect the current video mode of the console automatically; however, manual fine-tuning also available to receive an optimal video quality. The IKVM-8010 / IKVM-16010 will accept video streams with a dot clock rate up to 110MHz, therefore, the remote VGA resolution can up to 1600 x 1200 with a frame rate of 60 Hz.

Built-in 8/16-Port KVM switch, user can connect up to 8/16 PCs to IKVM-8010 / IKVM-16010. It can apply to the IP network and fully control the PCs of any platform through any at-hand browser or just work as a normal 8/16-Port KVM Switch in local. Supports daisy chain function, user can cascade two IKVM-8010 / IKVM-16010 to multiple KVM-800 or KVM-1600, and manage this KVM chain with single IP.

1.1 Product Features

19" rack mount 1U size design.

Remote mass storage control

LED Display for easy status monitoring

Keyboard status restored when switching PCs

Buzzer sound for switching port confirmation

Compliant with DOS, Windows, Netware, UNIX and Linux

Supports password protection and search PC server name

Built-in one extra daisy chain port to cascade with KVM-800 / 1600

No DIP switch setting needed and auto detect daisy chain bank

Automatically senses video resolution for best possible screen capture

Supports SSL protocol for any encrypted network traffic between itself and a connected client.

Supports Hot Plug function. Add or Remove PCs without power off the KVM switch or PCs.

High Video Quality – Resolution Up To 1920 x 1440 (local side), 1600 x 1200 (remote side)

No Software Required - easy PC selection via On Screen Display (OSD) menu, Push Buttons, Hot Keys

Compliant with iMAC, Power MAC and Sun Micro Systems with USB port (Need work with USB-PS/2 adapter)

1.2 Package Contents

Footpads x 4

CD-ROM x 1

Power Adapter x 1

IP KVM Switch Unit x 1

Rack Mount Kit x 1 set

DC2.5M to DB9F Cable x 1

1.3 Product Specifications

Supported Protocol	TCP, IP, ARP, ICMP, HTTP/HTTPS, Telnet, DHCP/BOOTP, PPP, SMTP, DNS, NTP, Dynamic DNS
Local Console Connectors (all female type)	USB keyboard port USB mouse port HDDDB 15-pin VGA port
Daisy Chain Connectors (all female type)	PS/2 keyboard port PS/2 mouse port HDDDB 15-pin VGA port
Remote Console	RJ-45 port
Host Connectors (all female type)	HDDDB 15-pin x 8
VGA Resolution	Local console: 1920 x 1440 Remote console: 1600 x 1200
Client Software	Microsoft Java VM, Sun Java VM (Plug in), Netscape Java VM

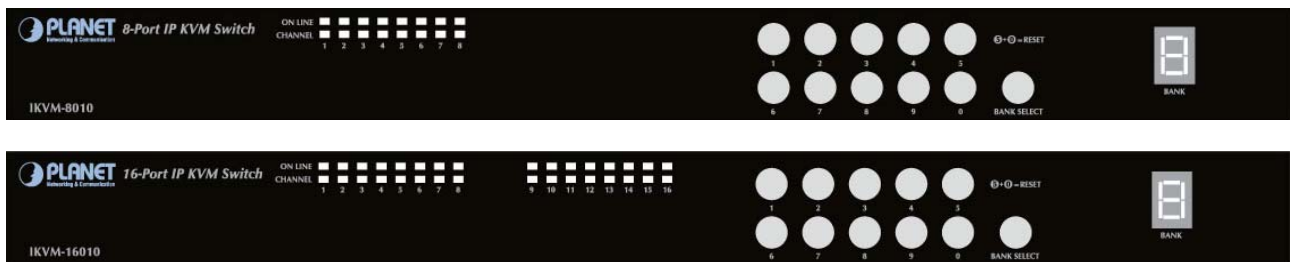

Front Panels of the Product Line

IKVM-8010 (8 ports combo VGA KVM switch with USB local console)



IKVM-16010 (16 ports combo VGA KVM switch with USB local console)

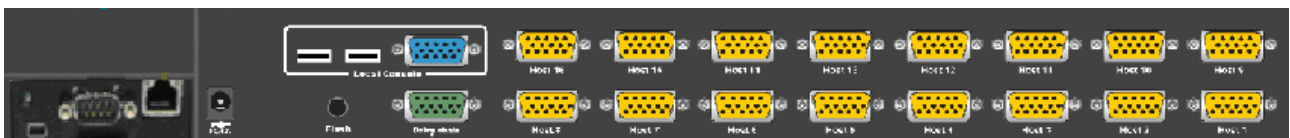

Back Panels of the Product line

1.4 Front Panels

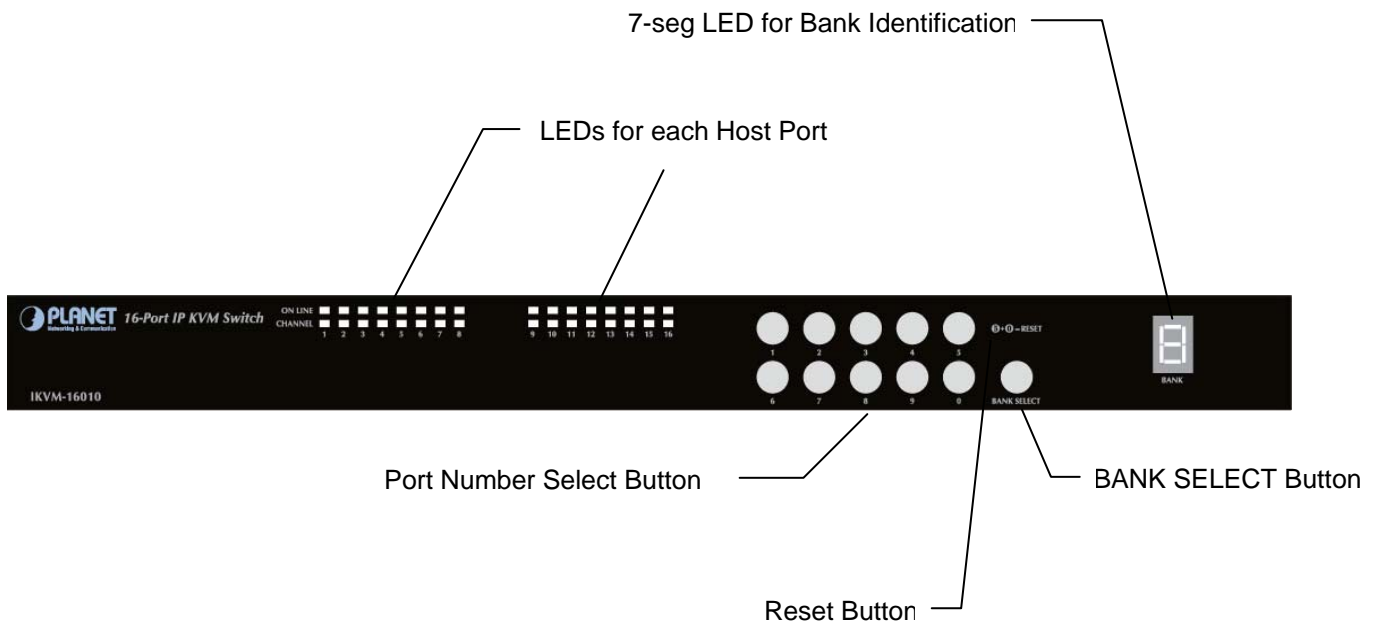

1.5 Port LED Indications

There are two LED's for each port:

- **ONLINE LED:** The Red LED on indicating a Computer is connecting to the port.
Notice: The PC99 Computer always power on the USB or PS/2 ports and turn on Red LED even if the Computer is not power on.
- **SELECT LED:** The Green LED on indicating the port has been selecting. The Green LED will be flashing if there is no Computer connected to the port.

1.6 7-seg BANK LED

The 7-segment BANK LED indicates the selected bank. Maximum 8 banks can be daisy chained.

In the daisy chain configuration, there are two methods to select the bank (KVM unit) you want to operate: Hotkey and OSD.

1.7 Buttons and Operations

There are 11 push buttons on the front panel. The operations described in below.

(1) The “BANK SELECT” is the Bank Select Button.

You can select to the required bank number by press the “BANK SELECT” button.

The current accessed bank will be displayed at the 7-Segment LED.

The bank select were from 1 to 8 and go back to 1 cycling. It will increase the bank number from the current selected bank to the next bank if you pressed the “BANK SELECT” button once.

(2) The “1”, “2”, “3”, “4”, “5”, “6”, “7”, “8”, “9”, “0” are the port number select buttons

You can select to the required port number by

- Press the 2 digit port number to switch the port directly. For example if you are in port 1 now, press “0” then “6” will switch to the port 6 immediately.
- Press the port number and wait for 2 seconds to switch the port. At this case, you can only press single digit to select to the destination if the port number is between port 1 to port 9.

(3) If you pressed the invalid operation, the system will stay at the previous selected port.

(4) RESET: Press the “5” and “0” button simultaneously will restart the firmware of the IP KVM switch.

1.8 Back Panels

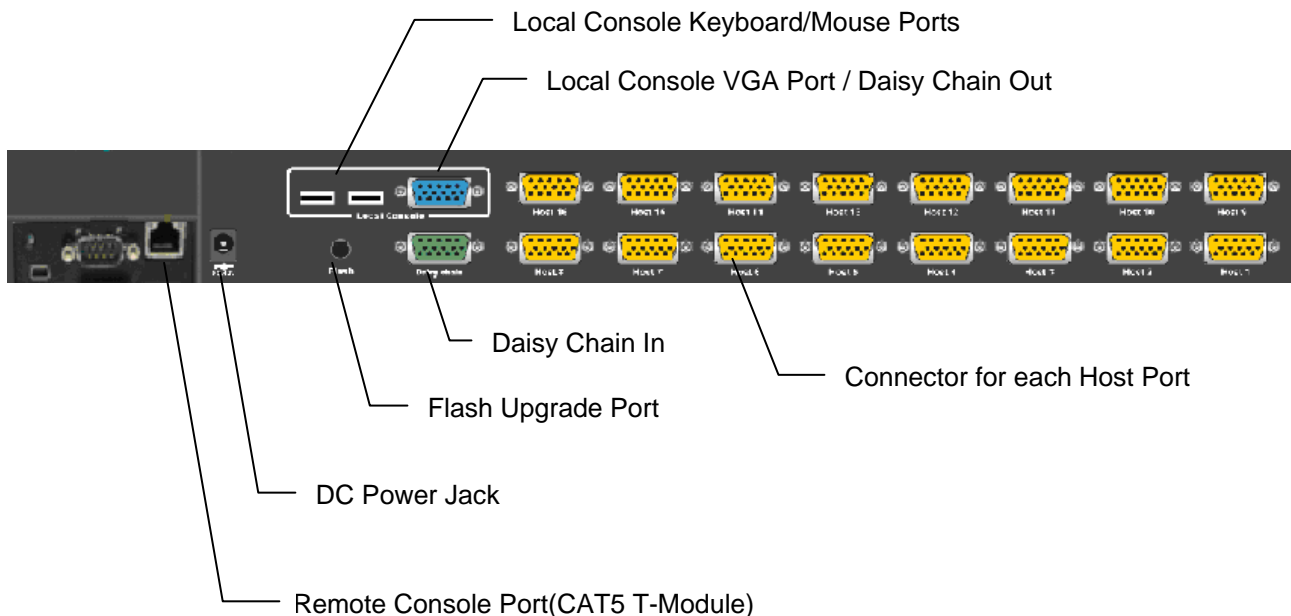

2 Hardware Installation

Before installation, please make sure all of peripherals and computers have been turned off.

2.1 Desktop or Rack Mount

The IKVM-8010 / IKVM-16010 switch unit can be placed on desktop or rack mounted.

Desktop

Stick the self-adhesive footpads that come with the package to the unit's bottom panel at the four corners. To install footpads, please turn upside down; and refer to the following instructions properly for installing the footpads.

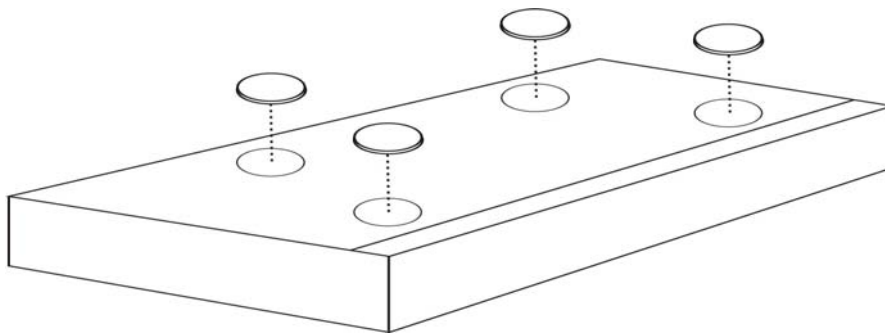

Footpads Installation

Rack Mounting

The IKVM-8010 / IKVM-16010 switch unit can be mounted on 19"/1U rack:

1. Screw the mounting brackets into the sides of the unit at the front, as shown in the diagram below. Take note of the length of your cables so that your computers, IKVM-8010/16010 Switch, keyboard, mouse and monitor are distanced properly.

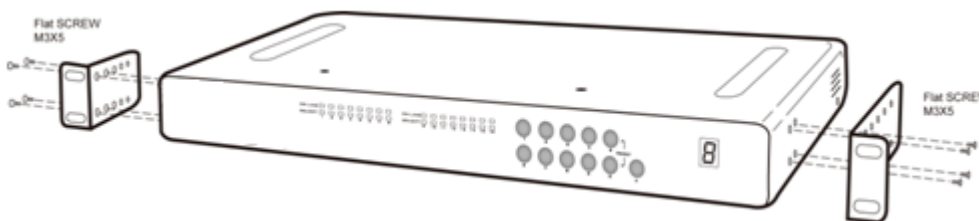

Rack Mount Installation -1

2. Slide the unit into the rack and secure it to the rack.

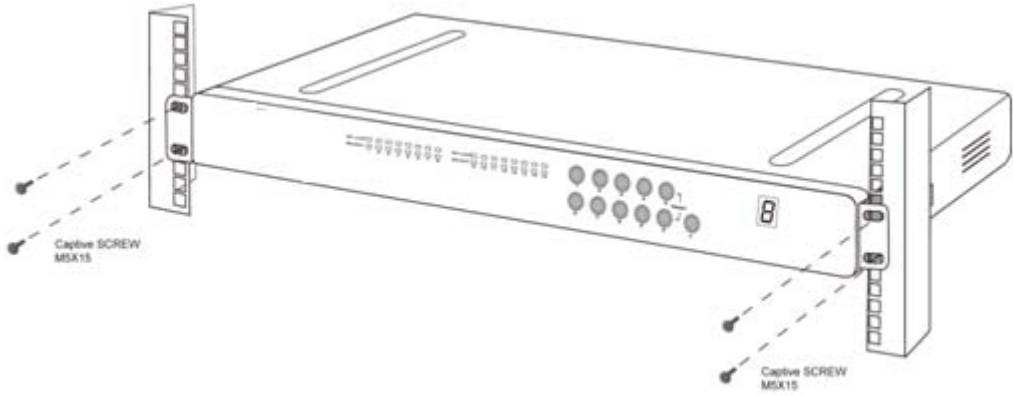

Rack Mount Installation -2

2.2 Computer/Server Installation

2.2.1 CAT5 KVM on Host Side

Please refer to the "CAT5 Extender User Manual" for details. The figure below depicts the computer/server installation.

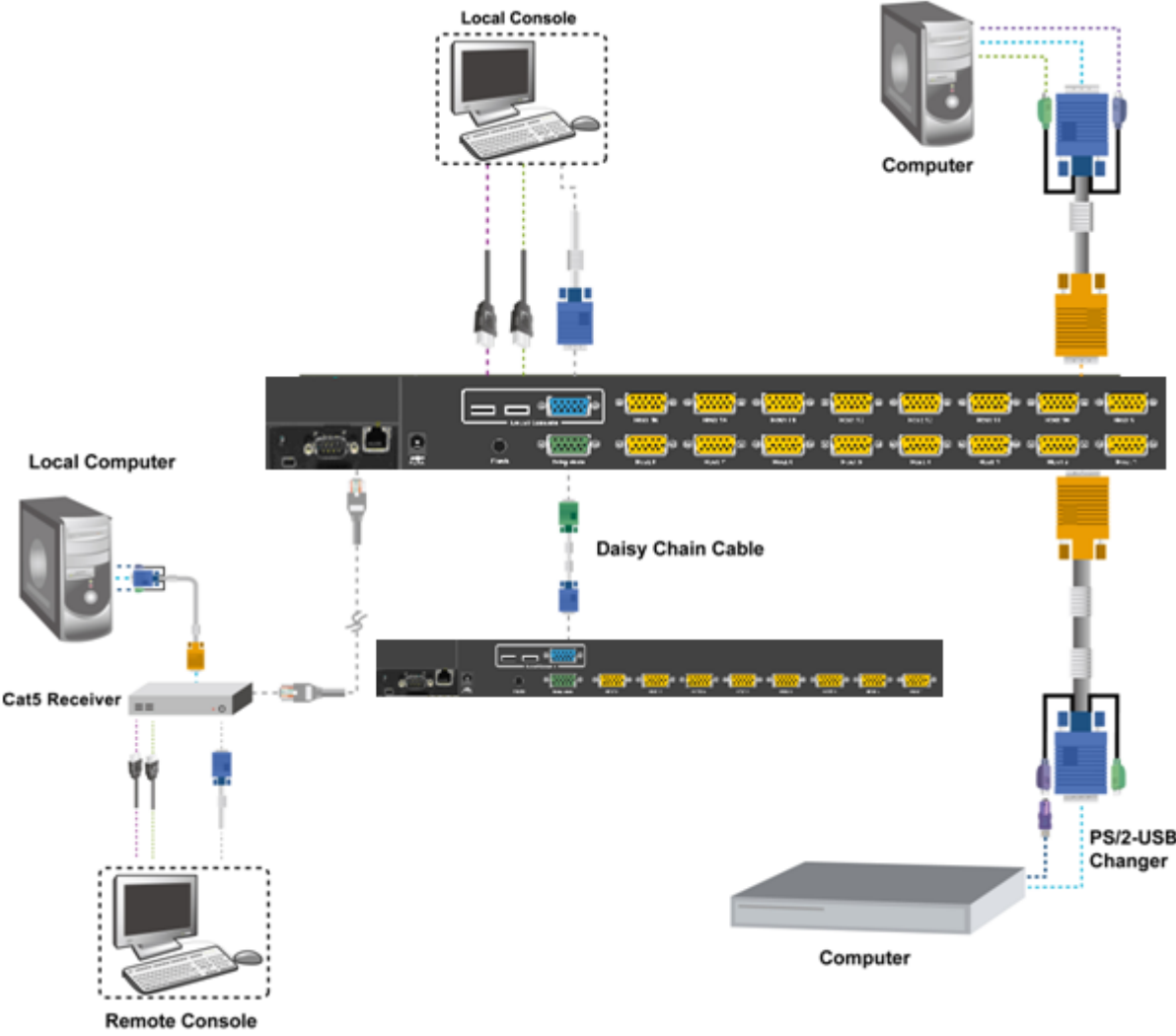

Computer/Server Installation

2.2.2 3-in-1 VGA Cable Installation

Each computer port connector is HDDB15 type. The 3-in-1 VGA cable has a HDDB15 male connector at one end. Plug it into computer port on the rear of KVM switch. The other end of input cable has three connectors: a HDDB15 male type for computer video, a purple mini din 6-pin PS/2 connector for keyboard and a green mini din 6-pin PS/2 connector for mouse. Plug these three connectors into the respective ports of computer. Repeat the same procedure for all other computers.

- (a) PS/2 computer --- Plug in PS/2 mouse connector to computer mouse port, the PS/2 keyboard connector to computer keyboard port. Do not hot plug PS/2 port. If you must do that make sure PS/2 mouse first then the PS/2 keyboard.



3-in-1 VGA cable

- (b) USB computer --- connect PS/2-USB changer to PS/2 keyboard connector, then plug the changer into available USB port. This single USB port can communicate both keyboard and mouse signals. It works as a standard HID (Human Interface Device), no extra driver needed.

PS/2-USB Changer



3-in-1 VGA Cable and PS/2 to USB Changer

Note:	It is recommended to power off all the computers and server before the installation. If we can not turn off the computer, for PS/2 computer, please plug in T-dongle connectors in the following order: firstly PS/2 mouse connector, secondly PS/2 keyboard connector, thirdly the VGA connector to the computer.
--------------	--

2.3 Console Installation

2.3.1 Local Console

Connect the monitor to the HDB15 female port on the back of the KVM unit labeled with the monitor symbol at the Local Console connector.

There may be USB local console or PS/2 local console. For USB local console, connect the USB keyboard to either one of USB local port and USB mouse to the other USB port. These USB ports are special designed for keyboard and mouse, and can not work with USB hub or other USB devices. For PS/2 local console, connect keyboard to purple PS/2 port and mouse to green PS/2 mouse port. There is a Daisy chain port under VGA ports.

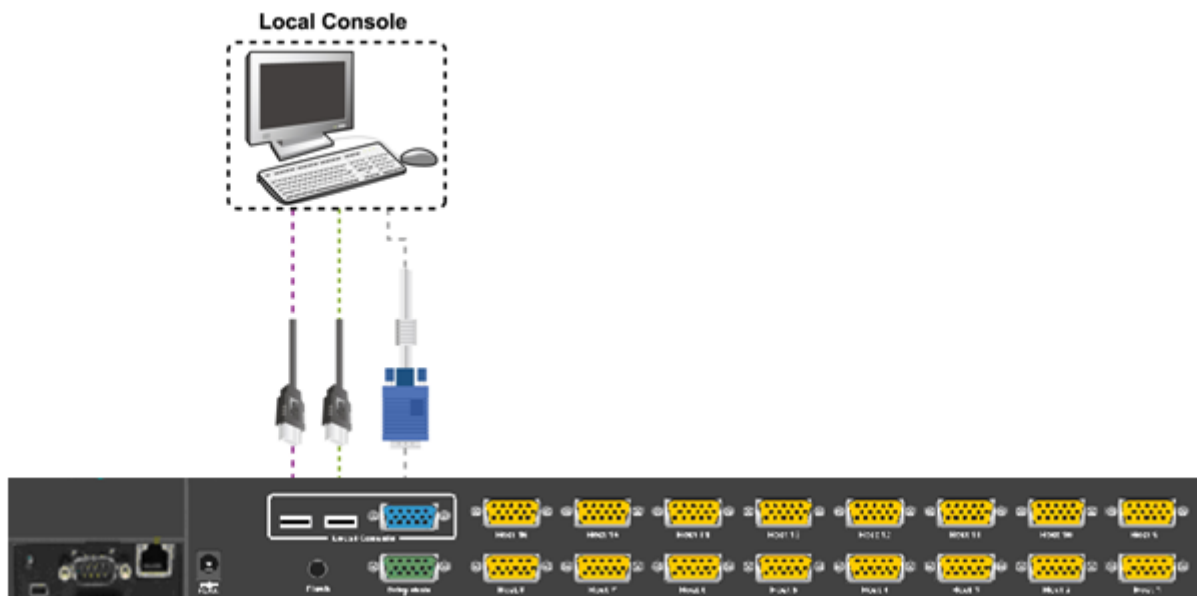

Local Console Installation

2.4 Optional Remote Console Installation

IP Module

Please refer to "IP KVM Module User Manual" for details.

IP Remote Console

Installation: Power off the KVM switch firstly. Remove the cover of the add-on slot, slide in the IP Module and make sure the module is fully inserted into the slot.

The IP Module redirects local keyboard, mouse and video data to a remote administration console. It allows you to control one or many computers locally at the server site or remotely via the Internet using a standard browser.

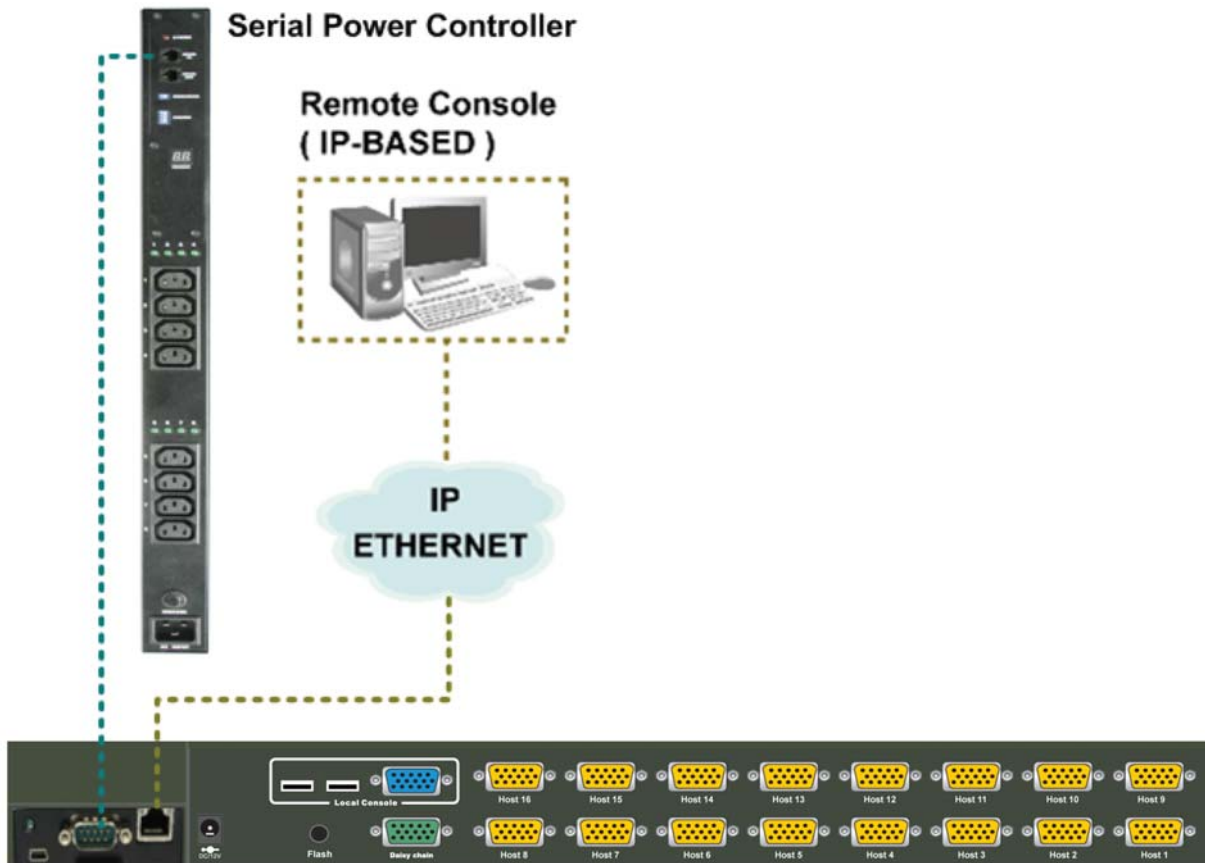

IP-Module

Serial Power Control

The IP Module comes with a serial port for connecting to any serial device, such as serial PDU (Power Distribution Unit) to provide remote power control, such as power on, power off, and power cycle for the connected computers/servers.

2.4.1 CAT5 Transmitter Module

CAT5 Remote Console

Installation: Power off the KVM switch firstly. Remove the cover of the add-on slot, slide in the CAT5 transmitter module and make sure the module is fully inserted into the slot.

To extending your console up to 1000 feet away by connecting the CAT5 cable to the R-Box in the remote end.

Please refer to the "CAT5 Extender User Manual" for details.

2.4.2 CAT5 KVM Receiver (R-Box)

Please refer to the "CAT5 Extender User Manual" for details.

2.5 Power Up Sequence

Double check whether all cables/connectors are properly connected. You can check the color of keyboard and mouse connectors to ensure the connectors and cables are connected correctly.

The recommended Power Up sequence is as follows: Monitor, KVM Switch, finally the Computers.

Verify that all servers connected to the KVM Switch are powered on. If any connected servers have not been powered on, it is okay to do so at this time (servers can be powered on simultaneously). The KVM Switch emulates both a mouse and keyboard on each port and allows your server to boot normally.

When power on the KVM switch, you will see the SELECT LED of Port 1 lights up, and hear a beep sound. If you encounter an error, check your cable connections for that server and reboot. If the problem persists, please refer to the chapter “Troubleshooting” in this User Manual.

2.6 Daisy Chain Connection

Use one end of daisy chain cable to connect to the **Daisy Chain** port of Master KVM switch and connect the other end of daisy chain cable to the **Local Console** port of the next Slave KVM switch. Please repeat the connection procedures for next Slave KVM switch. You can daisy chain up to eight banks in maximum.

Note:	The Daisy Chain cable is 15 lines fully connected. This is a special VGA cable, normal VGA cable have unconnected lines.
--------------	--

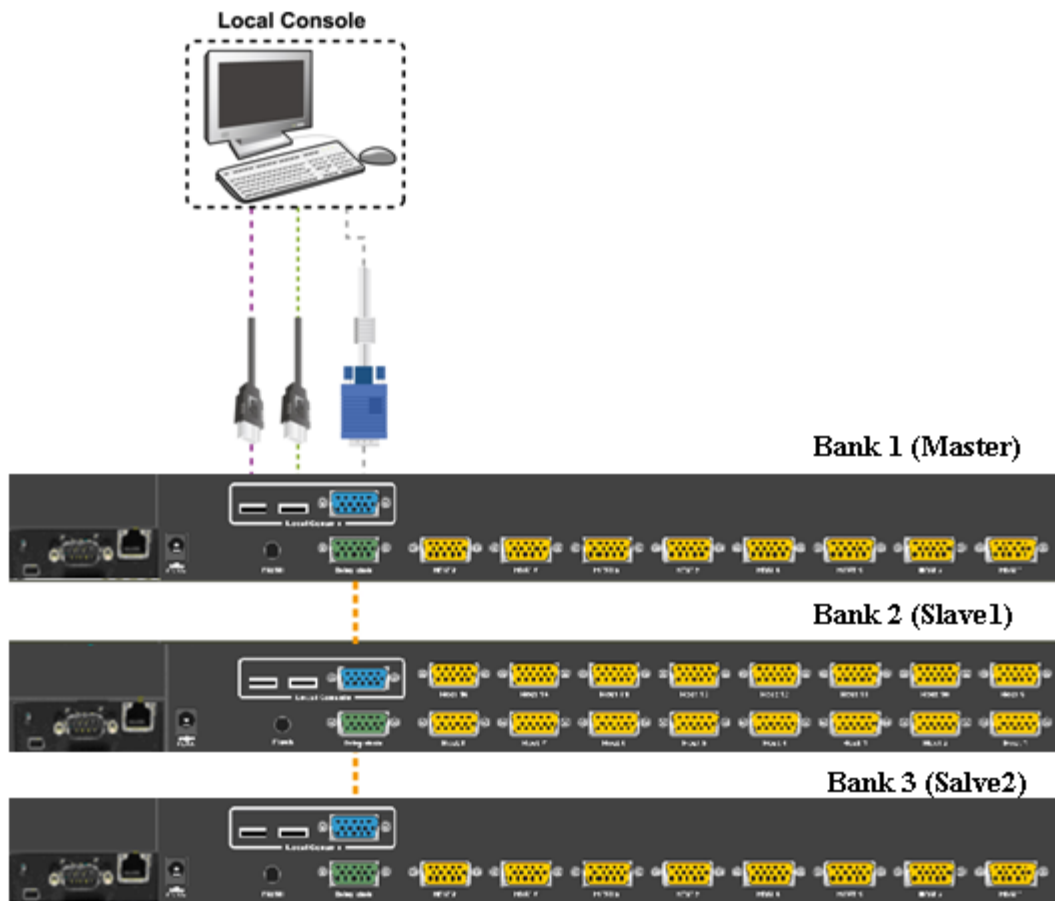

Daisy Chain Connection

The console OSD menu will show only the port information of the master KVM switch. When the master unit starts up, it will query all daisy chained Slave units, and automatically set up the Bank ID for each Slave unit. So the 7-seg LED on the Master unit will display 1, Slave 1 will display 2, Slave 2 will display 3, and so on. If not so, please reset the Master unit to update the Bank ID immediately. Hot Plug function is supported in daisy chain connection.

You can also daisy chain through computer port. This daisy chain can work with other brand of KVM switch, but you need to change the Hotkey of slave KVM switches so that the master and slave KVM switches do not use the same Hotkey.

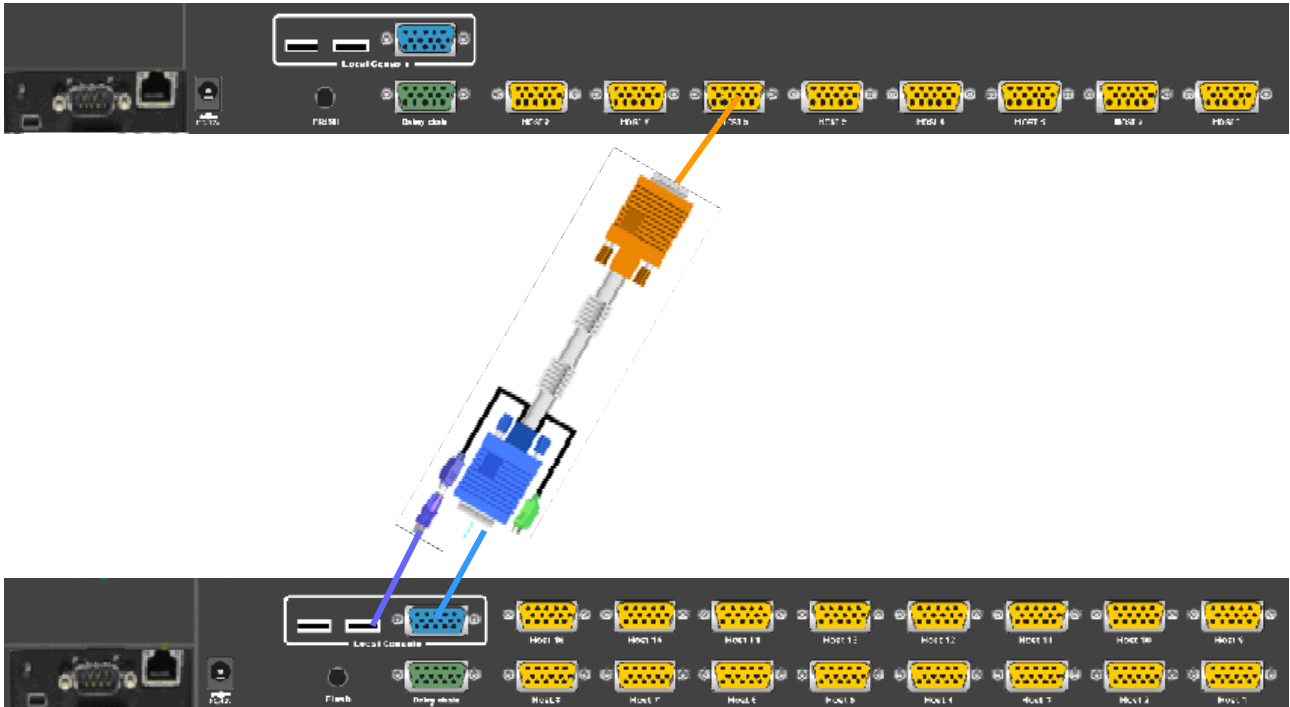

Daisy Chain through Computer Port

3 Usage

Now that you have connected your console and servers to your KVM Switch, it is ready for use.

You can control the KVM switch by three methods:

1. Using push buttons located on the front panel of the KVM Switch
2. Through the OSD (On-Screen Display)
3. Using hot-key commands through the console keyboard

It takes approximately 1-2 seconds for the video signal to refresh after switching servers. Re-synchronization of the mouse and keyboard signals also occurs. This is normal operation and ensures that proper synchronization is established between the console and the connected servers.

When you power on KVM switch, if the security function is enabled (default is disabled), it will prompt a Login window waiting for user name and password. You need to pass the authentication so can control the KVM switch.

3.1 Hotkey Commands and OSD Operations

Please refer to “Hotkey and OSD User Manual” for details.

3.2 DDC function

The KVM Switch support DDC (Display Data Channel). DDC is a VESA standard for communication between a monitor and a video adapter. Using DDC, a monitor can inform the video card about its properties, such as maximum resolution and color depth. The video card can then use this information to ensure that the computer is presented with valid options for configuring the display.

Note:	The DDC function of KVM Switch will dynamically detect and copy the DDC data from the monitor that attached to the LOCAL console port , and that data will feed to the host computer during computer startup.
--------------	--

3.3 Hot Plug

The KVM Switch supports “Hot Plug” function for USB keyboard and mouse connectors.

Note:	Normally, PS/2 port is not Hot pluggable. Normally, USB port is Hot pluggable, but some OS (Operation Systems), like Sun Micro and some Unix and Linux, do not support USB Hot Plug function. If you apply Hot Plug to this kind of OS, it will cause unpredictable behavior or shut down the Computer. Before attempting to use Hot Plug, please make sure OS and mouse software driver support the Hot Plug function
--------------	--

3.4 Firmware Upgrade

Please follow the following procedures:

1. Power off the KVM switch.
2. Prepare the DC2.5M/DB9F cable, plug the DC2.5 end to the KVM switch's phone jack (marked Flash) and the DB9F end to PC serial DB9 port.
3. Power on the KVM unit. The KVM unit now will be in Flash mode, waiting for firmware download.
4. Run "Firmware Upgrade Utility.exe"

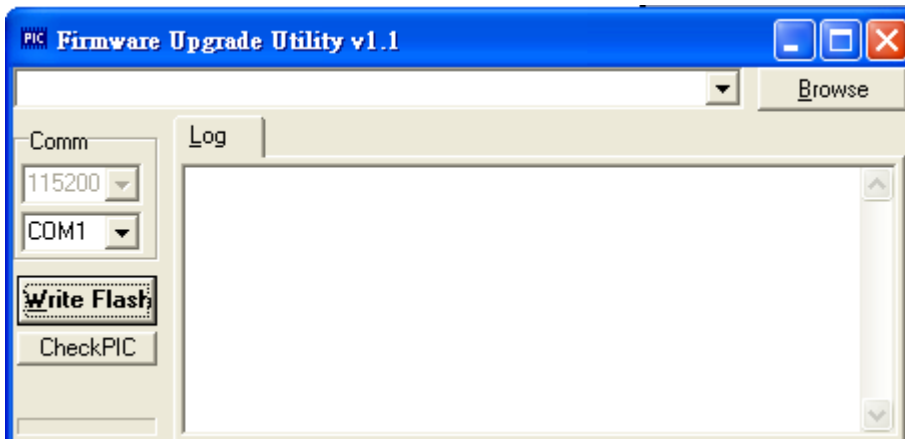

5. Click **Browse** to select the FW upgrade file. Please make sure you select the **correct FW upgrade file**.
6. Click **Write Flash** to start to upgrade. The upgrade process takes about 6 seconds, then display **WRITE OK** if complete the upgrade successfully.

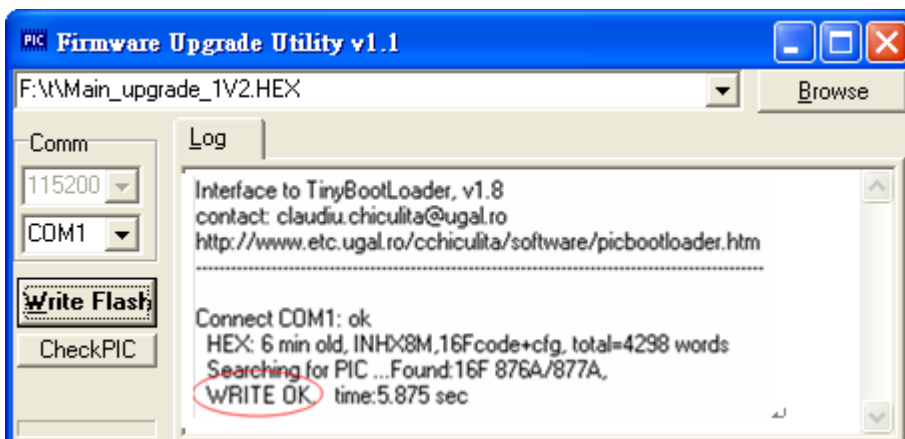

7. Disconnect the DC2.5M/DB9F cable from the KVM unit and PC. Now the KVM unit should be running on the new firmware. The FW version can be seen on the bottom-right corner of the PORT NAME OSD window.

4 Initial Configuration

4.1 Default Settings

The communication interfaces of IKVM-8010 / IKVM-16010 are all based on TCP/IP. It comes with the default settings as below.

Parameter	Value
IP-Address	192.168.1.1 (disabled)
Net-mask	255.255.255.0
Default-Gateway	none
Super user name	super
Super user password	pass

4.2 Configuration via Setup Utility

By default, the IKVM-8010 / IKVM-16010 will obtain its IP address from a DHCP server in the network. If a DHCP server is found, it may provide a valid IP address, gateway address and net mask. Before you connect IKVM-8010 / IKVM-16010 to your local network, please make sure the corresponding configuration of your DHCP server is completed. It is recommended to reserve a fixed IP assignment to the MAC address of the IKVM-8010 /16010. You can find the MAC address labeled on the bottom side of the metal housing.

If this initial configuration does not meet your local requirements, use the setup tool to adjust the values to your needs. The setup tool can be found on the CD-ROM delivered with this package. You can follow the procedure described below.

1. Connect the IKVM-8010 / IKVM-16010 to the same network as your administrative PC, or you can use an USB cable (type A to type B) to connect administrative PC and IKVM-8010 / IKVM-16010 directly. The USB connectivity only supported in windows 2000/XP/Win7 and server 2003 and the response time of USB connection would be longer than LAN connection.
2. Insert the bundled CD-ROM into the CD-ROM drive to initiate the auto run program. Click on "Setup Utility" hyperlink in the menu screen to execute the program.
If the menu screen is not shown, you can click "Start" button and choose "Run...". When the dialog box appears, enter "E:\utility\psetup.exe" (suppose "E" is your CD-ROM drive) and click "OK".
3. Once the utility is executed, it will search for available IKVM-8010 / IKVM-16010 automatically.

4. On the upper left corner, the MAC addresses of the IKVM-8010 / IKVM-16010 are displayed. To manually detect the MAC address again, press the button “Refresh Devices”. The displayed MAC address is the same MAC address printed on the sticker placed on the bottom of the IKVM-8010 /16010. If the IKVM-8010 / IKVM-16010 are connected via USB, it is classified as an USB device and an appropriate drive letter is chosen for this device.
5. On the lower right corner of the window, there are two buttons: “Query Device” and “Setup Device”. Press the “Query Device” button to display the preconfigured values of the network configuration. The values are displayed in the text fields located above. If necessary, adjust the network settings according to your requirement. To save the changes, enter “**super**” in the “Super user login” field and “**pass**” in the “Super user password” field. Then press the “Setup Device” button.
6. On the lower left Authentication field, you can change the super user password here. However, the super user name is fixed to “**super**” and can’t be modified. The default super user password is “**pass**”. It is recommended to change the super user password as soon as you get this device.

The Wireless LAN Configuration field is left for future enhancement.

4.3 Configuration via Serial Port

Using a serial terminal, the IKVM-8010 / IKVM-16010 have a serial line interface (host side). This connector is compliant with the RS-232 serial line standard. The serial line has to be configured with the parameters given as below.

Parameter	Value
Bits/second	115200
Data bits	8
Parity	No
Stop bits	1
Flow Control	None

When configuring with a serial terminal, press the reset button of IKVM-8010 / IKVM-16010 and immediately press the “ ESC ” key on the keyboard of administrative PC. You will see some device information, and a “ => ” prompt. There are four commands available.

config: start configuration tool after boot up

defaults: set the device settings to factory defaults

help: print online help

reset: perform a soft reset

When using “config” command, the following interactive options will appear:

IP auto configuration (non/dhcp/bootp) [dhcp]:

With this option, you can specify whether the IKVM-8010 / IKVM-16010 should get its network settings from a DHCP or BOOTP server. For DHCP, enter “dhcp”, and for BOOTP enter “bootp”. If you do not specify any of these, the IP auto configuration is disabled and subsequently you will be asked for the following network settings.

IP [192.168.1.1]:

This is the current IP address of the IKVM-8010 / IKVM-16010. This option is only available if IP auto configuration is disabled.

Net mask [255.255.255.0]:

This is the net mask of the connected IP subnet. This option is only available if IP auto configuration is disabled.

Gateway (0.0.0.0 for none) [0.0.0.0]:

This is the IP address of the default router for the connected IP subnet. If you do not have a default router, enter 0.0.0.0. This option is only available if IP auto configuration is disabled.

4.4 Keyboard, Mouse, and Video Configuration

Between the IKVM-8010 / IKVM-16010 and the host, there are two interfaces available for transmitting keyboard and mouse signals: USB and PS/2. The correct operation of the remote mouse depends on several settings, which will be discussed in the following subsections.

4.4.1 Keyboard Settings

The IKVM-8010 / IKVM-16010 settings for the host's keyboard type must be corrected in order to make the

remote keyboard work properly. See Section 5.4.2 in details.

4.4.2 Remote Mouse Settings

A common issue with KVM devices is the synchronization between the local and remote mouse cursors. The IKVM-8010 / IKVM-16010 address this situation with an intelligent synchronization algorithm. There are two mouse modes available on the IKVM-8010 / IKVM-16010.

Auto mouse speed

The automatic mouse speed mode tries to detect the speed and acceleration settings of the host system automatically. See the section below for a more detailed explanation.

Fixed mouse speed

This mode just translates the mouse movements from the Remote Console in a way that one pixel move will lead to n pixel moves on the remote system. This parameter n is adjustable with the scaling. It should be noted that this works only when mouse acceleration is turned off on the remote system.

4.4.3 Auto Mouse Speed and Mouse Synchronization

The automatic mouse speed mode performs the speed detection during mouse synchronization. Whenever the mouse does not move correctly, there are two ways for re-synchronizing local and remote mouse:

Fast Sync

The fast synchronization is used to correct a temporary, but fixed skew. Choose the option using the Remote Console options menu or press the mouse synchronization hotkey sequence if you already defined one.

Intelligent Sync

If the fast sync does not work or the mouse settings have been changed on the host system, use the intelligent resynchronization. This method takes more time than Fast Sync and can be accessed with the appropriate item in the Remote Console option menu. The intelligent synchronization requires a correctly adjusted picture. Use the auto adjustment function or the manual correction in the Video Settings panel to setup the picture. The Sync mouse button on top of the Remote Console may behave differently, depending on the current state of mouse synchronization. Usually pressing this button leads to a fast sync, except in situations where the KVM port or the video mode changed recently.

Note:

At first start, if the local mouse pointer is not synchronized with the remote mouse pointer, press the Auto Adjust Button once.

4.4.4 Host System Mouse Settings

While the IKVM-8010 / IKVM-16010 works with accelerated mice and are able to synchronize the local with the remote mouse pointer, there are the following limitations, which may prevent this synchronization from working properly: (the following limitations do not apply in case of USB and Mouse Type "MS Windows 2000 and newer".)

Special Mouse Driver

There are mouse drivers that influence the synchronization process and lead to desynchronized mouse pointers. If this happens, make sure you do not use a special vendor-specific mouse driver on your host system.

Windows XP Mouse Settings

Windows XP knows a setting named "improve mouse acceleration", which has to be deactivated.

Active Desktop

If the Active Desktop feature of Microsoft Windows is enabled, do not use a plain background. Instead, use some kind of wallpaper. As an alternative, you could also disable the Active Desktop completely.

Navigate your mouse pointer into the upper left corner of the applet screen and move it slightly forth and back. Thus the mouse will be resynchronized. If re-synchronizing fails, disable the mouse acceleration and repeat the procedure.

4.4.5 Single and Double Mouse Mode

The information above applies to the Double Mouse Mode, where remote and local mouse pointers are visible and need to be synchronized. The IKVM-8010 / IKVM-16010 also feature another mode, the Single Mouse Mode, where only the remote mouse pointer is visible. Activate this mode in the open Remote Console and click into the window area. The local mouse pointer will be hidden and the remote one can be controlled directly. To leave this mode, it is necessary to define a mouse hotkey in the Remote Console Settings Panel. Press this hotkey to free the captured local mouse pointer.

4.4.6 Recommended Mouse Settings

For the different operating systems we can give the following advice:

MS Windows 2000/XP/2003/Win7 (Professional and Server)

In general, we recommend the usage of a mouse via USB. Choose USB without Mouse Sync. For a PS/2 mouse, choose Auto Mouse Speed. For XP disable the option enhances pointer precision in the Control Panel.

SUN Solaris

Adjust the mouse settings either via `xset m 1` or use the CDE Control Panel to set the mouse to 1:1, no acceleration. As an alternative you may also use the Single Mouse Mode.

MAC OS X

We recommend using the Single Mouse Mode.

4.4.7 Video Modes

The IKVM-8010 / IKVM-16010 recognize a limited number of common video modes. When running X11 on the host system, please do not use any custom mode lines with special video modes. If you do, the IKVM-8010 /16010 may not be able to detect them. We recommend using any of the standard VESA video modes, instead.

5 Remote Usage

5.1 Prerequisite

The IKVM-8010 / IKVM-16010 feature an embedded operating system and applications offering a variety of standardized interfaces. This chapter will describe both these interfaces, and the way to use them in a more detailed manner. The interfaces are accessed using the TCP/IP protocol family, thus they can be accessed using the built-in Ethernet port.

The following interfaces are supported:

HTTP/HTTPS

The IKVM-8010 / IKVM-16010 can be entirely managed using a standard web browser. You can access the IKVM-8010 /16010 using the insecure HTTP protocol, or using the encrypted HTTPS protocol. Whenever possible, use HTTPS.

Telnet

A standard Telnet client can be used to access an arbitrary device connected to the IKVM-8010 / IKVM-16010 port via a terminal mode.

The primary interface of the IKVM-8010 / IKVM-16010 is the HTTP interface. This is covered extensively in this chapter. Other interfaces are addressed in subtopics.

In order to use the Remote Console window of your managed host system, the browser has to come with a Java Runtime Environment version 1.1 or higher. If the browser has no Java support (such as on a small handheld device), you are still able to maintain your remote host system using the administration forms displayed by the browser itself.

Important: We recommend installing a Sun JVM 1.4.

For an insecure connection to the IKVM-8010 / IKVM-16010, we can recommend the following browsers:

- Microsoft Internet Explorer version 6.0 or higher on Windows 98, Windows ME, Windows 2000, Windows XP, Windows Server 2003 and Win7.
- Netscape Navigator 7.0 or Mozilla 1.6 on Windows 98, Windows ME, Windows 2000, Windows XP, Windows Server 2003, Win7 and Linux and other UNIX-like Operating Systems

In order to access the remote host system using a securely encrypted connection, you need a browser that supports the HTTPS protocol. Strong security is only assured by using a key length of 128 Bit. Some of the old browsers do not have a strong 128 Bit encryption algorithm.

Using the Internet Explorer, open the menu entry “?” and “Info” to read about the key length that is currently activated. The dialog box contains a link that leads you to information on how to upgrade your browser to a state of the art encryption scheme. The picture below shows the dialog box presented by the Internet Explorer 6.0.



Newer web browsers do support strong encryption on default.

5.2 Login and Logout

5.2.1 Login

Note: Your web browser has to accept cookies, or else login is not possible.

Launch your web browser. Direct it to the address of your IKVM-8010 / IKVM-16010, which you configured during the initial configuration. The address used might be a plain IP address or a host and domain name, in the case where you have given your IKVM-8010 / IKVM-16010 a symbolic name in the DNS. For instance, type the following in the address line of your browser when establishing an unsecured connection:

http://<IP address of IKVM-8010 / IKVM-16010 >

When using a secure connection, type in:

https://<IP address of IKVM-8010 / IKVM-16010>

This will lead you to the IKVM-8010 / IKVM-16010 login page.

The IKVM-8010 / IKVM-16010 have a built-in super user that has all permissions to administrate the device:

Login name	super (in default)
Password	pass (in default)

Warning: The user “super” is not allowed to login via the serial interface of the IKVM-8010 / IKVM-16010.

Note: Please change the super user password immediately after the first time login successfully. Not changing the pass phrase for the super user is a severe security risk and might result in unauthorized access to the IKVM-8010 / IKVM-16010 and to the host system including all possible consequences!

Having logged into the IKVM-8010 / IKVM-16010 successfully, the main page of the IKVM-8010 / IKVM-16010 will appear.



This page consists of three parts; each of them contains specific information. The buttons on the upper side allow you to navigate within the front end.



Return to the main page of the IKVM-8010 / IKVM-16010 .



Open the IKVM-8010 / IKVM-16010 remote console.



Exit from the IKVM-8010 / IKVM-16010 front end.

The lower left frame contains a navigation bar and allows you to switch between the different sections of the IKVM-8010 / IKVM-16010. Within the right frame, task-specific information is displayed that depends on the section you have chosen before.

Warning: If there is no activity for half an hour, the IKVM-8010 /16010 will log you out, automatically. A click on one of the links will bring you back to the login screen.

5.2.2 Logout



This button logs out the current user and presents a new login screen. Please note that an automatic logout will be performed in case there is no activity for half an hour.

5.2.3 The Remote Console



Clicking on the icon opens an additional Remote Console window. The Remote Console window is a Java Applet that tries to establish its own TCP connection to the IKVM-8010 /16010. The protocol that is run over this connection is neither HTTP nor HTTPS, but RFB (Remote Frame Buffer Protocol). Currently, RFB tries to establish a connection to port number 443. Your local network environment has to allow this connection to be made, i.e. your firewall end, in case you have a private internal network, your NAT (Network Address Translation) settings have to be configured accordingly.

In case the IKVM-8010 /16010 are connected to your local network environment and your connection to the Internet is available using a proxy server only without NAT being configured, the Remote Console is very unlikely to be able to establish the according connection. This is because today's web proxies are not capable of relaying the RFB protocol.

In case of problems, please consult your network administrator in order to provide an appropriate network environment.

Once the Remote Console is connected, it displays the screen content of your host system. The Remote Console will behave exactly in the same way as if you were sitting directly in front of the screen of your remote system. That means keyboard and mouse can be used in the usual way. However, be aware of the fact that the remote system will react to keyboard and mouse actions with a slight delay. The delay depends on the bandwidth of the network which you use to connect to the IKVM-8010 / IKVM-16010.

With respect to the keyboard, the very exact remote representation might lead to some confusion as your local keyboard changes its keyboard layout according to the remote host system. If you use a German administration system, and your host system uses a US English keyboard layout, for instance, special keys on the German keyboard will not work as expected. Instead, the keys will result in their US English counterpart. You can circumvent such problems by adjusting the keyboard of your remote system to the same mapping as your local one.

The Remote Console window always tries to show the remote screen with its optimal size. That means it will adapt its size to the size of the remote screen initially and after the screen resolution of the remote screen has been changed. However, you can always resize the Remote Console window in your local window system as usual.

5.2.4 Remote Console Control Bar

The upper part of the Remote Console window contains a control bar. Using its elements you can see the state of the Remote Console and influence the local Remote Console settings. A description for each control follows.

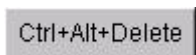
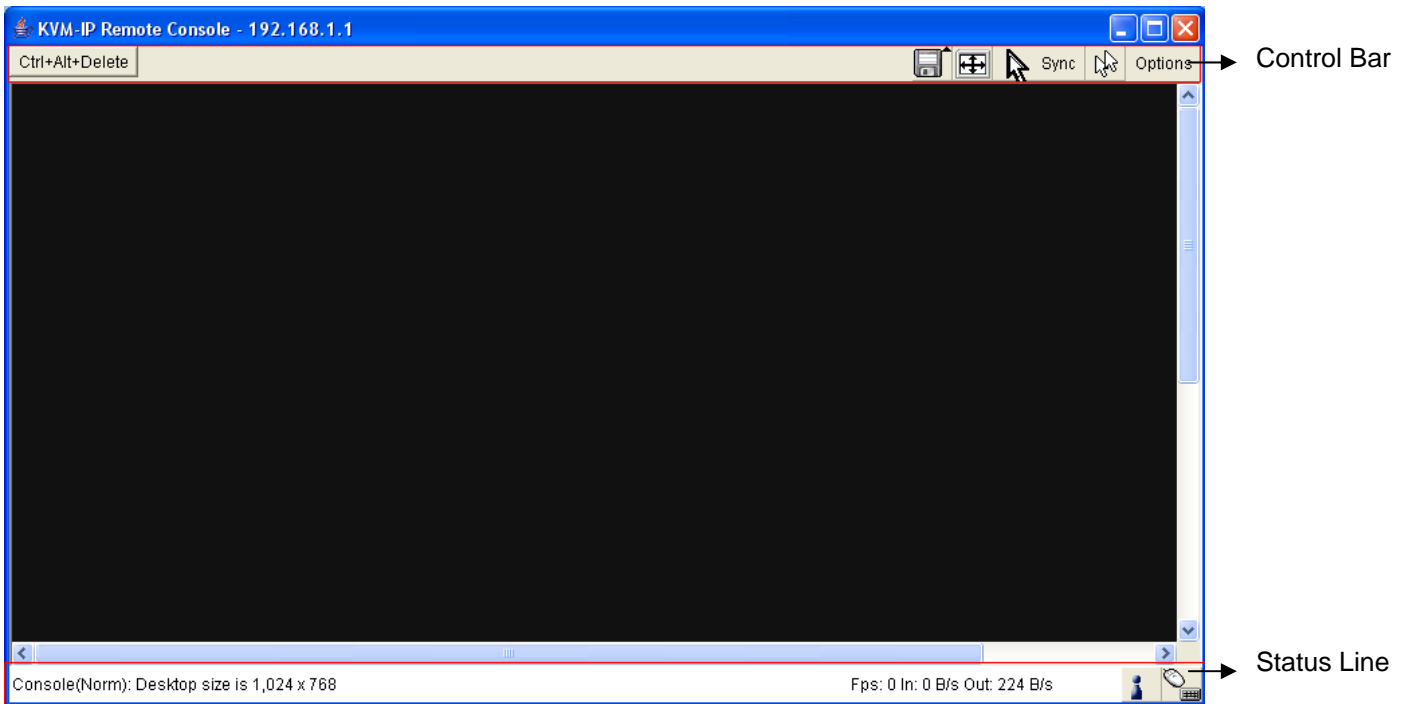

Special button to send the “Control+Alt+Delete” key combination to the remote system.



Auto Adjust Button

If the video display is of bad quality or distorted in some way, press this button and wait a few seconds while the IKVM-8010 / IKVM-16010 tries to adjust itself for the best possible video quality.

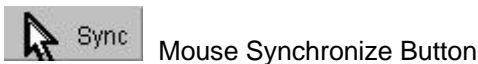

Mouse Synchronize Button

Pressing this button to activate the mouse synchronization process. Choose this option in order to synchronize the local with the remote mouse cursor. This is especially necessary when using accelerated mouse settings on the host system. In general, there is no need to change mouse settings on the host.



Single/Double Mouse Mode

Switches between the Single Mouse Mode (where only the remote mouse pointer is visible) and the Double Mouse Mode (where remote and local mouse pointers are visible and need to be synchronized). Single mouse mode is only available if using SUN JVM 1.3 or higher.

Options

Click on this button, an Options menu will appear:

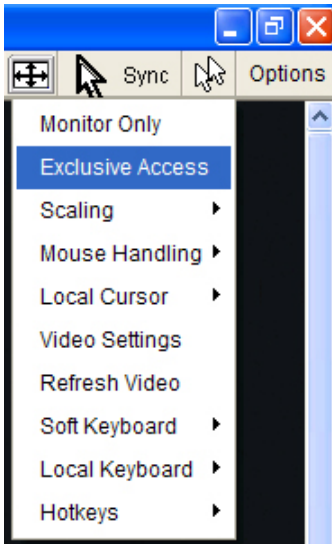

A short description of the options follows.

- **Monitor Only**

Toggles the Monitor only filter on or off. If the filter is switched on, no remote console interaction is possible, and monitoring is possible.

- **Exclusive Access**

If a user has the appropriate permission, he can force the Remote Consoles of all other users to close. No one can open the Remote Console at the same time again until this user disables the exclusive access, or logs off.

A change in the access mode is also visible in the status line.



- **Scaling**

Allow you to scale down the Remote Console. You can still use both mouse and keyboard, however the scaling algorithm will not preserve all display details.

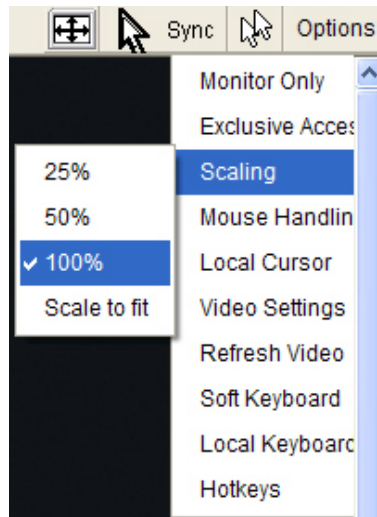

• Mouse Handling

The submenu for mouse handling offers two options for synchronizing the local and the remote mouse pointer.

Fast Sync--The fast synchronization is used to correct a temporary, but fixed skew.

Intelligent Sync--Use this option if the fast sync does not work or the mouse settings have been changed on the host system.

This method takes more time than the fast one and requires a correctly adjusted picture. Use the auto adjustment function or the manual correction in the Video Settings panel to setup the picture.

• Local Cursor

Offers a list of different cursor shapes to choose from for the local mouse pointer. The selected shape will be saved for the current user and activated the next time this user opens the Remote Console. The number of available shapes depends on the Java Virtual Machine; a version of 1.2 or higher offers the full list.

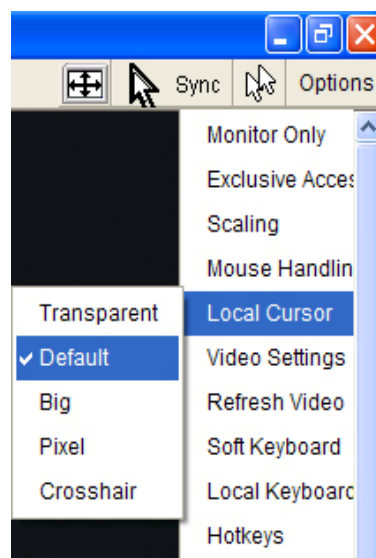

• Video Settings

Opens a panel for changing the IKVM-8010 / IKVM-16010 video settings.

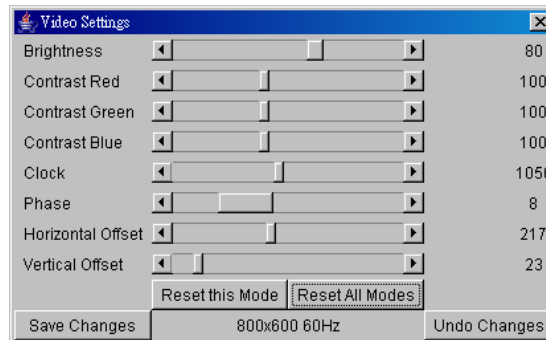

Brightness--Controls the brightness of the picture.

Contrast--Controls the contrast of the picture.

Clock--Defines the horizontal frequency for a video line and depends on the video mode. Different video card types may require different values here. The default settings in conjunction with the auto adjustment procedure should be adequate for all common configurations. If the picture quality is still bad after auto adjustment, you may try to change this setting together with the sampling phase to achieve a better quality.

Phase--Defines the phase for video sampling, used to control the display quality together with the setting for sampling clock.

Horizontal Position--Use the left and right buttons to move the picture in horizontal direction while this option is selected.

Vertical Position--Use the left and right buttons to move the picture in vertical direction while this option is selected.

Reset this Mode--Reset mode specific settings to the factory-made defaults.

Reset all Modes--Reset all settings to the factory-made defaults.

Save Changes--Save changes permanently.

Undo Changes--Restore last settings.

• Soft Keyboard



Opens up the Menu for the Soft-Keyboard.

Show--Pops up the Soft-Keyboard. The Soft-Keyboard is necessary in case your host system runs a completely different language and country mapping than your administration machine.

Mapping--Used for choosing the according language and country mapping of the Soft-Keyboard.

• Local Keyboard

Used to change the language mapping of your browser machine running the Remote Console Applet. Normally, the applet determines the correct value automatically. However, depending on your particular JVM and your browser settings this is not always possible. A typical example is a German localized system that uses an US-English keyboard mapping. In this case you have to change the Local Keyboard setting to the right language, manually.

• Hotkeys

Opens a list of hotkeys defined previously. Choose one entry, the command will be sent to the host system.

A confirmation dialog can be added that will be displayed before sending the selected command to the remote host. Select "OK" to perform the command on the remote host.

5.2.5 Remote Console Status Line

The Remote Console Status Bar shows both console and the connection state. The size of the remote screen is displayed. The value in brackets describes the connection to the Remote Console. "Norm" means a standard connection without encryption, "SSL" indicates a secure connection.

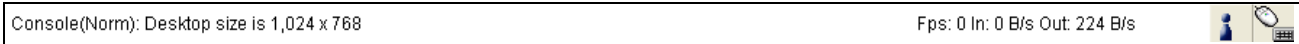

Furthermore, both the incoming ("In:") and the outgoing ("Out:") network traffic are visible (in B/s). If compressed encoding is enabled, a value in brackets displays the compressed transfer rate.

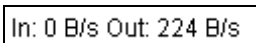

Appendix A Cable Connectors Specifications

Cable Connectors

1. 3-in-1 VGA Cable

HDDDB15 male to one HDDDB15 male plus two minis din 6-pin PS/2 connectors.



3-in-1 VGA Cable Connectors

2. PS/2 keyboard to USB Changer

PS/2 (keyboard) to USB (keyboard and mouse) changer.

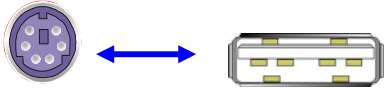

PS/2 keyboard to USB Changer

3. Daisy Chain Cable

VGA Cable: HDDDB15 Male to Male

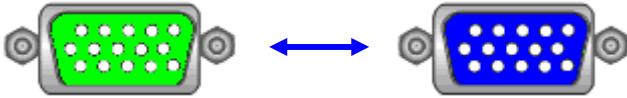

Daisy Chain Cable

Note:	Daisy chain needs the cable 15 lines fully connected. This is a special VGA cable, normal VGA cable have unconnected lines. Please contract your dealer for Daisy chain cable.
--------------	--

Appendix B Troubleshooting & Frequently Asked Questions

Question	Answer
The remote mouse doesn't work or is not synchronous	Make sure the mouse settings in IKVM-8010 / IKVM-16010 match the mouse model. There are some circumstances where the mouse synchronization process could behave incorrectly, refer to Section 3.4.3 for further explanation.
The video quality is bad or the picture is grainy	Try to correct the brightness and contrast settings (see section 4.3.1) until they are out of a range where the picture looks grainy. Use the auto adjustment feature to correct a flickering video.
Login on IKVM-8010 / IKVM-16010 fails.	Was the correct combination of user and password given? On delivery, the user "super" has the password "pass". Moreover your browser must be configured to accept cookies.
The Remote Console window can't connect to IKVM-8010 / IKVM-16010.	Possibly a firewall prevents access to the Remote Console. Make sure the TCP port numbers 443 or 80 are open for incoming TCP connection establishments.
No connection can be established to IKVM-8010 / IKVM-16010.	Check whether the network connection is working in general (ping the IP address of IKVM-8010 / IKVM-16010). If not, check network hardware. Is IKVM-8010 powered on? Check whether the IP address of IKVM-8010 / IKVM-16010 and all other IP related settings are correct! Also verify that all the IP infrastructure of your LAN, like routers etc., is correctly configured. Without a ping functioning, IKVM-8010 / IKVM-16010 can't work either.
Special key combinations, e.g. ALT+F2, ALT+F3 are intercepted by the console system and not transmitted to the host.	You have to define a so-called 'Button Key'. This can be done in the Remote Console settings.
In the browser the IKVM-8010 / IKVM-16010 pages are inconsistent or chaotic.	Make sure your browser cache settings are feasible. Especially make sure the cache settings are not set to something like "never check for newer pages". Otherwise IKVM-8010 / IKVM-16010 pages may be loaded from your browser cache and not from the card.
Windows XP doesn't awake from standby mode	This is possibly a Windows XP problem. Try not to move the mouse while XP goes in standby mode.
Can't upload the signed certificate in MacOS X	If an 'internal error' occurs while uploading the signed certificate, either change the extension of the file to .txt or add a file helper using the Internet Explorer preferences for this type of file. Make sure that the encoding is plain text and the checkbox 'use for outgoing' is checked. Another possibility is to use a Mozilla based browser.
Every time I open a dialog box with some buttons the mouse pointers are not synchronous anymore	Please check, if you have an option like "Automatically move mouse pointer to the default button of dialog boxes" enabled in the mouse settings of the operating system. This option needs to be disabled.

Appendix C Specifications

Feature	Specification
Model	IKVM-8010
Host Port Connector	VGA
Host Ports	8
Console Type	USB or PS/2
Max. Distance (KVM switch -- Host)	16 feet (5m)
Video Resolution(Local Console)	1920 x 1440
Video Resolution(Remote Console)	1680 x 1050 for CAT5-Based 500 feet remote console 1280 x 1024 for CAT5-Based 1000 feet remote console 1600 x 1200 for IP-Based remote console
Console Ports	1 Local console, plus 1 Optional Modules: CAT5-Based or IP-Based Remote Console
Flash Port	DC2.5F
CAT5-Based Remote Module	RJ-45 Connector CAT5 console up to 1000 feet away from KVM switch with superior auto-adjust RGB signals capability
IP-Based Remote Module	RJ-45 8P8C for 10/100M Ethernet DB-9 male for Configuration console, Modem, Null modem, and serial power control Mini USB 2.0 receptacle
Daisy Chain	Support Daisy Chaining with both Bus (8-layer) and Tree (2-layer) topologies Connector DB15 (Female Type)
Computers Selection	On Screen Display (OSD) Menu, Hot Key, Push Button
Hotkey	Provide various Hotkey (Scroll-Lock/ Caps-Lock/ Num-Lock/ Alt/ Ctrl/ Win)
Computer Port LED's	2 LED's per Host port: ON LINE (Red), SELECT (Green)
7-seg LED	1 set for Bank display
Security	Provide ACL (Access Control List) security function, store up to 8 independent ACL's of controllable computer lists
Multilingual OSD (On Screen Display) control	8 languages (English, France, German, Spanish, Italian, Russian, Japanese, Simplified Chinese)
Auto-Scan Intervals	5 ~ 99 Sec.
Keyboard Emulation	PS/2 or USB
Mouse Emulation	PS/2 or USB
Max. Connected Computers	Up to 8192
Housing	Metal
Power	DC Power adapter : 12V, 1A
Operation Temperature	0 ~ 50°C
Storage Temperature	-20 ~ 60°C
Humidity	0~80%, Non-Condensing
Mechanical	19" Rackmount, 1U
Dimension (mm)	444.5 * 160 * 44.3

Feature	Specification
Model	IKVM-16010
Host Port Connector	VGA
Host Ports	16
Console Type	USB or PS/2
Max. Distance (KVM switch -- Host)	16 feet (5m)
Video Resolution(Local Console)	1920 x 1440
Video Resolution(Remote Console)	1680 x 1050 for CAT5-Based 500 feet remote console 1280 x 1024 for CAT5-Based 1000 feet remote console 1600 x 1200 for IP-Based remote console
Console Ports	1 Local console, plus 1 Optional Modules: CAT5-Based or IP-Based Remote Console
Flash Port	DC2.5F
CAT5-Based Remote Module	RJ-45 Connector CAT5 console up to 1000 feet away from KVM switch with superior auto-adjust RGB signals capability
IP-Based Remote Module	RJ-45 8P8C for 10/100M Ethernet DB-9 male for Configuration console, Modem, Null modem, and serial power control Mini USB 2.0 receptacle
Daisy Chain	Support Daisy Chaining with both Bus (8-layer) and Tree (2-layer) topologies Connector DB15 (Female Type)
Computers Selection	On Screen Display (OSD) Menu, Hot Key, Push Button
Hotkey	Provide various Hotkey (Scroll-Lock/ Caps-Lock/ Num-Lock/ Alt/ Ctrl/ Win)
Computer Port LED's	2 LED's per Host port: ON LINE (Red), SELECT (Green)
7-seg LED	1 set for Bank display
Security	Provide ACL (Access Control List) security function, store up to 8 independent ACL's of controllable computer lists
Multilingual OSD (On Screen Display) control	8 languages (English, France, German, Spanish, Italian, Russian, Japanese, Simplified Chinese)
Auto-Scan Intervals	5 ~ 99 Sec.
Keyboard Emulation	PS/2 or USB
Mouse Emulation	PS/2 or USB
Max. Connected Computers	Up to 8192
Housing	Metal
Power	DC Power adapter : 12V, 1A
Operation Temperature	0 ~ 50°C
Storage Temperature	-20 ~ 60°C
Humidity	0~80%, Non-Condensing
Mechanical	19" Rackmount, 1U
Dimension (mm)	444.5 * 160 * 44.3