

## User's Manual

**GSD-800S**

**GSD-802S**

**8-Port Gigabit Web Smart  
Ethernet Switch**

**GSD-802PS**

**8-Port Gigabit Web Smart  
PoE Switch**



## Trademarks

Copyright © PLANET Technology Corp. 2010.

Contents subject to which revision without prior notice.

PLANET is a registered trademark of PLANET Technology Corp. All other trademarks belong to their respective owners.

## Disclaimer

PLANET Technology does not warrant that the hardware will work properly in all environments and applications, and makes no warranty and representation, either implied or expressed, with respect to the quality, performance, merchantability, or fitness for a particular purpose.

PLANET has made every effort to ensure that this User's Manual is accurate; PLANET disclaims liability for any inaccuracies or omissions that may have occurred.

Information in this User's Manual is subject to change without notice and does not represent a commitment on the part of PLANET. PLANET assumes no responsibility for any inaccuracies that may be contained in this User's Manual. PLANET makes no commitment to update or keep current the information in this User's Manual, and reserves the right to make improvements to this User's Manual and/or to the products described in this User's Manual, at any time without notice.

If you find information in this manual that is incorrect, misleading, or incomplete, we would appreciate your comments and suggestions.

## FCC Warning

This equipment has been tested and found to comply with the limits for a Class A digital device, pursuant to Part 15 of the FCC Rules. These limits are designed to provide reasonable protection against harmful interference when the equipment is operated in a commercial environment. This equipment generates, uses, and can radiate radio frequency energy and, if not installed and used in accordance with the Instruction manual, may cause harmful interference to radio communications. Operation of this equipment in a residential area is likely to cause harmful interference in which case the user will be required to correct the interference at whose own expense.

## CE Mark Warning

This is a Class A product. In a domestic environment, this product may cause radio interference, in which case the user may be required to take adequate measures.

## Energy Saving Note of the Device

This power required device does not support Standby mode operation. For energy saving, please remove the power cable to disconnect the device from the power circuit.

Without removing power cable, the device will still consuming power from the power source. In the view of Saving the Energy and reduce the unnecessary power consuming, it is strongly suggested to remove the power connection for the device if this device is not intended to be active.

## WEEE Warning

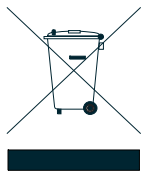

To avoid the potential effects on the environment and human health as a result of the presence of hazardous substances in electrical and electronic equipment, end users of electrical and electronic equipment should understand the meaning of the crossed-out wheeled bin symbol. Do not dispose of WEEE as unsorted municipal waste and have to collect such WEEE separately.

## Revision

PLANET Web Smart Gigabit Ethernet Switch User's Manual

**FOR MODELS:** GSD-800S / GSD-802S / GSD-802PS

**REVISION:** GSD-800Sv3 / GSD-802Sv1 / GSD-802PSv1 (APRIL.2010)

**Part No.:** 2080-A35040-005

## TABLE OF CONTENTS

<b>1. INTRODUCTION.....</b>	<b>1</b>
PACKAGE CONTENTS .....	1
HOW TO USE THIS MANUAL .....	1
PRODUCT FEATURES .....	2
PRODUCT SPECIFICATION .....	3
<b>2. INSTALLATION.....</b>	<b>5</b>
2.1 PRODUCT DESCRIPTION.....	5
2.1.1 Product Overview .....	5
2.1.2 Switch Front Panel.....	6
2.1.3 LED Indicators .....	6
2.1.4 Switch Rear Panel.....	7
2.2 INSTALL THE SWITCH .....	8
2.2.1 Desktop Installation .....	8
2.2.2 Rack Mounting .....	9
2.2.3 Installing the SFP transceiver .....	10
<b>3. SWITCH MANAGEMENT.....</b>	<b>12</b>
3.1 OVERVIEW .....	12
3.2 MANAGEMENT METHODS.....	12
3.2.1 Web Management.....	12
3.2.2 Login the Switch.....	13
<b>4. CONFIGURATION.....</b>	<b>14</b>
4.1 MAIN MENU .....	14
4.2 SYSTEM .....	16
4.2.1 System Info.....	16
4.2.2 Misc Configuration.....	17
4.3 PORT CONFIGURATION .....	19
4.4 PORT MIRRORING.....	21
4.5 VLANs .....	22
4.5.1 VLAN Membership .....	23
4.5.2 Per Port Configuration.....	26
4.5.3 VLAN setting example:.....	28
4.6 RAPID SPANNING TREE .....	36
4.6.1 RSTP System Configuration.....	37
4.6.2 RSTP Port Configuration.....	38
4.6.3 RSTP Status.....	39
4.7 LINK AGGREGATION .....	42
4.7.1 Port Trunk.....	42
4.7.2 LACP.....	43
4.7.3 LACP Status .....	45

4.8 IGMP SNOOPING .....	47
4.8.1 IGMP Snooping Configuration.....	47
4.8.2 IGMP Snooping Status .....	48
4.8.3 Multicast Group Table .....	50
4.9 QUALITY OF SERVICE.....	51
4.9.1 802.1p QoS Mode.....	52
4.9.2 DSCP QoS Mode.....	54
4.10 802.1X MANAGEMENT.....	55
4.10.1 RADIUS Server Configuration.....	56
4.10.2 Port Access Control .....	58
4.11 MAC ADDRESSES .....	60
4.11.1 Dynamic Address Table.....	60
4.11.2 Static MAC Address .....	61
4.12 TOOLS.....	62
4.12.1 Reboot.....	62
4.12.2 Factory Reset .....	62
4.12.3 Firmware Upgrade .....	63
4.12.4 Configuration Upload .....	64
4.12.5 Ping.....	66
4.12.6 Cable Diagnostics .....	67
4.12.7 Web Smart Function .....	69
4.13 STATUS.....	73
4.13.1 Port Statistics .....	73
4.13.2 LACP Status .....	74
4.13.3 RSTP Status.....	74
4.13.4 IGMP Snooping Status .....	74
4.13.5 Multicast Group Status .....	74
4.14 PoE CONFIGURATION ( GSD-802PS ONLY).....	76
<b>5. SWITCH OPERATION.....</b>	<b>78</b>
5.1 ADDRESS TABLE .....	78
5.2 LEARNING.....	78
5.3 FORWARDING & FILTERING.....	78
5.4 STORE-AND-FORWARD.....	78
5.5 AUTO-NEGOTIATION.....	79
5-6 IGMP SNOOPING .....	79
<b>6. TROUBLESHOOTING.....</b>	<b>81</b>
<b>APPENDIX A .....</b>	<b>82</b>
A.1 SWITCH'S RJ-45 PIN ASSIGNMENTS.....	82
A.2 10/100Mbps, 10/100BASE-TX .....	82
A.3 RJ-45 CABLE PIN ASSIGNMENT.....	83

# 1. INTRODUCTION

## Package Contents

Check the contents of your package for following parts:

- Web Smart Gigabit Ethernet Switch x1
- User's Manual CD x1
- Quick installation guide x1
- Power cord x1
- Rubber feet x 4
- Rack mount accessory kit x 1 (GSD-802PS Only)

If any of these are missing or damaged, please contact your dealer immediately, if possible, retain the carton including the original packing material, and use them against to repack the product in case there is a need to return it to us for repair.

## How to Use This Manual

**This Web Smart Gigabit Ethernet Switch User Manual is structured as follows:**

- **Section 2, Installation**  
It explains the functions of Switch and how to physically install the Switch.
- **Section 3, Switch Management**  
It contains information about the how to manage the Switch.
- **Section 4, Configuration**  
The section explains how to manage the Switch by Web interface.
- **Section 5, Switch operation**
- The section explains the basic layer 2 theories and functions.
- **Appendices**  
It contains cable information of Switch.

In the following section, the term “**Gigabit Ethernet Switch**” means the GSD-800S/GSD-802 and GSD-802PS.

## Product Features

### ■ Physical Port

#### **GSD-800S**

- 8-Port 10/100/1000Base-T RJ-45 Copper ports.

#### **GSD-802S**

- 8-Port 10/100/1000Base-T RJ-45 Copper with 2 Shared SFP / mini-GBIC slots

#### **GSD-802PS**

- 8-Port 10/100/1000Base-T RJ-45 Copper with 2 Shared SFP / mini-GBIC slots

### ■ Generic Features

- Comply with IEEE 802.3, 10Base-T, IEEE 802.3u, 100Base-TX, IEEE 802.3ab, 1000Base-T, IEEE 802.3z, 1000Base-SX/LX, Ethernet standard
- Auto-MDI/MDI-X detection on each RJ-45 port
- Prevents packet loss with back pressure (half-duplex) and 802.3x PAUSE frame flow control (Full-duplex)
- 8K MAC address table, automatic source address learning and ageing
- 16Gbps switch fabric, non-blocking switch architecture
- 9K Jumbo Frame support at all speed (10/100/1000 Mbps)

### ■ Layer-2 Switching

- Support port-based and 802.1q VLAN function, up to 64 VLAN groups
- 802.1w Rapid-Spanning Tree protocol support
- Link Aggregation support static mode and LACP (802.3ad) - up to 4 Trunk groups, each trunk for up to maximum 8 ports
- IGMP Snooping – multicast filtering

### ■ Quality of Service

- 4 QoS classes per port
- Traffic class assignment based on 802.1p tag, or DSCP field
- Multicast and Broadcast Storm Control as well as Flooding Control

### ■ Security

- Port Mirroring support for dedicated port monitoring
- 802.1X Port-Base access control, RADIUS Server Authentication
- Static MAC Address assign destination MAC address at specifies port

### ■ Power over Ethernet (GSD-802PS)

- Per Port PoE Full power support
- Powered Device Auto detection
- Power Interface Protection
- LED easy PoE status Monitoring

- Power feeding on/off and priority configuration
- **Management**
  - Remote Web management interface
  - Firmware upgrade through web interface
  - Cable Diagnostics technology
  - Support SNMPv1 with RFC-1213/1573-Interface group, Ethernet MIB
  - SNMP Trap

## PRODUCT SPECIFICATION

Model	GSD-800S	GSD-802S	GSD-802PS
<b>Hardware Specification</b>			
Copper Ports	8-Port 10/100/1000Base-T Auto MDI/MDI-X		
SFP/mini-GBIC slot	-	2	2
PoE Injector Ports	-	-	8
Switch architecture	Store-and-Forward		
Switch Fabric	16Gbps		
Switch throughput	11.9Mpps		
Address Table	8K entries		
Share data Buffer	176KB On-chip frame buffer		
Flow Control	Back pressure for half duplex, IEEE 802.3x Pause Frame for full duplex		
Dimensions (mm) ( W x D x H )	217 x 135 x 43.5, 1U height		330 x 155 x 43.5, 1U height
Weight	1.1kg	1.2kg	1.8 kg
Power Requirement	100-240V AC, 50-60 Hz		
Power Consumption	13.2 Watts maximum, 41.4 BTU/hr	13.2 Watts maximum, 41.4 BTU/hr	130 Watts maximum, 410 BTU/hr
PoE Power Output	-	-	48V DC, 15.4W, 350mA (Ping 1, 2, 3, 6)
<b>Layer 2 Functions</b>			
Management Interface	Web Browser, SNMPv1, v2c monitor and SNMP Trap		
Port configuration	<ul style="list-style-type: none"> <li>- Port disable/enable. Auto-negotiation 10/100/1000Mbps full and half duplex mode selection</li> <li>- Flow Control disable / enable</li> </ul>		
VLAN	Port-Based / 802.1Q Tagged Based VLAN, Up to 64 VLAN groups		
Link Aggregation	Supports 4 groups of 8-Port trunk, IEEE 802.3ad LACP		
QoS	4 Priority Queue and traffic classification based on 802.1p priority, DSCP field in IP Packet		
IGMP Snooping	IGMP (v1/v2) Snooping, up to 64 multicast Groups		
Port Mirror	One to many and the monitor mode is RX		
SNMP MIBs	RFC-1213 MIB-2 RFC-1573-Interface MIB RFC-2819 RMON MIB (Group 1)		

Standards Conformance	
<b>EMI Safety</b>	FCC Class A, CE
<b>Network Standards</b>	IEEE 802.3 Ethernet IEEE 802.3u Fast Ethernet IEEE 802.3ab Gigabit Ethernet IEEE 802.3z Gigabit Ethernet, 1000Base-SX/LX IEEE 802.1q Tagged VLAN IEEE 802.1w Rapid Spanning Tree IEEE 802.1X Port-Based Authentication IEEE 802.3ad Link Aggregation Control Protocol IEEE 802.3x Full-Duplex flow control IEEE 802.3af Power Over Ethernet ( GSD-802PS only)
<b>Operating Temperature</b>	0~50°C
<b>Storage Temperature</b>	-40~70°C
<b>Operating Humidity</b>	5% to 90% , relative humidity, non-condensing
<b>Storage Humidity</b>	5% to 90% , relative humidity, non-condensing
<b>Regulation Compliance</b>	FCC Part 15 Class A, CE



## 2. INSTALLATION

This section describes the functionalities of Gigabit Ethernet Switch's components and guides how to install it on the desktop or shelf. Basic knowledge of networking is assumed. Please read this chapter completely before continuing.

### 2.1 Product Description

The PLANET Gigabit Ethernet Switch is an 8-Port 10/100/1000Mbps Web Smart Gigabit Ethernet Switch with non-blocking wire-speed performance. With 16Gbps internal switching fabric, the Gigabit Ethernet Switch can handle extremely large amounts of data transmission in a secure topology linking to a backbone or high-power servers. The Gigabit Ethernet Switch could recognize up to 8K MAC Address table. The Gigabit Ethernet Switch offers wire-speed packet transfer performance without risk of packet loss. The high data throughput, it can provide the most convenient for user to upgrade their network to Gigabit environment.

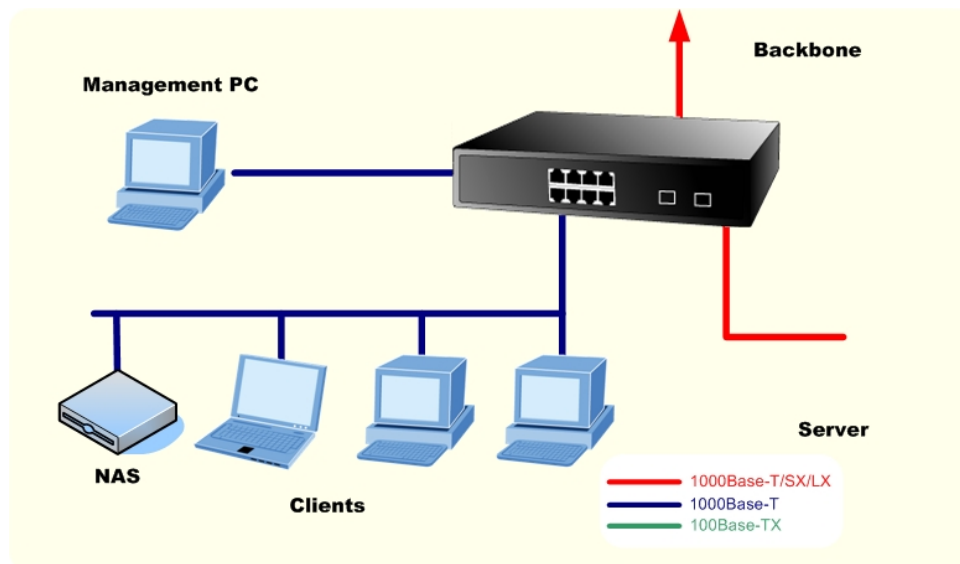

#### 2.1.1 Product Overview

PLANET Gigabit Ethernet Switch is a Web Smart Gigabit Ethernet Switch with 8 RJ-45 10/100/1000Mbps ports for high-speed network connectivity. The Gigabit Ethernet Switch can also automatically identify and determine the correct transmission speed and half/full duplex mode of the attached devices with its 8 ports. The Gigabit port can handle large amounts of data transmission in a secure topology linking to a backbone or high-power servers.

The Gigabit Ethernet Switch also supports store-and-forward forwarding scheme to ensure low latency and high data integrity, eliminates unnecessary traffic and relieves congestion on critical network paths. With an intelligent address recognition algorithm, the Gigabit Ethernet Switch could recognize up to 8K different MAC address and enables filtering and forwarding at full wire speed.

## 2.1.2 Switch Front Panel

Figure 2-1 & 2-2 & 2-3 shows a front panel of GSD-800S / GSD-802S and GSD-802PS.

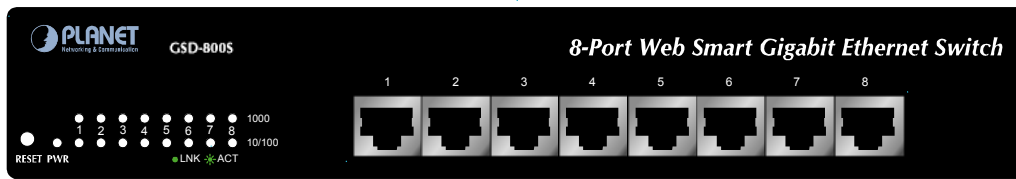

Figure 2-1 PLANET GSD-800S Front Panel

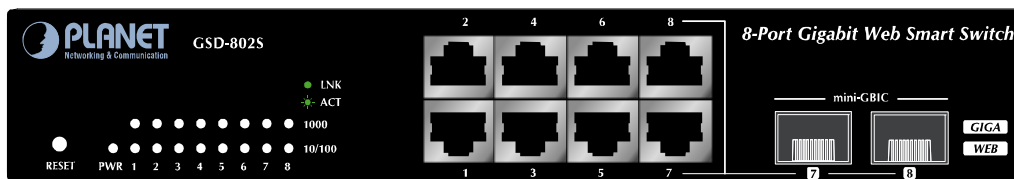

Figure 2-2 PLANET GSD-802S Front Panel

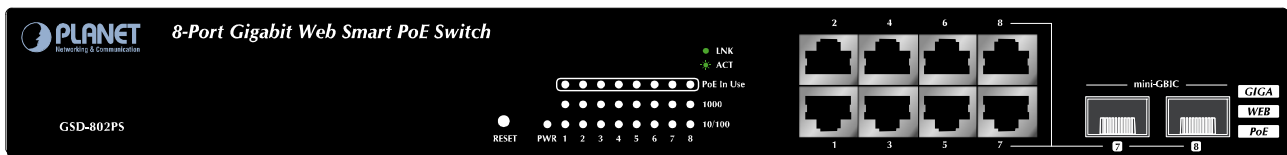

Figure 2-3 PLANET GSD-802PS Front Panel

## 2.1.3 LED Indicators

### ■ LED of GSD-800S / GSD-802S

LED	Color	Function
PWR	Green	Lights to indicate that the Switch is powered on.
1000 LNK/ACT	Green	Lights to indicate that the Switch is successfully connecting to the network at 1000Mbps. Blinks to indicate the Switch is receiving or sending data.
10/100 LNK/ACT	Green	Lights to indicate that the Switch is successfully connecting to the network at 10/100Mbps. Blinks to indicate the Switch is receiving or sending data.

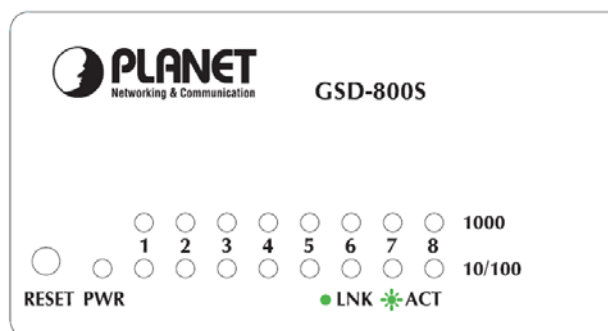

Figure 2-4 PLANET GSD-800S / GSD-802S LED panel

■ LED of GSD-802PS

LED	Color	Function
PWR	Green	Lights to indicate that the Switch is powered on.
PoE In Use	Orange	Lights to indicate the port is providing 48VDC in-line power.
1000 LNK/ACT	Green	Lights to indicate that the Switch is successfully connecting to the network at 1000Mbps. Blinks to indicate the Switch is receiving or sending data.
10/100 LNK/ACT	Green	Lights to indicate that the Switch is successfully connecting to the network at 10/100Mbps. Blinks to indicate the Switch is receiving or sending data.

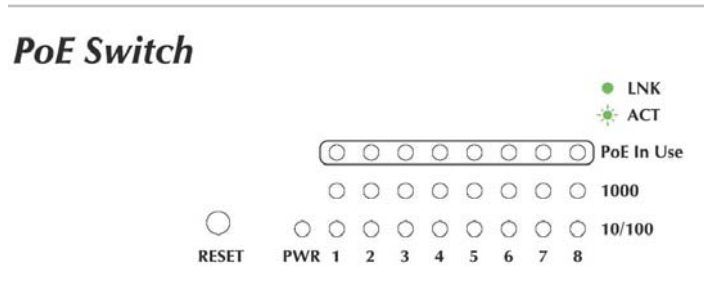

Figure 2-5 PLANET GSD-802PS LED panel

**Notice:** To press and release the RESET button. The Gigabit Ethernet Switch will back to the factory default mode. Be sure that you backup the current configuration of Gigabit Ethernet Switch; else the entire configuration will be erased when pressing the "RESET" button.

### 2.1.4 Switch Rear Panel

The rear panel of the Gigabit Ethernet Switch indicates an AC inlet power socket, which accepts input power from 100 to 240VAC, 50-60Hz.

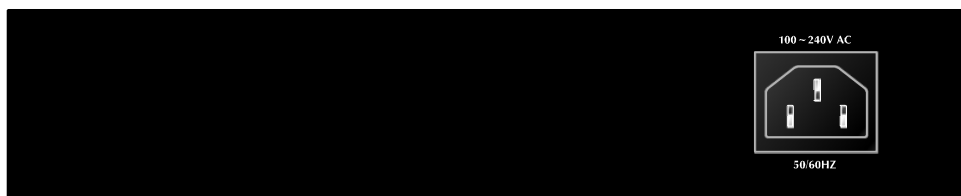

Figure 2-6 Rear Panels of GSD-800S / GSD-802S

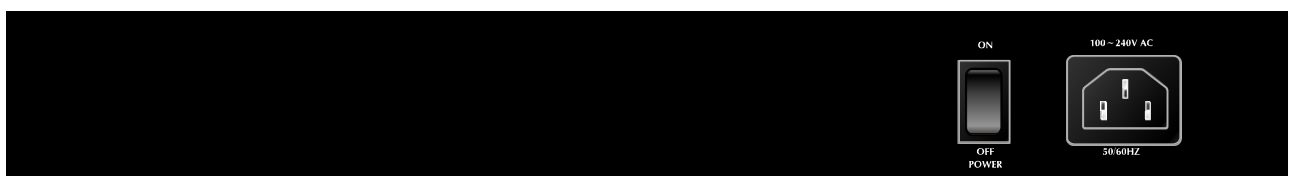

Figure 2-7 Rear Panel of GSD-802PS

**Power Notice:**

1. The device is a power-required device, it means, it will not work till it is powered. If your networks should active all the time, please consider using UPS (Uninterrupted Power Supply) for your device. It will prevent you from network data loss or network downtime.
2. In some area, installing a surge suppression device may also help to protect your Gigabit Ethernet Switch from being damaged by unregulated surge or current to the Switch or the power adapter.

## 2.2 Install the Switch

This section describes how to install your Gigabit Ethernet Switch and make connections to the Switch. Please read the following topics and perform the procedures in the order being presented. To install your Gigabit Ethernet Switch on a desktop or shelf, simply complete the following steps.

### 2.2.1 Desktop Installation

To install Gigabit Ethernet Switch on a desktop or shelf, simply complete the following steps:

**Step1:** Attach the rubber feet to the recessed areas on the bottom of the Gigabit Ethernet Switch.

**Step2:** Place the Gigabit Ethernet Switch on a desktop or shelf near an AC power source.

**Step3:** Keep enough ventilation space between the Gigabit Ethernet Switch and the surrounding objects.



**Notice:** When choosing a location, please keep in mind the environmental restrictions discussed in Chapter 1, Section 4, and Specification.

---

**Step4:** Connect your Switch to network devices.

- A. Connect one end of a standard network cable to the 10/100/1000 RJ-45 ports on the front of the Gigabit Ethernet Switch.
- B. Connect the other end of the cable to the network devices such as printer servers, workstations or routers...etc.



**Notice:** Connection to the Gigabit Ethernet Switch requires UTP Category 5 network cabling with RJ-45 tips. For more information, please see the Cabling Specification in Appendix A.

---

**Step5:** Supply power to the Switch.

- A. Connect one end of the power cable to the Gigabit Ethernet Switch.
- B. Connect the power plug of the power cable to a standard wall outlet.

When the Gigabit Ethernet Switch receives power, the Power LED should remain solid Green.

## 2.2.2 Rack Mounting

To install the switch in a **19-inch** standard rack, please follows the instructions described below.

**Notice:** Optional rack-ear for 10-inch cabinet rack mounting (RKE-10A) and 19-inch cabinet rack mounting (RKE-10B) is available upon request.

**Step1:** Place the Gigabit Ethernet Switch on a hard flat surface, with the front panel positioned towards the front side.

**Step2:** Attach the rack-mount bracket to each side of the Gigabit Ethernet Switch, with supplied screws attached to the package. Figure 2-8 shows how to attach brackets to one side of the Gigabit Ethernet Switch.

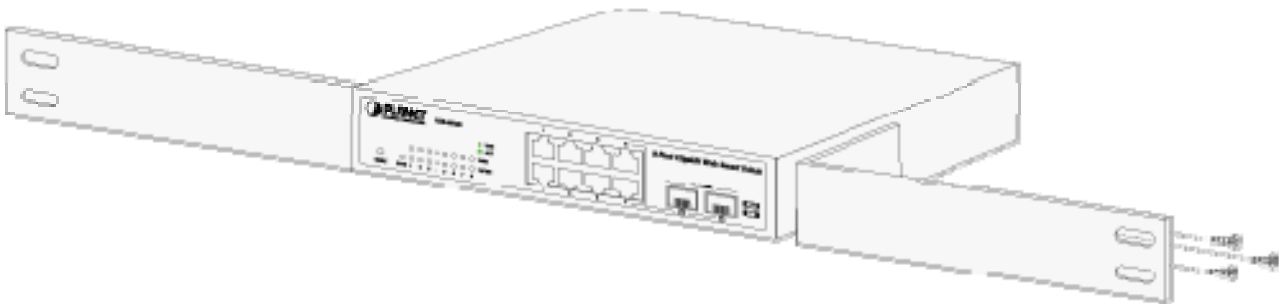

**Figure 2-8** Attach brackets to the Gigabit Ethernet Switch.

**Caution:**

You must use the screws supplied with the mounting brackets. Damage caused to the parts by using incorrect screws would invalidate the warranty.

**Step3:** Secure the brackets tightly.

**Step4:** Follow the same steps to attach the second bracket to the opposite side.

**Step5:** After the brackets are attached to the Gigabit Ethernet Switch, use suitable screws to securely attach the brackets to the rack, as shown in Figure 2-9.

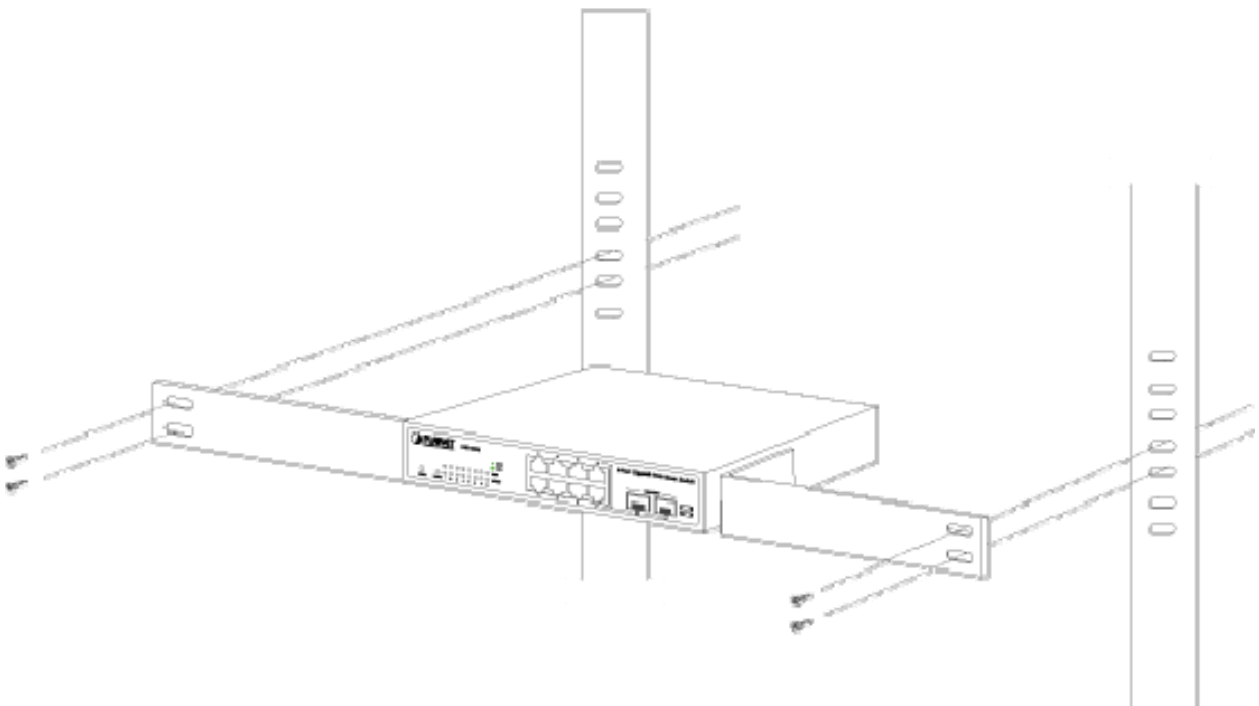

**Figure 2-9** Mounting the Gigabit Ethernet Switch in a Rack

**Step6:** Proceeds with the steps 4 and steps 5 of session 2.2.1 **Desktop Installation** to connect the network cabling and supply power to the Gigabit Ethernet Switch.

### 2.2.3 Installing the SFP transceiver

The sections describe how to insert an SFP transceiver into an SFP slot.

The SFP transceivers are hot-pluggable and hot-swappable. You can plug-in and out the transceiver to/from any SFP port without having to power down the Gigabit Ethernet Switch. As the Figure 2-10 appears.

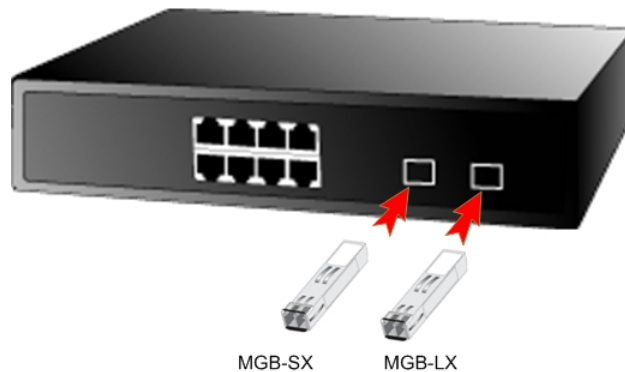

**Figure 2-10** Plug-in the SFP transceiver

#### Approved PLANET SFP Transceivers

PLANET Gigabit Ethernet Switch supports both single mode and multi mode SFP transceiver. The following list of approved PLANET SFP transceivers is correct at the time of publication:

- MGB-SX SFP (1000Base-SX SFP transceiver )
- MGB-LX SFP (1000Base-LX SFP transceiver )

---

**Notice:** It recommends using PLANET SFP transceiver on the Gigabit Ethernet Switch. If you insert a SFP transceiver that is not supported, the Gigabit Ethernet Switch will not recognize it.

---

Before connect the other switches, workstation or Media Converter.

1. Make sure both side of the SFP transfer are with the same media type, for example: 1000Base-SX to 1000Base-SX, 1000Bas-LX to 1000Base-LX.
2. Check the fiber-optic cable type match the SFP transfer model.
  - To connect to **1000Base-SX** SFP transfer, use the **multi-mode** fiber cable- with one side must be male duplex LC connector type.
  - To connect to **1000Base-LX** SFP transfer, use the **single-mode** fiber cable-with one side must be male duplex LC connector type.

### Connect the fiber cable

1. Attach the duplex LC connector on the network cable into the SFP transceiver.
2. Connect the other end of the cable to a device – switches with SFP installed, fiber NIC on a workstation or a Media Converter..
3. Check the LNK/ACT LED of the SFP slot on the front of the Gigabit Ethernet Switch. Ensure that the SFP transceiver is operating correctly.
4. Check the Link mode of the SFP port if the link failed. Co works with some fiber-NICs or Media Converters, set the Link mode to “**1000 Force**” is needed.

### Remove the transceiver module

1. Make sure there is no network activity by consult or check with the network administrator. Or through the management interface of the switch/converter (if available) to disable the port in advance.
2. Remove the Fiber Optic Cable gently.
3. Turn the handle of the MGB/MFB module to horizontal.
4. Pull out the module gently through the handle.

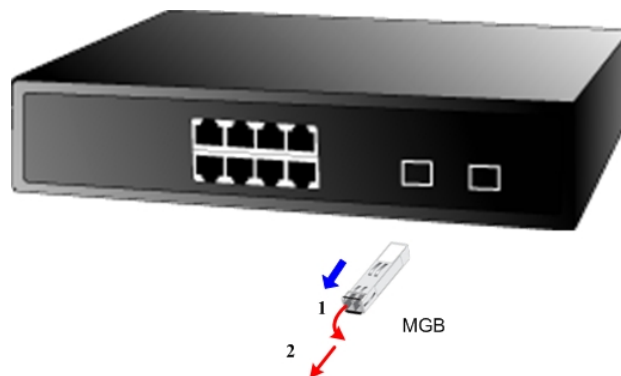



Figure 2-11 Pull out the SFP transceiver

---

 **Notice:** Never pull out the module without pull the handle or the push bolts on the module. Direct pull out the module with violent could damage the module and SFP module slot of the Gigabit Ethernet Switch.

---

## 3. SWITCH MANAGEMENT

This chapter describes how to manage the Gigabit Ethernet Switch. Topics include:

- Overview
- Management methods
- Assigning an IP address to the Gigabit Ethernet Switch
- Logging on to the Gigabit Ethernet Switch

### 3.1 Overview

This chapter gives an overview of switch management. The Gigabit Ethernet Switch provides a simply WEB **browser interface**. Using this interface, you can perform various switch configuration and management activities, including:

- **System**
- **Port Configuration**
- **Port Mirroring**
- **Storm Control**
- **VLANs**
- **Rapid Spanning Tree**
- **Link Aggregation**
- **IGMP Snooping**
- **Quality of Service**
- **802.1X Management**
- **POE Configuration (GSD-802PS Only)**
- **MAC Address**
- **Tools**
- **Status**

Please refer to the following Chapter 4 for more details.

### 3.2 Management Methods

The way to manage the Gigabit Ethernet Switch:

- Web Management via a network or dial-up connection.

#### 3.2.1 Web Management

The PLANET Gigabit Ethernet Switch provides a built-in browser interface. You can manage the Gigabit Ethernet Switch remotely by having a remote host with web browser, such as Microsoft Internet Explorer, Netscape Navigator or Mozilla Firefox.

Using this management method:



The Gigabit Ethernet Switch must have an Internet Protocol (IP) address accessible for the remote host.

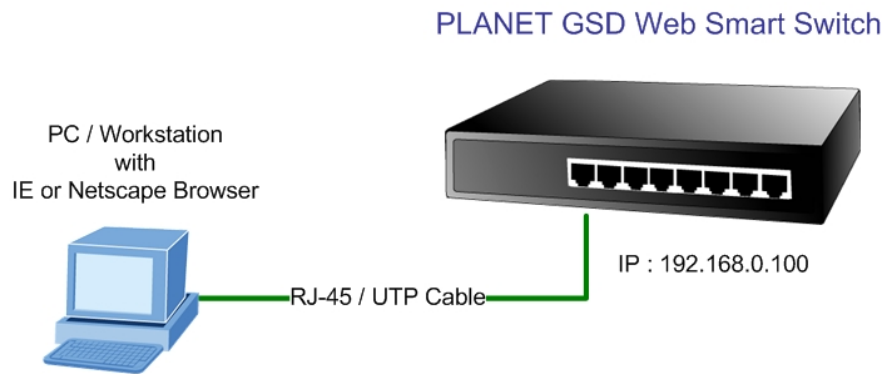

### 3.2.2 Login the Switch

Before you start configure the Gigabit Ethernet Switch, please note the Gigabit Ethernet Switch is configured through an Ethernet connection, make sure the manager PC must be set on same the **IP subnet address**. For example, the default IP address of the Gigabit Ethernet Switch is **192.168.0.100**, then the manager PC should be set at 192.168.0.x (where x is a number between 2 and 254), and the default subnet mask is 255.255.255.0. Use Internet Explorer 5.0 or above Web browser. Enter IP address **http://192.168.0.100** (the factory-default IP address) to access the Web interface.

When the following login screen appears, please enter the default password "**admin**" and press Login to enter the main screen of Gigabit Ethernet Switch. The login screen in Figure 3-1 appears.

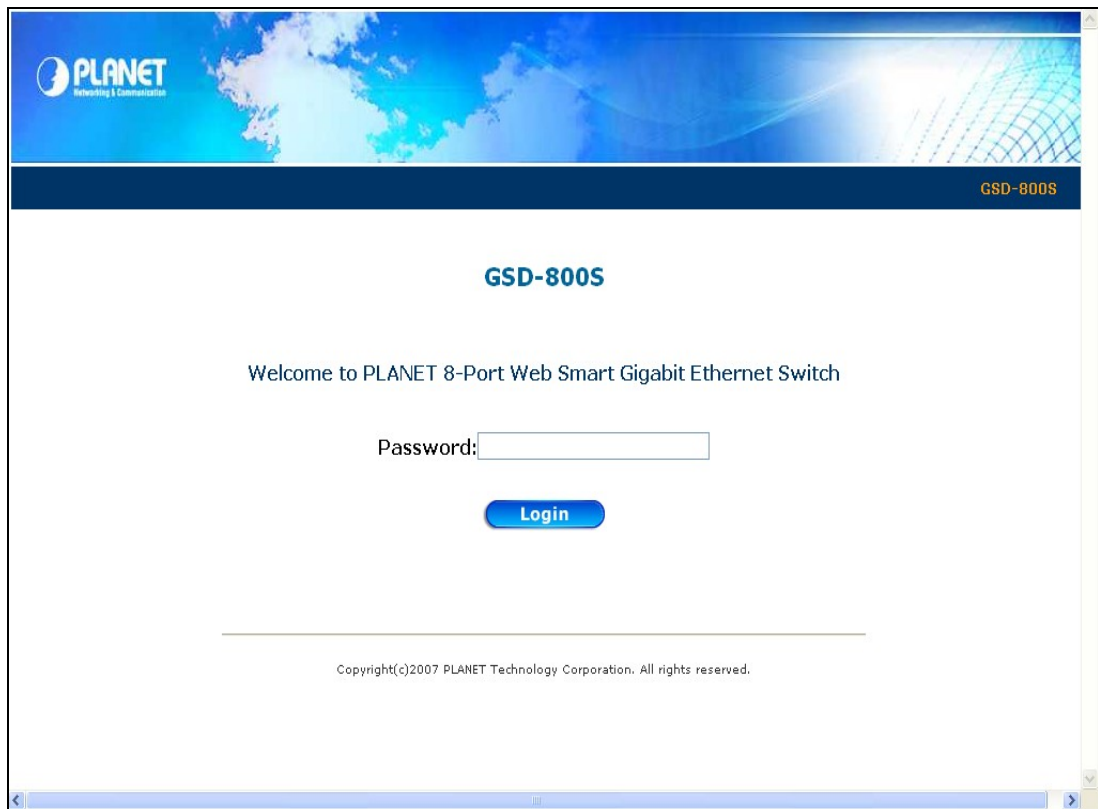

**Figure 3-1** Web Login screen of Gigabit Ethernet Switch



**Notice:**

1. For security reason, please change and memorize the new password after this first setup.
2. Only accept command in lowercase letter under web interface.

## 4. CONFIGURATION

The Gigabit Ethernet Switch provide Web interface for Switch smart function configuration and make the Switch operate more effectively - They can be configured through the Web Browser. A network administrator can manage and monitor the Gigabit Ethernet Switch from the local LAN. This section indicates how to configure the Gigabit Ethernet Switch to enable its smart function.

### Notice:

The following section will base on the web screens of GSD-800S, for GSD-802S/802PS the display will be the same to GSD-800S.

### 4.1 Main Menu

After a successful login, the main screen appears, the main screen displays the Switch status. The screen in Figure 4-1 appears.



Figure 4-1 Web Main screen

As listed at the left of the main screen, the configurable smart functions are shown as below:

- ◆ **System** – Check the hardware, software version and System MAC address. Setting the IP address and SNMP management for the Gigabit Ethernet Switch.
- ◆ **Port Configuration** - Setup per port Speed/Duplex mode, Flow Control and jumbo frame.
- ◆ **Port Mirroring** - dedicated port monitoring for incoming packets.
- ◆ **VLANs** – Configure VLAN Member / Port Configuration.
- ◆ **Rapid Spanning Tree** – Configure Rapid spanning tree topography for any arrangement of bridges.
- ◆ **Link Aggregation** – Port Trunk / LACP.

- ◆ **IGMP Snooping** - Enables or disables IGMP Snooping on the device to filter the multicast stream.
- ◆ **Quality of Service** – Mapping the packet level to classify the packets priority.
- ◆ **802.1X Management** – Specify ports with network access control.
- ◆ **MAC Address** – Dynamic Address Table / Static MAC Address.
- ◆ **Tools** – Reboot / Factory Reset / Firmware Update / Configuration Upload / Ping / Cable Diagnostic/ Web Smart function.
  
- ◆ **Status** – Port Statistics / LACP Status / RSTP Status / IGMP Snooping Status / Multicast Group Status.

## 4.2 System

### 4.2.1 System Info

The System Info page provides information for the current device information. System Info page helps a switch administrator to identify the firmware / hardware version and IP subnet address / DHCP server IP address. The screen in Figure 4-2 appears.

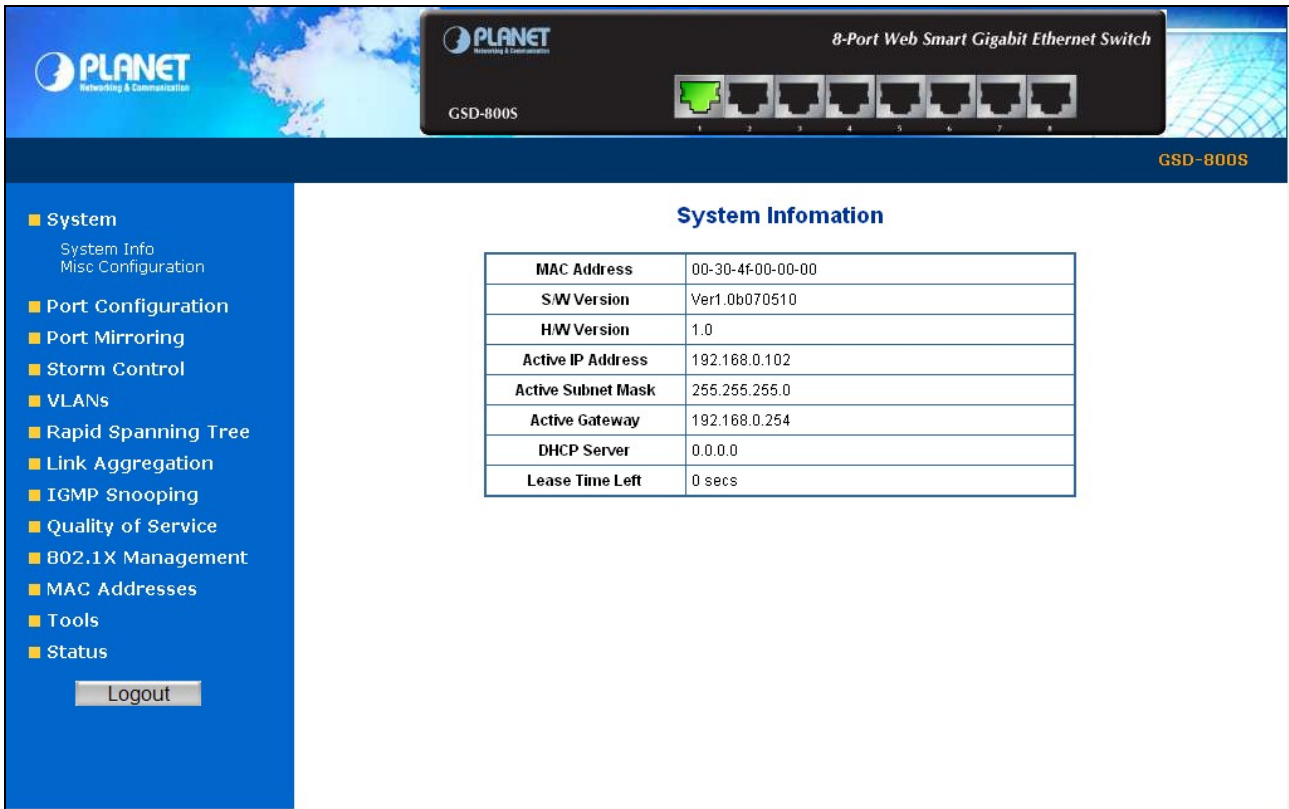

The screenshot shows the Planet GSD-800S web management interface. The top header includes the Planet logo and the device name '8-Port Web Smart Gigabit Ethernet Switch'. A navigation menu on the left lists various configuration options. The main content area is titled 'System Information' and contains a table with the following data:

System Information	
MAC Address	00-30-4f-00-00-00
SW Version	Ver1.0b070510
HW Version	1.0
Active IP Address	192.168.0.102
Active Subnet Mask	255.255.255.0
Active Gateway	192.168.0.254
DHCP Server	0.0.0.0
Lease Time Left	0 secs

Figure 4-2 System Information screen

The page includes the following fields:

- **MAC Address** Specifies the device MAC address.
- **S/W Version** The current software version running on the device.
- **H/W Version** The current hardware versions running on the device.
- **Active IP Address** The current IP Address of the device. The IP Address could be manual assigned or get via DHCP server.
- **Active Subnet Mask** The current IP Subnet Mask setting on the device.
- **Active Gateway** The current IP Gateway of the device.
- **DHCP Server** If the IP address is got and assigned via a DHCP server, the field shows the IP Address of the DHCP server.
- **Lease Time left** If the IP address of the device be assigned via a DHCP Server, a DHCP lease time would be apply to the device too. The lease time left shows the left time if the device didn't request the IP Address to the DHCP server, then the IP address will be released.

### 4.2.2 Misc Configuration

The Misc Configuration includes the System name, Location name, Login Timeout, IP Address, Subnet Mask and Gateway. Through the Web Switch Utility, you can easily recognize the device by using the System Name and the Location Name. The Login Timeout is to set the idle time-out for security issue, when there is no action in running the Web Switch Utility and the time is up, you must re-login to Web Switch Utility before you set the Utility. Fill up the IP Address, Subnet Mask and Gateway for the device. The screen in Figure 4-3 appears.

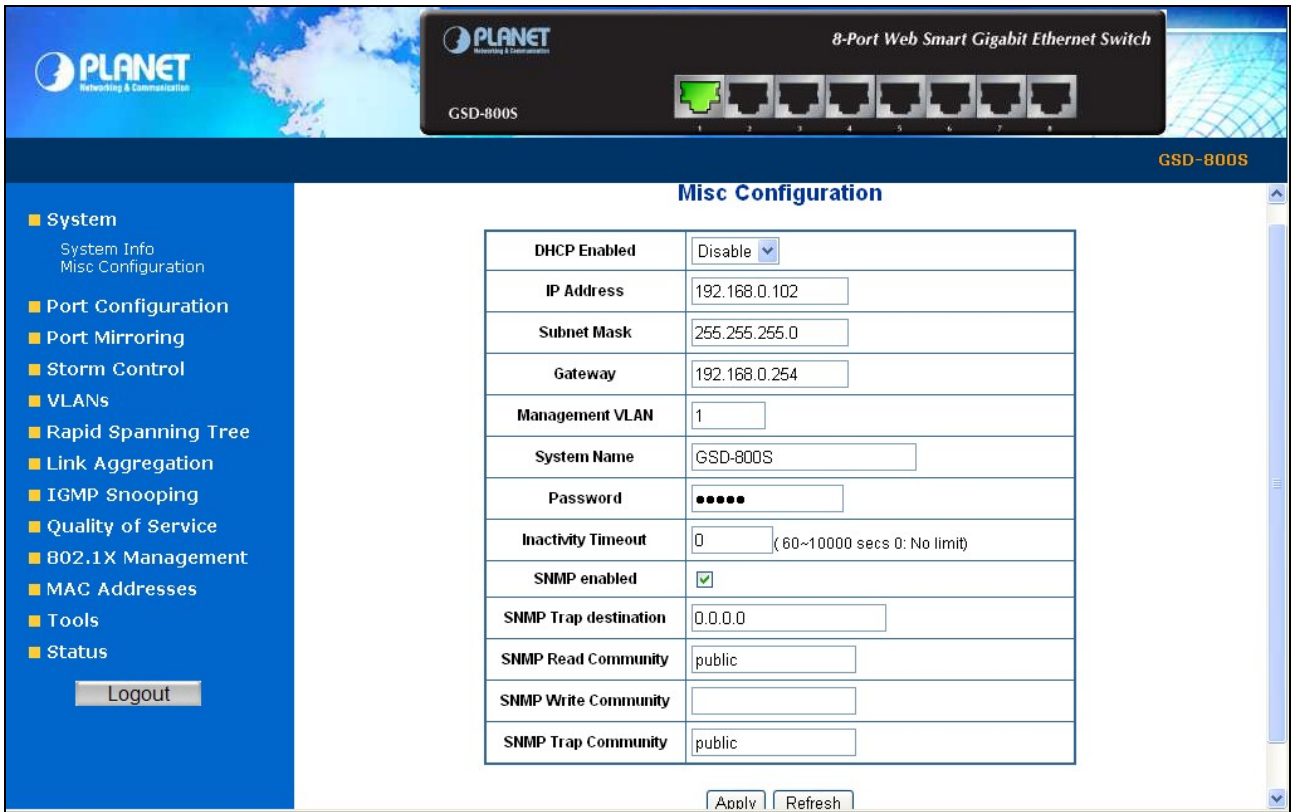

Figure 4-3 Misc Configuration screen

The page includes the following configurable data:

<b>DHCP Enable</b>	Choose what the switch should do following power-up: transmit a DHCP request, or manual setting (Disable). The factory default is Disable.
<b>IP Address</b>	The IP address of the interface. The factory default value is <b>192.168.0.100</b>
<b>Subnet Mask</b>	The IP subnet mask for the interface. The factory default value is <b>255.255.255.0</b>
<b>Gateway</b>	The default gateway for the IP interface. The factory default value is 192.168.0.254.
<b>Management VLAN</b>	Specifies the management VLAN ID of the switch. It may be configured to any value in the range of 1 - 4093. The management VLAN is used for management of the switch.
<b>System Name</b>	Defines the user-defined device name.
<b>Password</b>	This function provides administrator to secure Web login.
<b>Inactivity Timeout</b>	Specifies a time period for the user login. The web interface will be auto logout if there're no actions from the login user.

The default value is **300** seconds; 0 means no inactivity time limit.

<b>SNMP Enable</b>	Enable or Disable the SNMP function of the device. While set to enable, the manager could remotely get the interface status and received the traps information.
<b>SNMP Trap destination</b>	The Trap function enables the Switch to monitor the Trap through the Web Switch Utility, set the Trap IP Address of the manager workstation where the trap to be sent.
<b>SNMP Read Community</b>	Functions as a password and used to authenticate the access right of the device. The Read Community is restricted to read-only, for all MIBs except the community table, for which there is no access.
<b>SNMP write Community</b>	Functions as a password and used to authenticate the access right of the device. The Write Community accesses the device both read and write - configure to the device via SNMP.
<b>SNMP Trap Community</b>	Identifies the community string of the trap manager.

---

---

 **Notice:** After change the default password, if you forget the password. Please press and release the **“Reset”** button in the front panel of Gigabit Ethernet Switch, the current setting includes VLAN, will be lost and the Gigabit Ethernet Switch will restore to the default mode.

---

## 4.3 Port Configuration

This function allows displaying each port's status. The Link Status in the screen displays the current connection speed and duplex mode; else this function will show **down** when the port is disconnected. Press the "**Refresh**" button to renew the screen. The screen in Figure 4-4 appears.

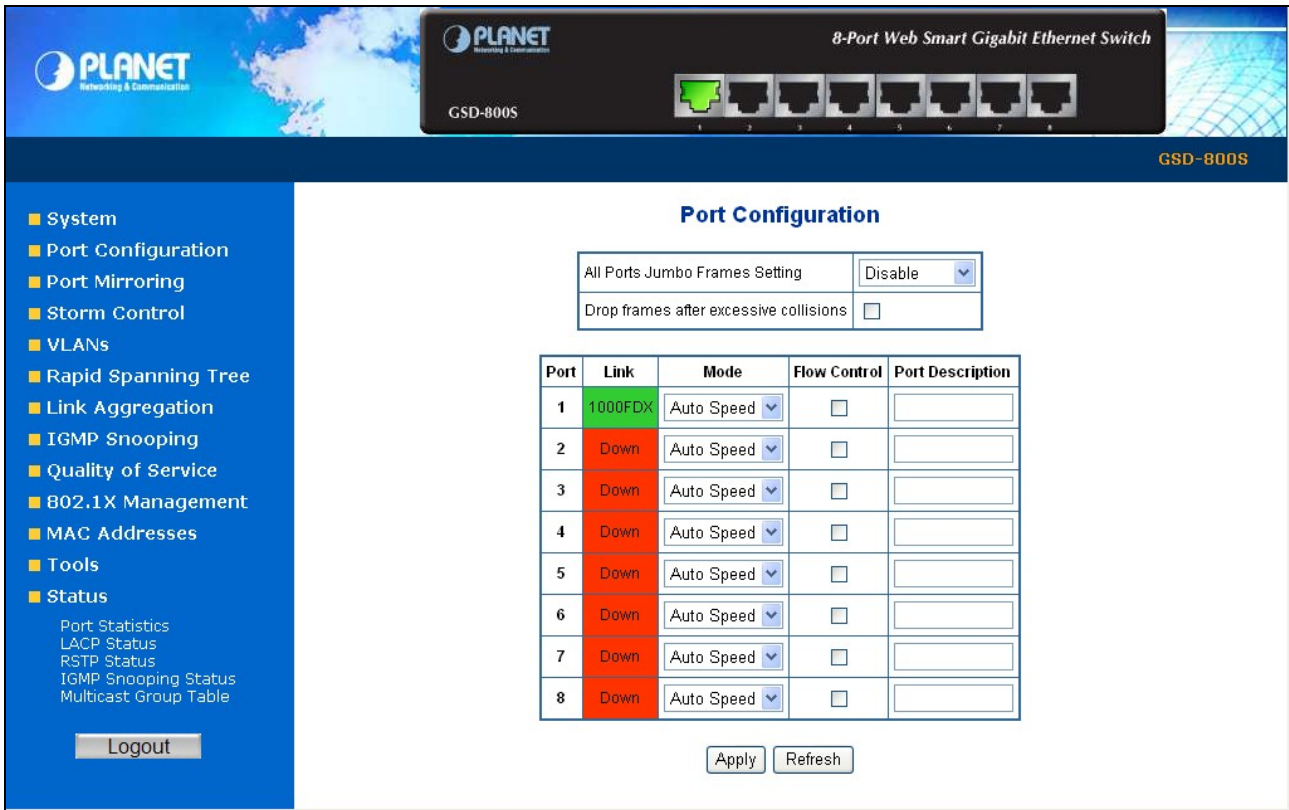

Figure 4-4 Port Configuration screen

The page includes the following configurable data:

- |   |   |
|---|---|
| <ul style="list-style-type: none"> <li>• <b>All Ports Jumbo Frames Setting</b></li> </ul>         | <p>The maximum Ethernet frame size the interface supports or is configured, including Ethernet header, CRC, and payload. Draw the menu bar to select the mode.</p> <ul style="list-style-type: none"> <li>• Disable - The default maximum frame size is 1518.</li> <li>• 4096 Kbytes – Set the maximum frame size to 4096 Bytes.</li> <li>• 9600 Kbytes - Set the maximum frame size to 9600 Bytes.</li> </ul>  |
| <ul style="list-style-type: none"> <li>• <b>Drop frames after excessive collisions</b></li> </ul> | <p>Enable or Disable the device to drop frames once the excessive collisions be detected.</p>   |
| <ul style="list-style-type: none"> <li>• <b>Port</b></li> </ul>                                   | <p>Indicate port 1 to port 8.</p>   |
| <ul style="list-style-type: none"> <li>• <b>Mode</b></li> </ul>                                   | <p>Allow configuring the port speed and operation mode. Draw the menu bar to select the mode.</p> <ul style="list-style-type: none"> <li>• <b>Auto Speed</b> - Setup Auto negotiation.</li> <li>• <b>10 half</b> - Force sets 10Mbps/Half-Duplex mode.</li> <li>• <b>10 Full</b> - Force sets 10Mbps/Full-Duplex mode.</li> <li>• <b>100 half</b> - Force sets 100Mbps/Half-Duplex mode.</li> <li>• <b>100 full</b> - Force sets 100Mbps/Full-Duplex mode.</li> <li>• <b>1000 full</b> - Force sets 1000Mbps/Full-Duplex mode.</li> <li>• <b>Disable</b> - Shutdown the port manually.</li> </ul> |

- **Flow Control** Allow **Enable** or **Disable** flow control for selected port.
  - **Enable** – 802.3x flow control is enabled on Full-Duplex mode or Backpressure is enabled on Half-Duplex mode.
  - **Disable** – No flow control or backpressure function on no matter Full-Duplex or Half-Duplex mode.
- **Port Description** Can key in the description for the port.



**Note:** When set each port to run at 100M Full, 100M Half, 10M Full, and 10M Half-speed modes. The Auto-MDIX function will disable.

---



## 4.4 Port Mirroring

This function provide to monitoring network traffic that forwards a copy of each incoming or outgoing packet from one port of a network Switch to another port where the packet can be studied. It enables the manager to keep close track of switch performance and alter it if necessary. The Port Mirroring screen in Figure 4-5 appears.

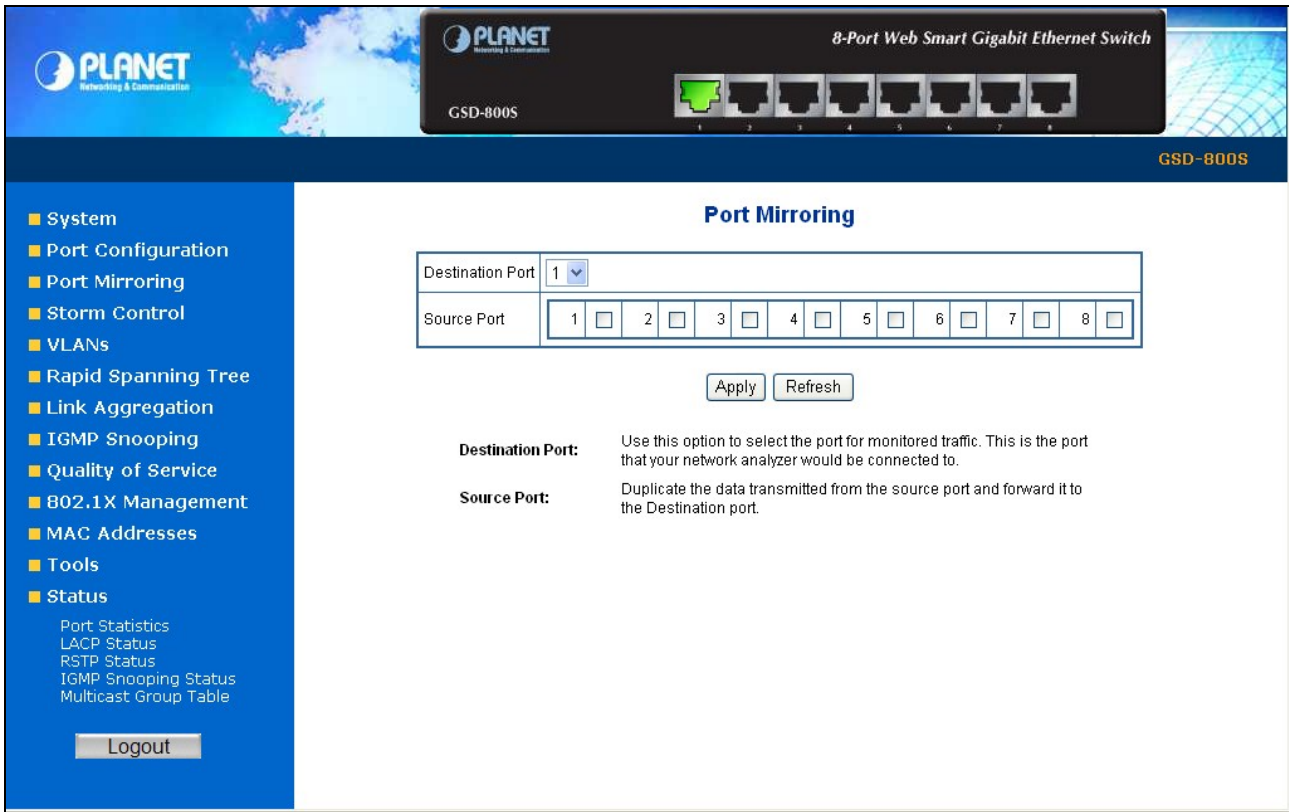

Figure 4-5 Mirror Setting screen

The page includes the following configurable data:

• <b>Destination Port</b>	Use this option to select the port for monitored traffic. This is the port that your network analyzer would be connected to – such as NAI Sniffer Pro or Ethereal.
• <b>Source Port</b>	Duplicate the data transmitted from the source port and forward it to the Destination port.

Configuring the port mirroring by assigning a source port from which to copy all packets and a destination port where those packets will be sent.

---

**Note:** With the Chipset specification – the GSD-800S/GSD-802S/GSD-802PS port mirroring support **RX (receive) mode only** - this mode will duplicate the data that send to the source and forward to the destination port.

---

## 4.5 VLANs

A Virtual LAN (VLAN) is a logical network grouping that limits the broadcast domain. It allows you to isolate network traffic so only members of the VLAN receive traffic from the same VLAN members. Basically, creating a VLAN from a switch is logically equivalent of reconnecting a group of network devices to another Layer 2 switch. However, all the network devices are still plug into the same switch physically.

The Gigabit Ethernet Switch supports 802.1Q (tagged-based) and Port-Base VLAN setting in web management page. In the default configuration, VLAN support is “**802.1Q**”.

### Port-based VLAN

Port-based VLAN limit traffic that flows into and out of switch ports. Thus, all devices connected to a port are members of the VLAN(s) the port belongs to, whether there is a single computer directly connected to a switch, or an entire department.

On port-based VLAN, NIC do not need to be able to identify 802.1Q tags in packet headers. NIC send and receive normal Ethernet packets. If the packet's destination lies on the same segment, communications take place using normal Ethernet protocols. Even though this is always the case, when the destination for a packet lies on another switch port, VLAN considerations come into play to decide if the packet is dropped by the Switch or delivered.

### IEEE 802.1Q VLANs

IEEE 802.1Q (tagged) VLAN are implemented on the Switch. 802.1Q VLAN require tagging, which enables them to span the entire network (assuming all switches on the network are IEEE 802.1Q-compliant).

VLAN allow a network to be segmented in order to reduce the size of broadcast domains. All packets entering a VLAN will only be forwarded to the stations (over IEEE 802.1Q enabled switches) that are members of that VLAN, and this includes broadcast, multicast and unicast packets from unknown sources.

VLAN can also provide a level of security to your network. IEEE 802.1Q VLAN will only deliver packets between stations that are members of the VLAN. Any port can be configured as either tagging or untagging. The untagging feature of IEEE 802.1Q VLAN allows VLAN to work with legacy switches that don't recognize VLAN tags in packet headers. The tagging feature allows VLAN to span multiple 802.1Q-compliant switches through a single physical connection and allows Spanning Tree to be enabled on all ports and work normally.

Any port can be configured as either tagging or untagging. The untagging feature of IEEE 802.1Q VLAN allow VLAN to work with legacy switches that don't recognize VLAN tags in packet headers. The tagging feature allows VLAN to span multiple 802.1Q-compliant switches through a single physical connection and allows Spanning Tree to be enabled on all ports and work normally.

## 4.5.1 VLAN Membership

This function group individual ports into a small “**Virtual**” network of their own to be independent of the other ports. The screen in Figure 4-6 appears.

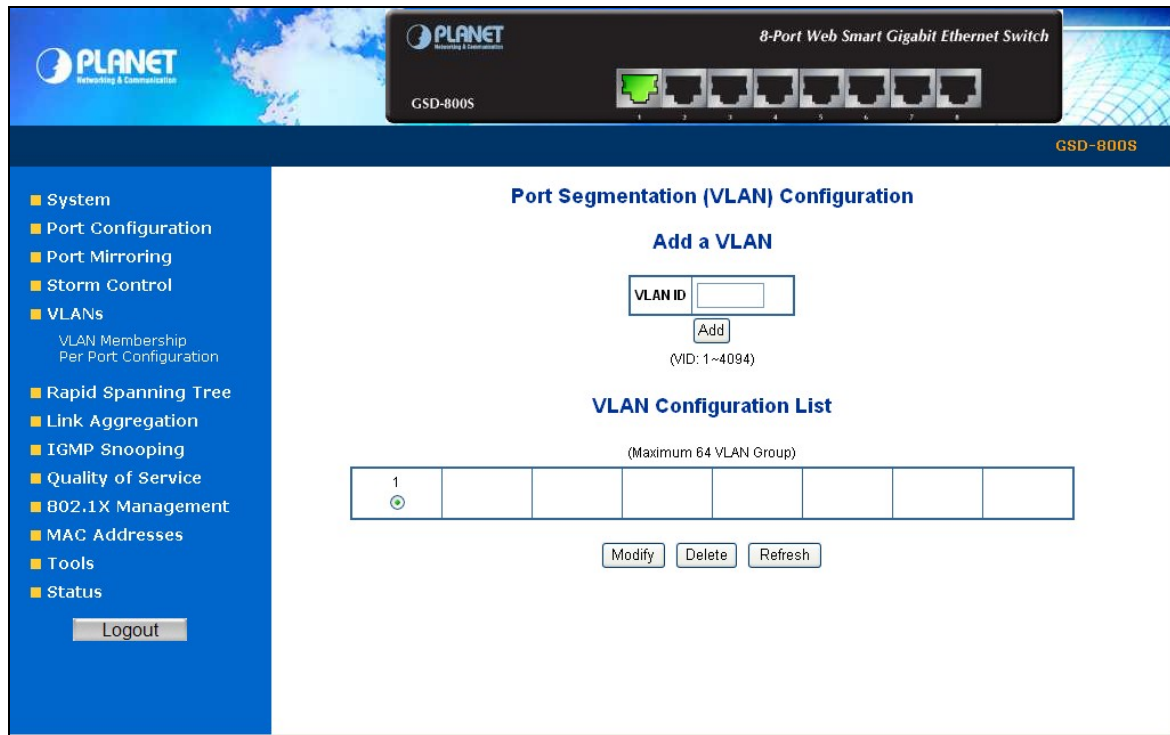

Figure 4-6 VLAN Membership screen

The page includes the following items:

• <b>VLAN ID</b>	Specify the VLAN Identifier for the new VLAN. (You can only enter data in this field when you are creating a new VLAN.) The range of the VLAN ID is (1 to 4094).
• <b>Add</b>	To add a new VLAN Group with the specify VLAN ID. Once the Add button be pressed. The page will be redirect to have the VLAN member assign page.
• <b>Modify</b>	To modify an existence VLAN Group- adds new member ports or remove ports from the selected VLAN Group.
• <b>Delete</b>	Delete the selected VLAN Group.

### 4.5.1.1 Add a VLAN Group

The Gigabit Ethernet Switch supports up to 64 active VLAN groups and the range for the VLAN ID is **1-4094**.

1. To add a VLAN group, filed in the **VLAN ID** (from 1-4094) and please press “**Add**” button, the new VLAN Setup screen will pop out.
2. Checked the Member box to select the members for the VLAN group.
3. After setup completed, please press “**Apply**” to take affect.

As show in Figure 4-7 and Figure 4-8

Figure 4-7 Add a VLAN screen

VLAN ID: 2	
Port	Member
1	<input type="checkbox"/>
2	<input type="checkbox"/>
3	<input type="checkbox"/>
4	<input type="checkbox"/>
5	<input type="checkbox"/>
6	<input type="checkbox"/>
7	<input type="checkbox"/>
8	<input type="checkbox"/>

Figure 4-8 VLAN Member Setup screen

#### 4.5.1.2 Modify the VLAN Group Member

Once you want to modify the existence VLAN Group member or delete a existence VLAN Group. Refer to the following steps.

1. To modify the members of an existence VLAN Group, check the VLAN Group ID and press **“Modify”** button. The ID VLAN Setup screen will pop out.
2. To add/remove a port from specific VLAN group, just check/cancel the Member check Box and press **“Apply”** to take affect.
3. To delete an existence VLAN Group, check the VLAN Group ID and press **“Delete”** button.

As show in Figure 4-9 appears.

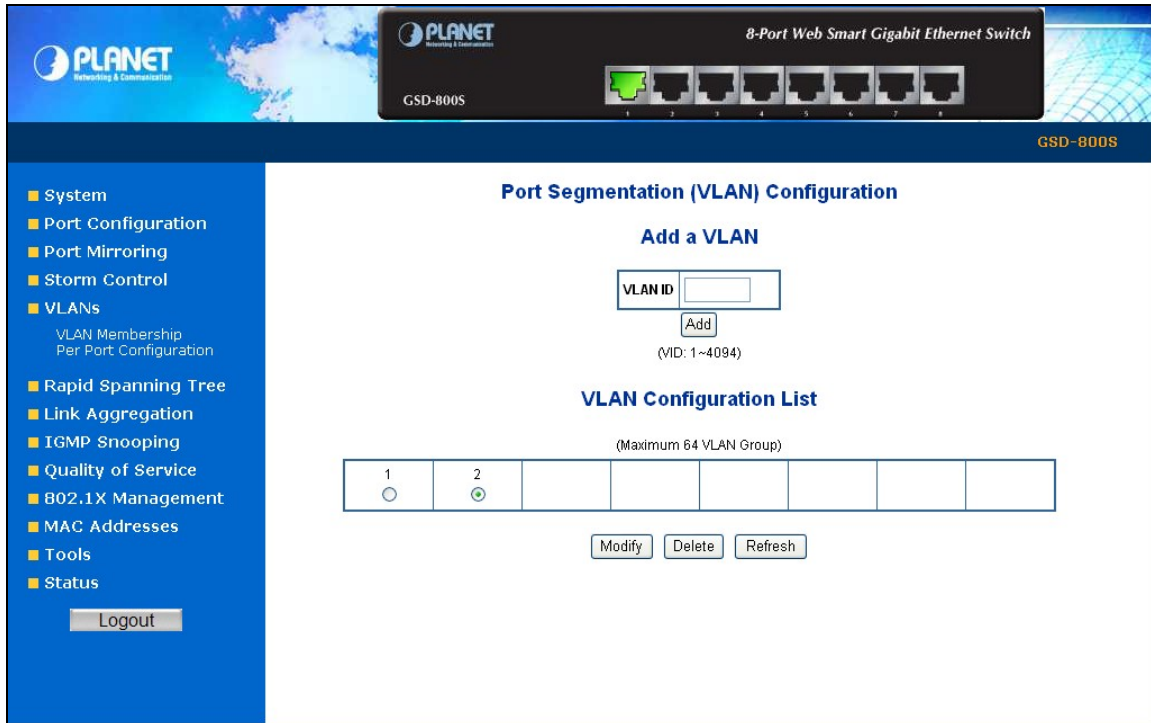

Figure 4-9 VLAN Group – member modify and delete VLAN Group screen

---

**Notice:** Once the VLAN Group be deleted, the Ports with the PVID set to this VLAN Group have to re-configure the PVID. Or the PVID will be set to “None”

---

### 4.5.2 Per Port Configuration

The VLAN per Port Configuration page contains fields for managing ports that are part of a VLAN. The port default VLAN ID (PVID) is configured on the VLAN Port Configuration page. All untagged packets arriving to the device are tagged by the ports PVID. The screen in Figure 4-10 appears.

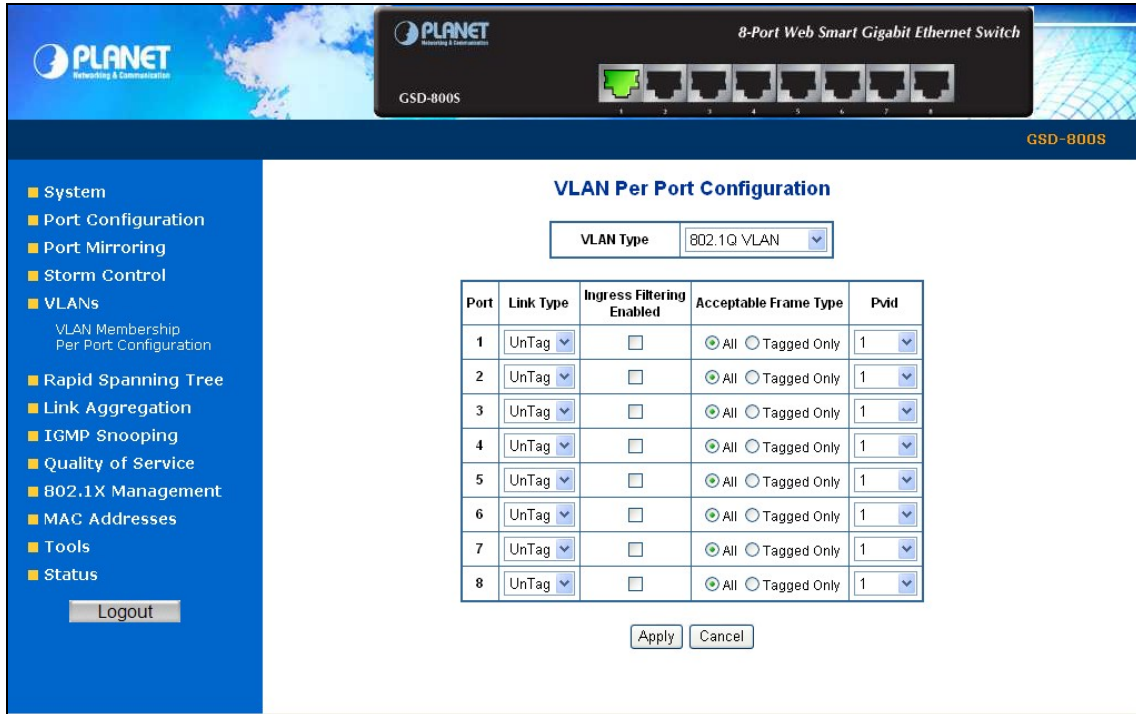

Figure 4-10 VLAN Port Configuration

The page includes the following fields:

- **VLAN Type**                      There're two VLAN mode support – 802.1Q VLAN and Port-Bas VLAN

  - **802.1Q** – Packets income will be tagged with VID as the PVID setting. All ports on the switch belong to default VLAN (VID 1).
  - **Port-Base** - Packets can only be broadcast among other members of the same VLAN group. Note all unselected ports are treated as belonging to the default system VLAN.

If port-based VLAN are enabled, then VLAN-tagging feature is ignored.
- **Port**                                      Select the physical interface for which you want to display or configure data.
- **Link Type**                              Allow 802.1Q Untagged or Tagged VLAN for selected port.

When adding a VLAN to selected port, it tells the switch whether to keep or remove the tag from a frame on egress.

  - **Untag**: outgoing frames without VLAN-Tagged.
  - **Tagged**: outgoing frames with VLAN-Tagged.
- **Ingress Filtering Enable**              **Enabled** - the frame is discarded if this port is not a member of the VLAN with which this frame is associated. In a tagged frame, the VLAN is identified by the VLAN ID in the tag. In an untagged frame, the VLAN is the Port VLAN ID specified for the port that received this frame.

**Disabled** - all frames are forwarded in accordance with the 802.1Q VLAN bridge specification. The factory default is disabled.

• **Acceptable Frame Types**

Specifies the types of frames that may be received on this port. The options are '**All**' and '**Tagged only**'.

- **All**- untagged frames or priority tagged frames received on this port are accepted and assigned the value of the Port VLAN ID for this port.
- **Tagged only** - untagged frames or priority tagged frames received on this port are discarded.

With either option, VLAN tagged frames are forwarded in accordance to the 802.1Q VLAN specification.

• **PVID**

Allow assign PVID for selected port. The range for the PVID is **1-4094**

The PVID will be inserted into all **untagged** frames entering the ingress port. The PVID must as same as the VLAN ID that the port belong to VLAN group, or the untagged traffic will be dropped.

---

### 4.5.3 VLAN setting example:

#### 4.5.3.1 Two separate 802.1Q VLAN

The diagram shows how the switch handle Tagged and Untagged traffic flow for two VLANs. VLAN Group 2 and VLAN Group 3 are separated VLAN. Each VLAN isolate network traffic so only members of the VLAN receive traffic from the same VLAN members. The screen in Figure 4-11 appears and Table 4-1 describes the port configuration of switch.

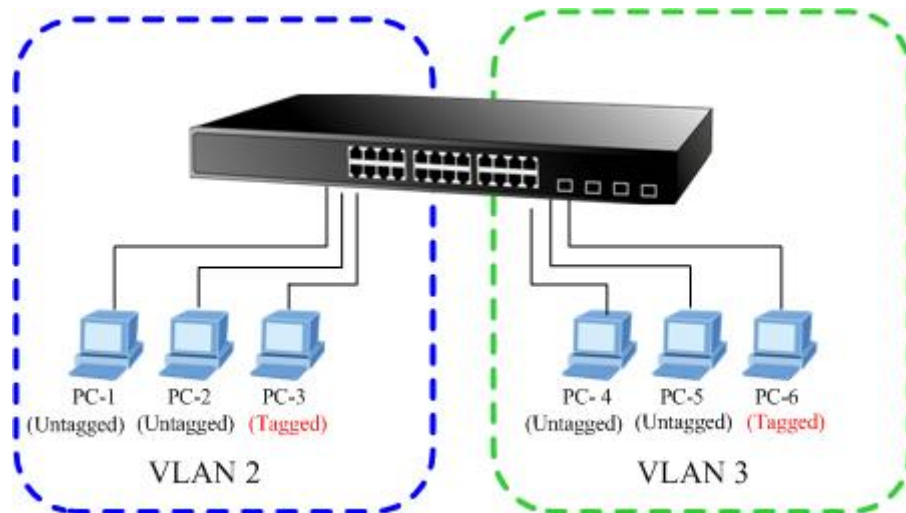

Figure 4-11 two separate VLAN diagram

VLAN Group	VID	Untagged Members	Tagged Members
VLAN Group 1	1	Port-7~Port-8	N/A
VLAN Group 2	2	Port-1,Port-2	Port-3
VLAN Group 3	3	Port-4,Port-5	Port-6

Table 4-1 VLAN and Port Configuration

The scenario described as follow:

#### ■ Untagged packet entering VLAN 2

1. While [PC-1] transmit an **untagged** packet enters **Port-1**, the switch will tag it with a **VLAN Tag=2**. [PC-2] and [PC-3] will received the packet through **Port-2** and **Port-3**.
2. [PC-4],[PC-5] and [PC-6] received no packet.
3. While the packet leaves **Port-2**, it will be stripped away it tag becoming an **untagged** packet.
4. While the packet leaves **Port-3**, it will keep as a **tagged** packet with **VLAN Tag=2**.

#### ■ Tagged packet entering VLAN 2

5. While [PC-3] transmit a **tagged** packet with **VLAN Tag=2** enters **Port-3**, [PC-1] and [PC-2] will received the packet through **Port-1** and **Port-2**.
6. While the packet leaves **Port-1** and **Port-2**, it will be stripped away it tag becoming an **untagged** packet.



■ **Untagged packet entering VLAN 3**

1. While [PC-4] transmit an **untagged** packet enters **Port-4**, the switch will tag it with a **VLAN Tag=3**. [PC-5] and [PC-6] will received the packet through **Port-5** and **Port-6**.
2. While the packet leaves **Port-5**, it will be stripped away it tag becoming an **untagged** packet.
3. While the packet leaves **Port-6**, it will keep as a **tagged** packet with **VLAN Tag=3**.

---

 **Notice:** At this example, VLAN Group 1 just set as default VLAN, but only focus on VLAN 2 and VLAN 3 traffic flow

---

**Setup steps**

**1. Create VLAN Group**

Set VALN Group 1 = default-VLAN with VID (VLAN ID)=1

Add two VLANs – VLAN 2 and VLAN 3

VLAN Group 2 with VID=2

VLAN Group 3 with VID=3

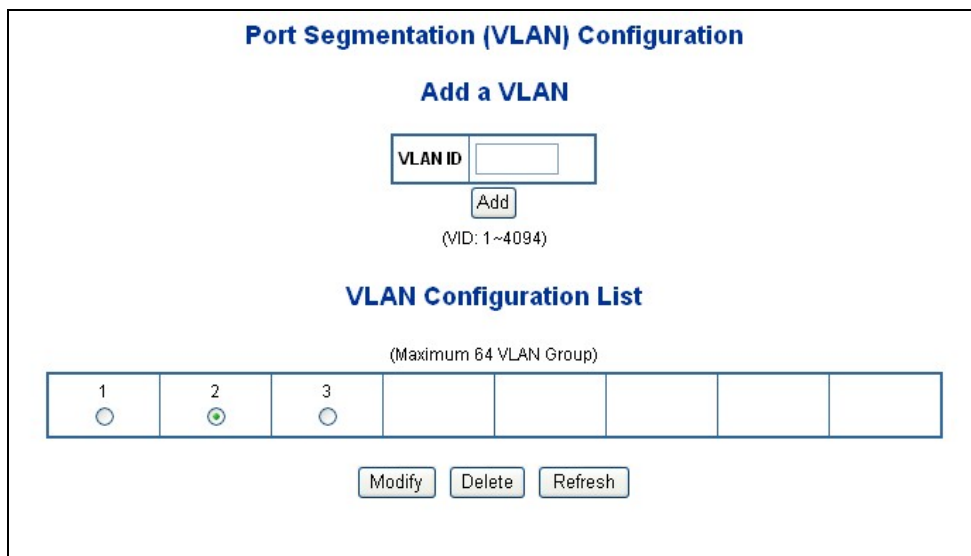

**Figure 4-12** Add new VLAN Group screen

**2. Assign VLAN Member :**

VLAN 2 : *Port-1,Port-2 and Port-3*

VLAN 3 : *Port-4, Port-5 and Port-6*

VLAN 1 : *All other ports – Port-7~Port-8*

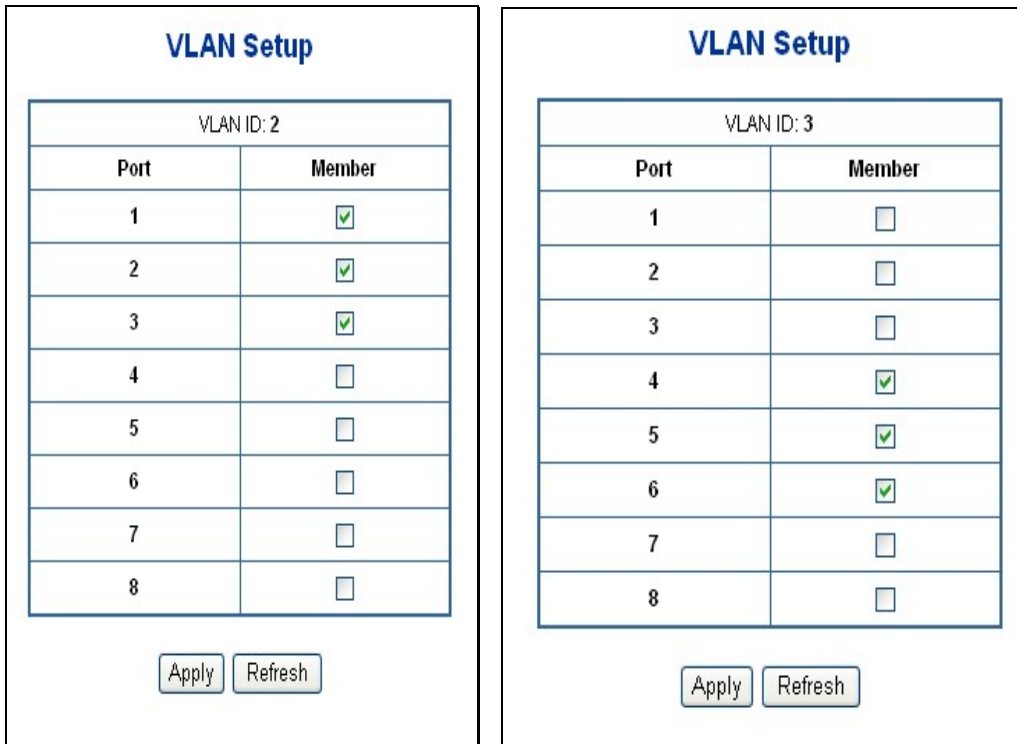

Figure 4-13 Assign VLAN members for VLAN 2 and VLAN 3

Remember to remove the Port 1 – Port 6 from VLAN 1 membership, since the Port 1 – Port 6 had been assigned to VLAN 2 and VLAN 3.

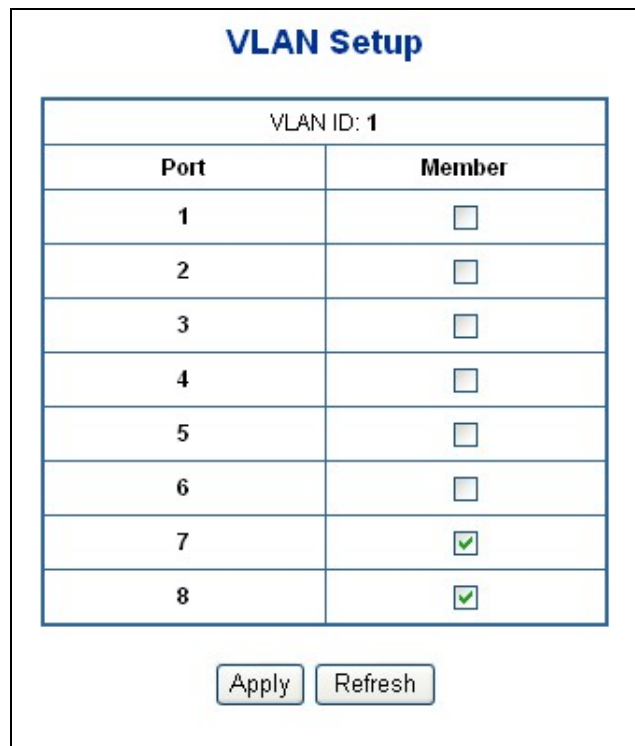

Figure 4-14 Remove specify ports from VLAN 1 member

**Notice:** It's import to remove the VLAN members from VLAN 1 configuration. Or the ports would become overlap setting. ( About the overlapped VLAN configuration, see next VLAN configure sample)

**3. Assign PVID for each port:**

Port-1,Port-2 and Port-3 : PVID=2

Port-4,Port-5 and Port-6 : PVID=3

Port-7~Port-8: PVID= 1

**4. Enable VLAN Tag for specific ports**

Link Type: *Port-3* (VLAN-2) and *Port-6* (VLAN-3)

The Per Port VLAN configuration in Figure 4-15 appears.

### VLAN Per Port Configuration

**VLAN Type**    802.1Q VLAN ▼

Port	Link Type	Ingress Filtering Enabled	Acceptable Frame Type	Pvid
1	UnTag ▼	<input type="checkbox"/>	<input checked="" type="radio"/> All <input type="radio"/> Tagged Only	2 ▼
2	UnTag ▼	<input type="checkbox"/>	<input checked="" type="radio"/> All <input type="radio"/> Tagged Only	2 ▼
3	Tag ▼	<input type="checkbox"/>	<input checked="" type="radio"/> All <input type="radio"/> Tagged Only	2 ▼
4	UnTag ▼	<input type="checkbox"/>	<input checked="" type="radio"/> All <input type="radio"/> Tagged Only	3 ▼
5	UnTag ▼	<input type="checkbox"/>	<input checked="" type="radio"/> All <input type="radio"/> Tagged Only	3 ▼
6	Tag ▼	<input type="checkbox"/>	<input checked="" type="radio"/> All <input type="radio"/> Tagged Only	3 ▼
7	UnTag ▼	<input type="checkbox"/>	<input checked="" type="radio"/> All <input type="radio"/> Tagged Only	1 ▼
8	UnTag ▼	<input type="checkbox"/>	<input checked="" type="radio"/> All <input type="radio"/> Tagged Only	1 ▼

**Figure 4-15** Port 1-Port 6 VLAN Configuration

#### 4.5.3.2 Two VLANs with overlap area

Follow the example of 4.5.3.1. There're two exist separate VLANs – VLAN 2 and VLAN 3, and the PCs of each VLANs are not able to access each other of different VLANs. But they all need to access with the same server. The screen in Figure 4-16 appear. This section will show you how to configure the port for the server – that could be accessed by both VLAN 2 and VLAN 3.

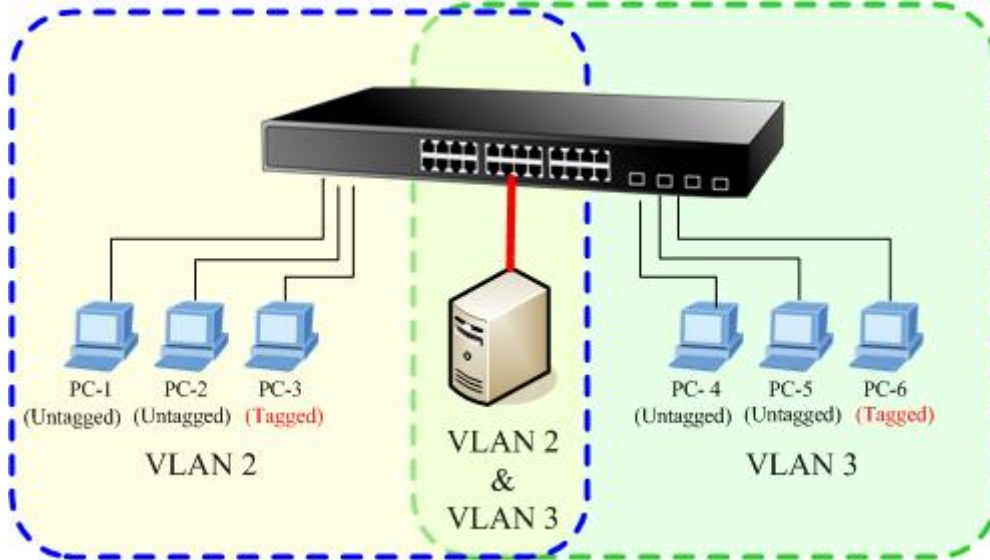

Figure 4-16 A Server connect to the VLAN overlap area

1. Specify **Port-7** on the device to connect to the server.
2. Assign **Port-7** to both **VLAN 2** and **VLAN 3** at the VLAN Member configuration page. The screen in Figure 4-17 appears.

### VLAN Setup

VLAN ID: 2	
Port	Member
1	<input checked="" type="checkbox"/>
2	<input checked="" type="checkbox"/>
3	<input checked="" type="checkbox"/>
4	<input type="checkbox"/>
5	<input type="checkbox"/>
6	<input type="checkbox"/>
7	<input checked="" type="checkbox"/>
8	<input type="checkbox"/>

Apply Refresh

### VLAN Setup

VLAN ID: 3	
Port	Member
1	<input type="checkbox"/>
2	<input type="checkbox"/>
3	<input type="checkbox"/>
4	<input checked="" type="checkbox"/>
5	<input checked="" type="checkbox"/>
6	<input checked="" type="checkbox"/>
7	<input checked="" type="checkbox"/>
8	<input type="checkbox"/>

Apply Refresh

Figure 4-17 VLAN overlap port setting

- Define a **VLAN 1** as a "Public Area" that overlapping with both **VLAN 2** members and **VLAN 3** members.

### VLAN Setup

VLAN ID: 1	
Port	Member
1	<input checked="" type="checkbox"/>
2	<input checked="" type="checkbox"/>
3	<input checked="" type="checkbox"/>
4	<input checked="" type="checkbox"/>
5	<input checked="" type="checkbox"/>
6	<input checked="" type="checkbox"/>
7	<input checked="" type="checkbox"/>
8	<input checked="" type="checkbox"/>

Figure 4-18 VLAN 1 – The public area member assign

- Setup **Port-7** with "PVID=1" at VLAN per Port Configuration page. The screen in Figure 4-19 appears.

### VLAN Per Port Configuration

VLAN Type: 802.1Q VLAN

Port	Link Type	Ingress Filtering Enabled	Acceptable Frame Type	Pvid
1	UnTag	<input type="checkbox"/>	<input checked="" type="radio"/> All <input type="radio"/> Tagged Only	2
2	UnTag	<input type="checkbox"/>	<input checked="" type="radio"/> All <input type="radio"/> Tagged Only	2
3	Tag	<input type="checkbox"/>	<input checked="" type="radio"/> All <input type="radio"/> Tagged Only	2
4	UnTag	<input type="checkbox"/>	<input checked="" type="radio"/> All <input type="radio"/> Tagged Only	3
5	UnTag	<input type="checkbox"/>	<input checked="" type="radio"/> All <input type="radio"/> Tagged Only	3
6	Tag	<input type="checkbox"/>	<input checked="" type="radio"/> All <input type="radio"/> Tagged Only	3
7	UnTag	<input type="checkbox"/>	<input checked="" type="radio"/> All <input type="radio"/> Tagged Only	1
8	UnTag	<input type="checkbox"/>	<input checked="" type="radio"/> All <input type="radio"/> Tagged Only	1

Figure 4-19 Setup Port-7 with PVID-1

That is, although the VLAN 2 members: Port-1 to Port-3 and VLAN 3 members: Port-4 to Port-6 also belong to VLAN 1. But with different PVID settings, packets from VLAN 2 or VLAN 3 is not able to access to the other VLAN.

#### 4.5.3.3 VLAN Trunking between two 802.1Q aware switch

The most cases are used for “Uplink” to other switches. VLANs are separated at different switches, but they need to access with other switches within the same VLAN group. The screen in Figure-20 appears.

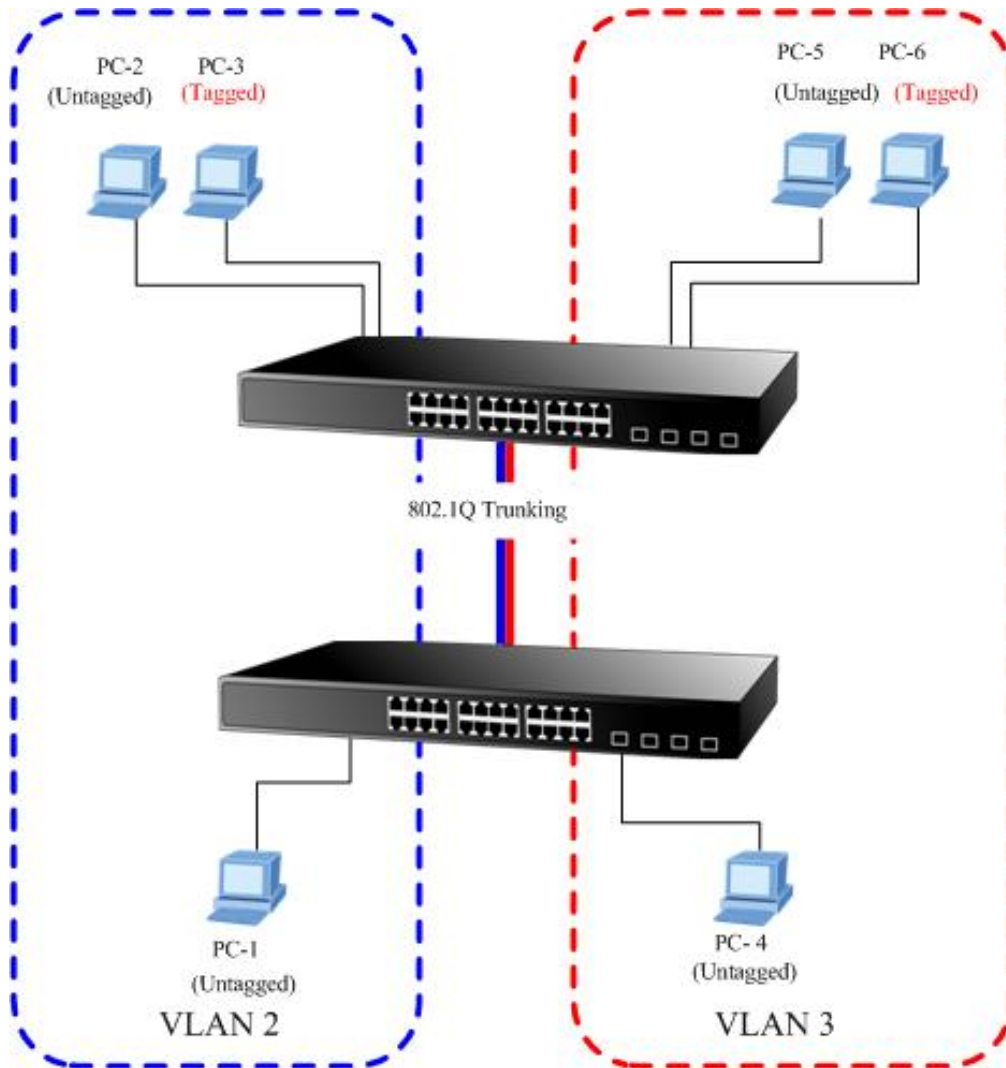

Figure 4-20 802.1Q Trunking with other VLAN aware device

About the VLAN ports connect to the hosts, please refer to 4.5.3.1 and 4.5.3.2 examples. The following steps will focus on the VLAN **Trunk port** configuration.

1. Specify **Port-8** to be the 802.1Q VLAN **Trunk port**, and the Trunking port must be a **Tagged** port while egress. The Port-8 configuration as the following screen in Figure 4-21.

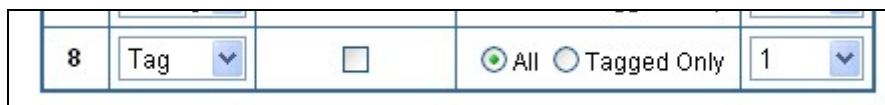

Figure 4-21 The configuration of VLAN Trunk port

2. Assign the VLAN Trunk Port to be the member of each VLAN – which wants to be aggregated. At this sample, add **Port-8** to be **VLAN 2** and **VLAN 3** member port.

### VLAN Setup

VLAN ID: 2	
Port	Member
1	<input checked="" type="checkbox"/>
2	<input checked="" type="checkbox"/>
3	<input checked="" type="checkbox"/>
4	<input type="checkbox"/>
5	<input type="checkbox"/>
6	<input type="checkbox"/>
7	<input type="checkbox"/>
8	<input checked="" type="checkbox"/>

### VLAN Setup

VLAN ID: 3	
Port	Member
1	<input type="checkbox"/>
2	<input type="checkbox"/>
3	<input type="checkbox"/>
4	<input checked="" type="checkbox"/>
5	<input checked="" type="checkbox"/>
6	<input checked="" type="checkbox"/>
7	<input type="checkbox"/>
8	<input checked="" type="checkbox"/>

**Figure 4-22** Add VLAN Trunk port to each VLAN

3. Repeat Step 1 and 2, setup the VLAN Trunk port at the partner switch.
4. To add more VLANs to join the VLAN trunk, repeat Step 2 to assign the Trunk port to the VLANs.

## 4.6 Rapid Spanning Tree

**Spanning Tree Protocol (STP)** provides tree topography for any arrangement of bridges. STP also provides one path between end stations on a network, eliminating loops.

**Rapid Spanning Tree Protocol (RSTP)** - While Classic Spanning Tree guarantees preventing L2 forwarding loops in a general network topology, convergence can take up to 30-60 seconds. The convergence time is considered too long for many applications. When network topology allows, faster convergence may be possible. The **Rapid Spanning Tree Protocol (RSTP)** detects and uses of network topologies that provide faster convergence of the spanning tree, without creating forwarding loops.

The devices support the following Spanning Tree protocols:

- **Compatible -- Spanning Tree Protocol (STP)**: Provides a single path between end stations, avoiding and eliminating loops.
- **Normal -- Rapid Spanning Tree Protocol (RSTP)** : Detects and uses of network topologies that provide faster spanning tree convergence, without creating forwarding loops.

---

 **Notice:** The Gigabit Ethernet Switch implement the Rapid Spanning Protocol as the default spanning tree protocol. While select “**Compatibles**” mode, the system use the RSTP (802.1w) to compatible and co work with another STP (802.1d)’s BPDU control packets.

---

This page is to enable/disable the Spanning Tree protocol. The switch support IEEE 802.1d Spanning Tree (STP), IEEE 802.1w Rapid Spanning Tree (RSTP). The screen in Figure 4-23 appears.

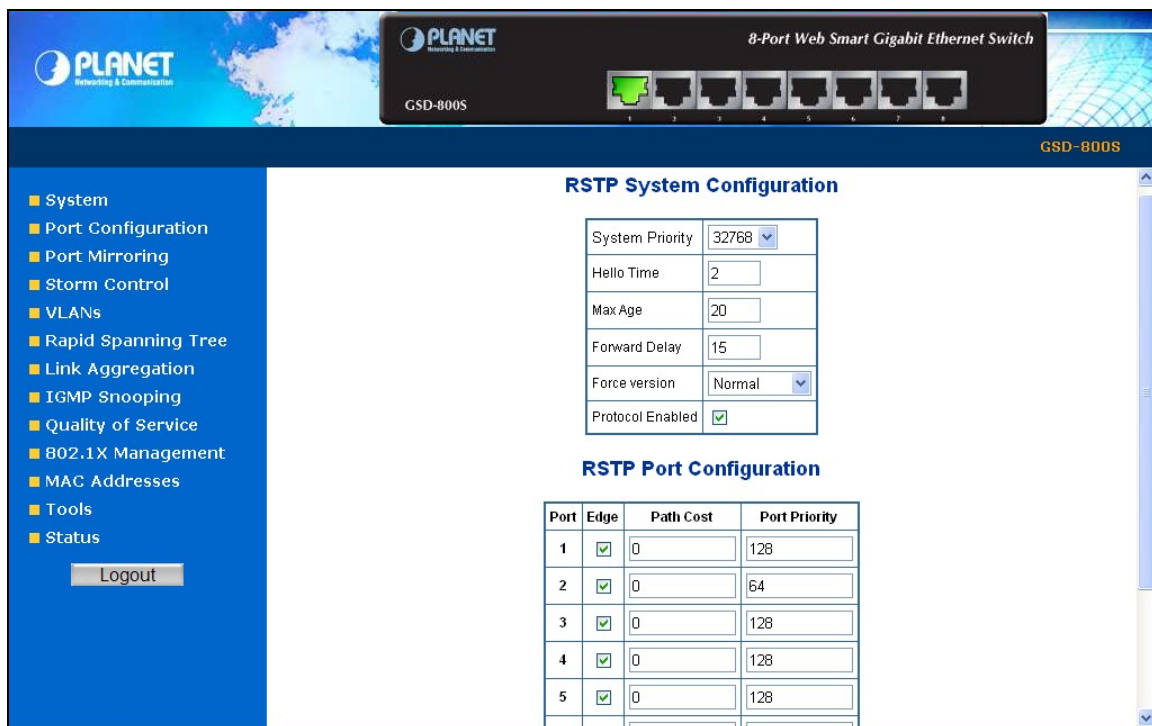

The screenshot shows the web management interface for a Planet GSD-800S switch. The main content area is titled "RSTP System Configuration" and contains the following settings:

- System Priority: 32768
- Hello Time: 2
- Max Age: 20
- Forward Delay: 15
- Force version: Normal
- Protocol Enabled:

Below this is the "RSTP Port Configuration" section, which includes a table with the following data:

Port	Edge	Path Cost	Port Priority
1	<input checked="" type="checkbox"/>	0	128
2	<input checked="" type="checkbox"/>	0	64
3	<input checked="" type="checkbox"/>	0	128
4	<input checked="" type="checkbox"/>	0	128
5	<input checked="" type="checkbox"/>	0	128

Figure 4-23 Rappid Spanning Tree System/Port Configuration



## 4.6.1 RSTP System Configuration

The "RSTP System Configuration" table allows configuring the spanning tree parameters.

### RSTP System Configuration

RSTP Enabled	Enable ▼
System Priority	32768 ▼
Hello Time	2 (1~10)
Max Age	20 (6~40)
Forward Delay	15 (4~30)
Force version	Normal ▼

Figure 4-24 RSTP System Configuration

The page includes the following fields:

- 
- **System Priority** Specifies the bridge priority value. When switches or bridges are running STP, each is assigned a priority. After exchanging BPDUs, the switch with the lowest priority value becomes the Root Bridge. The bridge priority value is provided in increments of 4096 (4K increments). For example, 0, 4096, 8192, etc.

The default value is **32768**.
  - **Hello Time** Specifies the device Hello Time. The Hello Time indicates the amount of time in seconds a root bridge waits between configuration messages.

Value Range: 1-10.

The default is **2** seconds.
  - **Max Age** Specifies the device Maximum Age Time. The Maximum Age Time indicates the amount of time in seconds a bridge waits before sending configuration messages.

Value Range: 6-40.

The default max age is **20** seconds.
  - **Forward Delay** Specifies the device forward delay time. The Forward Delay Time indicates the amount of time in seconds a bridge remains in a listening and learning state before forwarding packets.

Value Range : 4-30.

The default is **15** seconds.
  - **Force version** Specifies the Force Protocol Version parameter for the switch. The options are Normal and Compatible

**Normal – Rapid STP (802.1w)**: Detects and uses of network topologies that provide faster spanning tree convergence, without creating forwarding loops.

**Compatible – Classis STP (802.1d)**: Provides a single path between end
-

stations, avoiding and eliminating loops.



**Notice:**

- **Max Age** - The value lies between 6 and 40, with the value being less than or equal to "(2 \* Bridge Forward Delay) - 1" and greater than or equal to "2 \* ( Bridge Hello Time +1)". The default value is 20.
- **Hello Time** - The value being less than or equal to "(Bridge Max Age / 2) - 1". The default hello time value is 2.
- **Forward Delay**- Bridge Forward Delay must be greater or equal to "(Bridge Max Age / 2) + 1". The time range is from 4 seconds to 30 seconds. The default value is 15.

### 4.6.2 RSTP Port Configuration

The RSTP Port Configuration page contains fields for assigning RSTP properties to individual ports. The screen in Figure 4-25 appears.

<b>RSTP Port Configuration</b>			
Port	Edge	Path Cost	Port Priority
1	<input checked="" type="checkbox"/>	0	128
2	<input checked="" type="checkbox"/>	0	64
3	<input checked="" type="checkbox"/>	0	128
4	<input checked="" type="checkbox"/>	0	128
5	<input checked="" type="checkbox"/>	0	128
6	<input checked="" type="checkbox"/>	0	128
7	<input checked="" type="checkbox"/>	0	128
8	<input checked="" type="checkbox"/>	0	128

**Figure 4-25** RSTP Port Configuration

The page includes the following fields:

- **Port** Indicate port 1 to port 24.
- **Edge** Indicates whether the port is enabled as an edge port.  
  
Edge port cannot create loops, but it loses edge port status if a topology change creates a potential for a loop. An edge port normally should not receive BPDU packets. If a BPDU packet is received it automatically loses edge port status.
- **Path Cost** The port contribution to the root path cost. The path cost is adjusted to a higher or lower value, and is used to forward traffic when a path being rerouted.  
  
Value Range : 1-20000000.  
  
Default Path Cost -- The default path cost of the port is automatically set by the port speed and the default path cost method. The default values for path costs are:  
  
- Ethernet – 2000000.

- Fast Ethernet - 200000.
- Gigabit Ethernet - 20000.

### 4.6.3 RSTP Status

The RSTP Status page display the current STP bridge , roor bridge and per port stp status.

To access **RSTP Status** screen and perform the following procedure:

1. Click Status -> RSTP Status
2. The “RSTP VLAN Bridge Overview” and “RSTP Port Status” screen is displayed as in Figure 4-26.

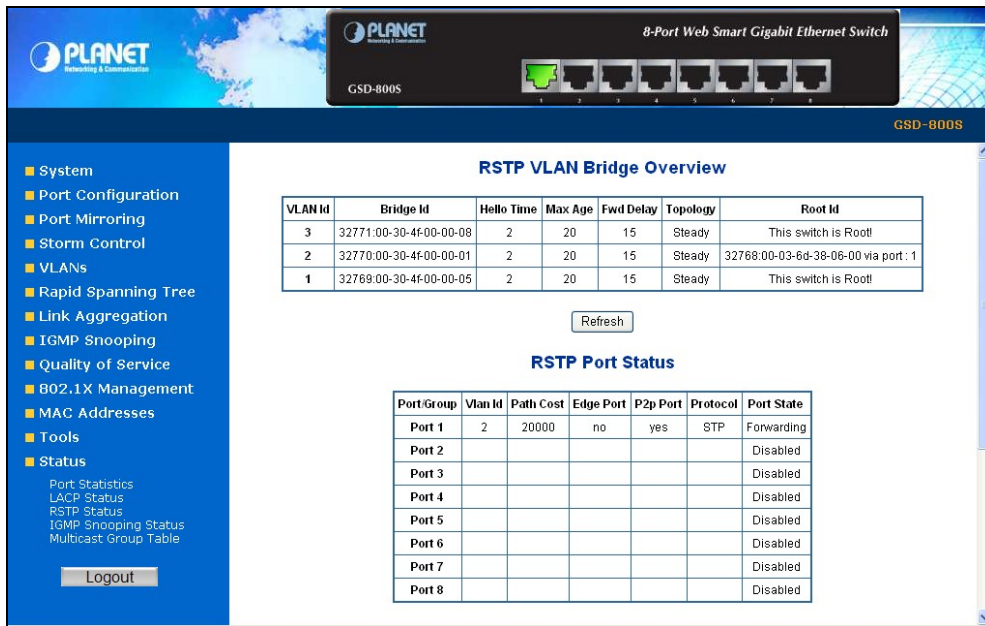

Figure 4-26 RSTP Status screen

#### ■ RSTP VLAN Bridge Overview

The information of the RSTP Root shows in the Bridge overview table. The screen in Figure 4-27 appears.

VLAN Id	Bridge Id	Hello Time	Max Age	Fwd Delay	Topology	Root Id
3	32771:00-30-4f00-00-08	2	20	15	Steady	This switch is Root!
2	32770:00-30-4f00-00-01	2	20	15	Steady	32768:00-03-6d-38-06-00 via port : 1
1	32769:00-30-4f00-00-05	2	20	15	Steady	This switch is Root!

Figure 4-27 RSTP Status screen

The page includes the following fields:

- **VLAN Id** Identifies VLANs associated with the Rapid Spanning Tree.
- **Bridge IDd** Identifies the Bridge priority and MAC address.
- **Hello Time** Minimum time between transmissions of Configuration BPDUs.

- **Max Age** Path Cost to the Designated Root for the spanning tree.
- **Forward Delay** Derived value of the Root Port Bridge Forward Delay parameter.
- **Topology** Specifies the Topology change status of the current operation. If no topology change happened, the table show "**Steady**".
- **Root Id** Identifies the Root Bridge priority and MAC address.

■ **RSTP Port Status**

The information of the RSTP Per Port and Trunk group shows in the RSTP Port Status table. The screen in Figure 4-28 appears.

<b>RSTP Port Status</b>						
<b>Port/Group</b>	<b>Vlan Id</b>	<b>Path Cost</b>	<b>Edge Port</b>	<b>P2p Port</b>	<b>Protocol</b>	<b>Port State</b>
<b>Port 1</b>	2	20000	no	yes	STP	Forwarding
<b>Port 2</b>						Disabled
<b>Port 3</b>						Disabled
<b>Port 4</b>						Disabled
<b>Port 5</b>						Disabled
<b>Port 6</b>						Disabled
<b>Port 7</b>						Disabled
<b>Port 8</b>						Disabled

**Figure 4-28** RSTP Status screen

The page includes the following fields:

- **Port/Group** Port or Link Aggregation group on which Rapid STP is enabled
- **VLAN Id** Port or Link Aggregation interfaces associated with VLANs associated with the Rapid Spanning Tree.
- **Path Cost** Cost of the port participating in the RSTP topology. Ports with a lower cost are less likely to be blocked if STP detects loops.
- **Edge Port** Indicates whether the port is enabled as an edge port. It takes the value "**Yes**" or "**No**".
- **P2p Port** The Point-to-Point operating state. This is the actual device port link type.
- **Protocol** Indicates the current spanning protocol on the ports.
- **Port State** The current port STP state. If enabled, the port state determines what forwarding action is taken on traffic. Possible port states are:
  - **Disabled** -- The port link is currently down.
  - **Blocking** -- The port is currently blocked and cannot be used to forward traffic

or learn MAC addresses. Blocking is displayed when Classic STP is enabled.

- **Listening** -- The port is currently in the listening mode. The port cannot forward traffic nor can it learn MAC addresses.
  - **Learning** -- The port is currently in the learning mode. The port cannot forward traffic however it can learn new MAC addresses.
  - **Forwarding** -- The port is currently in the forwarding mode. The port can forward traffic and learn new MAC addresses.
- 
- 

---

 **Notice:** A port transitions from one state to another as follows:

- From initialization (switch boot) to blocking.
  - From blocking to listening or to disabled.
  - From listening to learning or to disabled.
  - From learning to forwarding or to disabled.
  - From forwarding to disabled.
  - From disabled to blocking.
-

## 4.7 Link Aggregation

Port Aggregation optimizes port usage by linking a group of ports together to form a single Link Aggregated Groups (LAGs). Port Aggregation multiplies the bandwidth between the devices, increases port flexibility, and provides link redundancy.

Each LAG is composed of ports of the same speed, set to full-duplex operations. Ports in a LAG, can be of different media types (UTP/Fiber, or different fiber types), provided they operate at the same speed.

Aggregated Links can be assigned manually (**Port Trunk**) or automatically by enabling Link Aggregation Control Protocol (**LACP**) on the relevant links.

Aggregated Links are treated by the system as a single logical port. Specifically, the Aggregated Link has similar port attributes to a non-aggregated port, including auto-negotiation, speed, Duplex setting, etc.

The device supports the following Aggregation links :

- **Static LAGs (Port Trunk)** – Force aggregated selected ports to be a trunk group.
- **Link Aggregation Control Protocol (LACP)** LAGs - LACP LAG negotiate Aggregated Port links with other LACP ports located on a different device. If the other device ports are also LACP ports, the devices establish a LAG between them.

### 4.7.1 Port Trunk

This function provides to cascade two Switch devices with a double bandwidth.

- 4 Trunk Group per system, up to 8 ports per Trunk Group.

The Port Trunking configuration screen in Figure 4-29 appears.

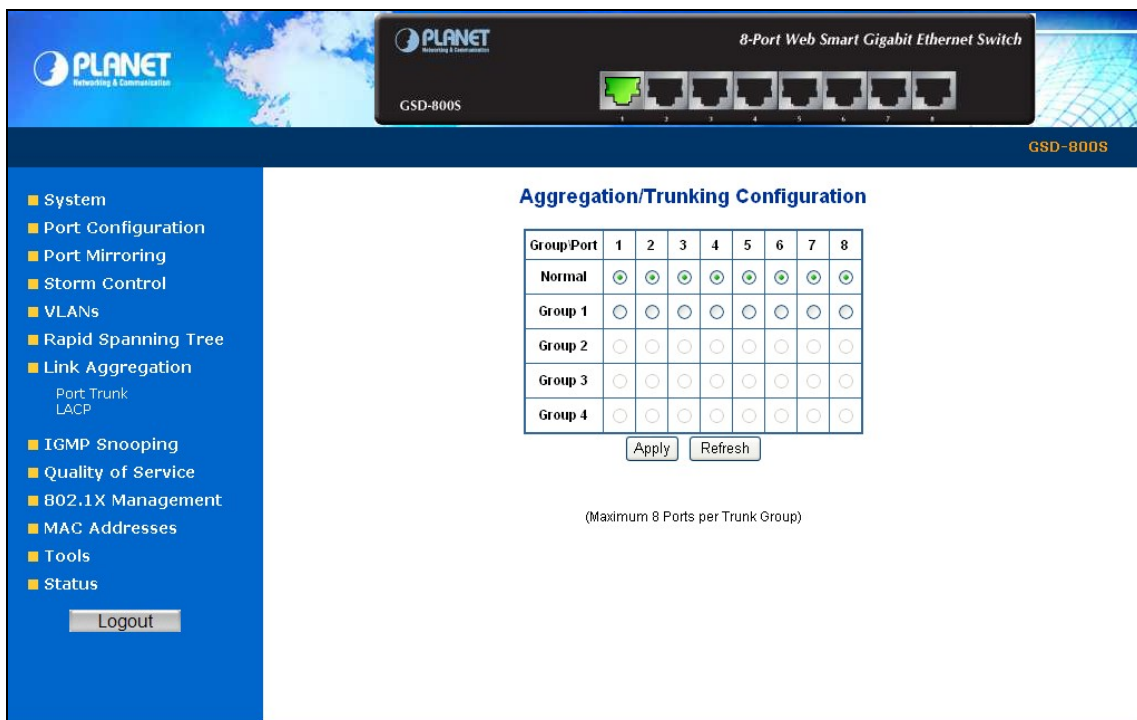

Figure 4-29 Aggregation/Trunking Configuration screen

The page includes the following fields:

- 
- **Port** Indicate port 1 to port 8.
  - **Normal** While a port is checked as “Normal”, the port is not joining to any Static Trunk Group.
  - **Group** Specify the Joined Trunk Group. There're maximum 4 trunk groups per system. With different switch model, the maximum number of ports are as follow:  
  
A port can be assigned to only one Trunk Group.
- 

### 4.7.2 LACP

Link Aggregation Control Protocol (LACP) - LACP LAG negotiate Aggregated Port links with other LACP ports located on a different device. If the other device ports are also LACP ports, the devices establish a LAG between them.

The LACP Port Configuration page contains fields for assigning LACP properties to individual ports. The screen in Figure 4-30 appears.

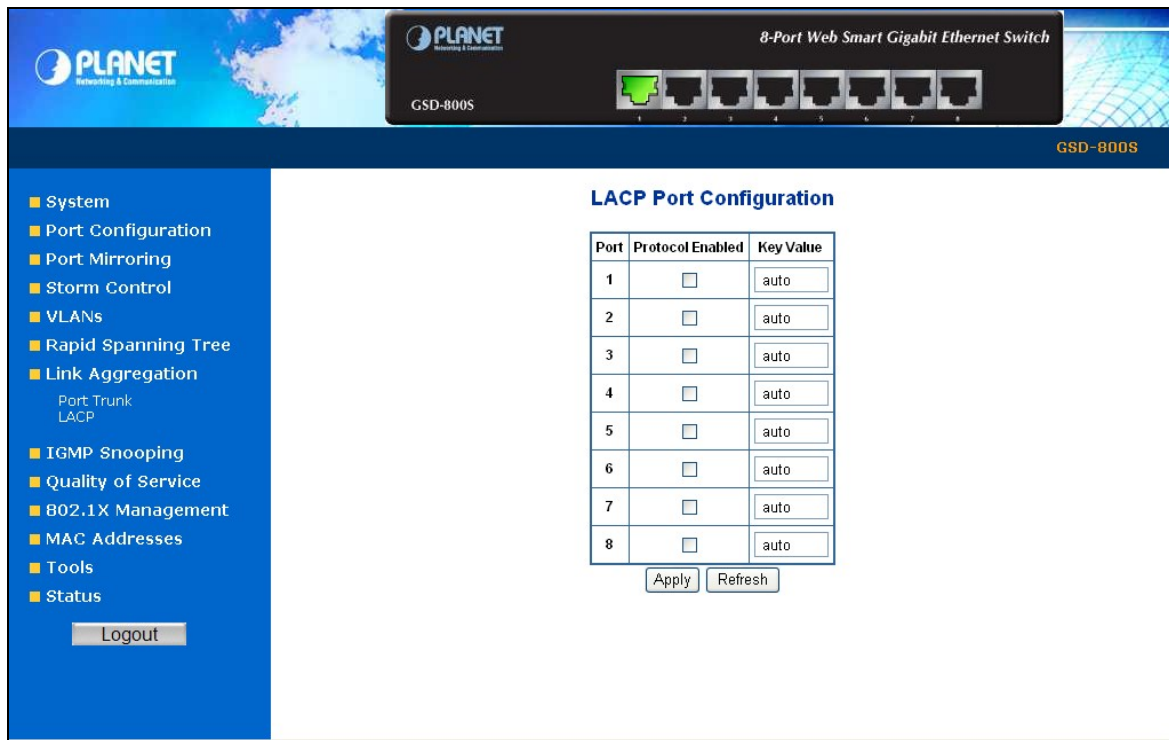

Figure 4-30 LACP Port Configuration

The page includes the following fields:

---

---

• <b>Port</b>	Indicate port 1 to port 8.
• <b>Protocol Enable</b>	To Enable or disable the LCAP protocol on a selected port. Once the LCAP protocol be enabled, the system will start transmit the LCAP control packets and exchange with another LCAP aware switch. If the linked switch didn't support LCAP, then the aggregated link will not be established.
• <b>Key Value</b>	The Key Value will be filed in the LCAP control packets. Ports with same key value will be set to the same LCAP Group. If two ports are set with different key value, they will become two different LCAP groups. The key value will also be the identify ID to the linked LCAP switch.  The default setting is "Auto"

---

---



**Notice:**

When using a port link aggregation, note that:

- The ports that can be assigned to the same link aggregation have certain other restrictions (see below).
  - Ports can only be assigned to one link aggregation.
  - The ports at both ends of a connection must be configured as link aggregation ports.
  - None of the ports in a link aggregation can be configured as a mirror source port or a mirror target port.
  - All of the ports in a link aggregation have to be treated as a whole when moved from/to, added or deleted from a VLAN.
  - The Spanning Tree Protocol will treat all the ports in a link aggregation as a whole.
  - Disconnect all link aggregation port cables or disable the link aggregation ports before removing a port link aggregation to avoid creating a data loop.
-



### 4.7.3 LACP Status

The LACP Status page display the current LACP aggregation Groups and LACP Port status.

To open **LACP Status** screen perform the following:

1. Click Status -> LACP Status.
2. The "LACP Aggregation Overview" and "LACP Port Status" screen is displayed as in Figure 4-31.



Figure 4-31 LACP Status

#### ■ LACP Aggregation Overview Table

The LACP Aggregation Overview Table lists the active LACP ports and mapped Group. It also indicates the Partner Port number of the other LACP aware switches. The screen in Figure 4-32 appears.

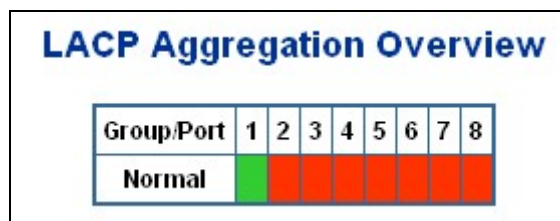

Figure 4-32 LACP Aggregation Overview

The page includes the following fields:

• <b>Group / Port</b>	Indicate port 1 to port 8.
• <b>Normal</b>	While a port is checked as "Normal", the port is not joining to any LACP Trunk Group.
• <b>Group #</b>	The Linked LACP aggregation group. The Group ID is the first port ID of the LACP group member. Ex. Port 7 and Port 8 as a LACP group-> Group 7.

The Color and ID legend

0	Down	Port link down.
0	Blocked	Port Blocked by RSTP. Number is Partner port number if other switch has LACP enabled.
0	Learning	Port Learning by RSTP.
0	Forwarding	Port link up and forwarding frames.
0	Forwarding	Port link up and forwarding by RSTP. Number is <b>Partner port number</b> if other switch has LACP enabled.

■ LACP Port Status Table

The LACP Port Status Table lists the active LACP ports and the Partner Port number with the operational Port Key value. The screen in Figure 4-33 appears.

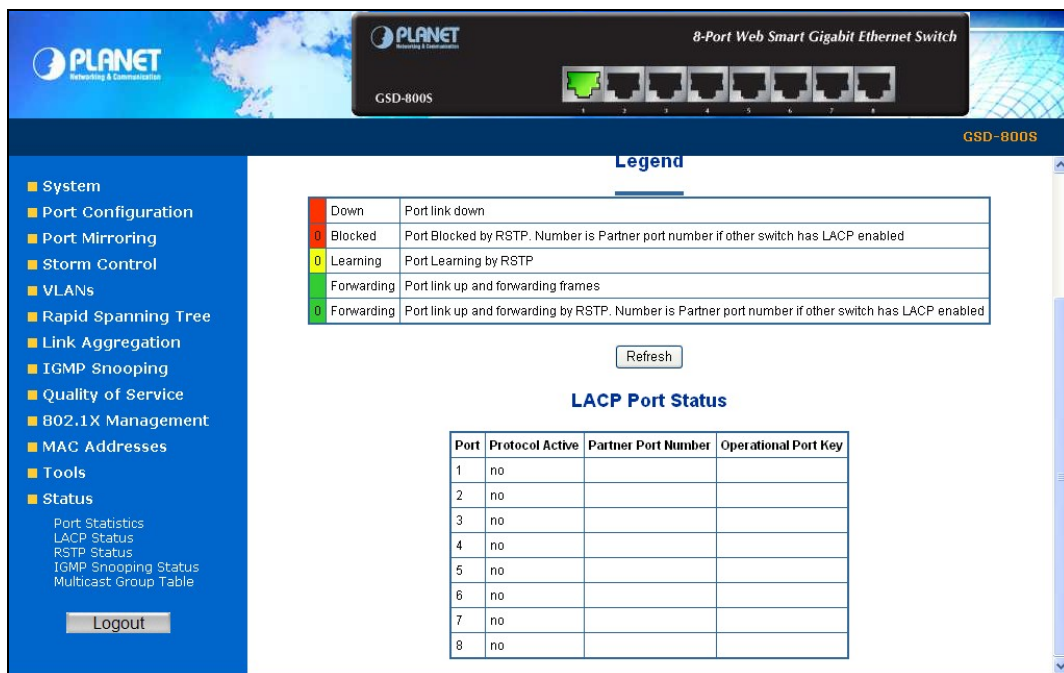

Figure-4-33 LACP Port Status

The page includes the following fields:

- **Port** Indicate port 1 to port 8.
- **Protocol Active** Indicate the LCAP protocol is enable or not on the port.  
**Yes-** LACP is enabled and active on the port.  
**No-** LACP is not enabled, or LACP is enabled but not active on the port.  
 It's usually depends on the partner switch is LACP enabled or not.
- **Partner Port Number** The port number/ID of the linked partner switch- if other switch has LACP enabled.  
 Ex. Row of Port 7with Partner Port Number value=15.  
 The Port 7 of the switch is connecting to the Port 15 of the partner switch directly – both of the two switches are with LACP enabled.
- **Operational Port Key** The current operational key value of the partner port. Within the same LACP group, the port key value should be the same with the other LACP active ports.

## 4.8 IGMP Snooping

The Internet Group Management Protocol (IGMP) lets host and routers share information about multicast groups memberships. IGMP snooping is a switch feature that monitors the exchange of IGMP messages and copies them to the CPU for feature processing. The overall purpose of IGMP Snooping is to limit the forwarding of multicast frames to only ports that are a member of the multicast group.

### 4.8.1 IGMP Snooping Configuration

The IGMP Configuration page let the administrator to configure the parameters for IGMP Snooping, which is used to build forwarding lists for multicast traffic. The screen in Figure 4-34 appears.

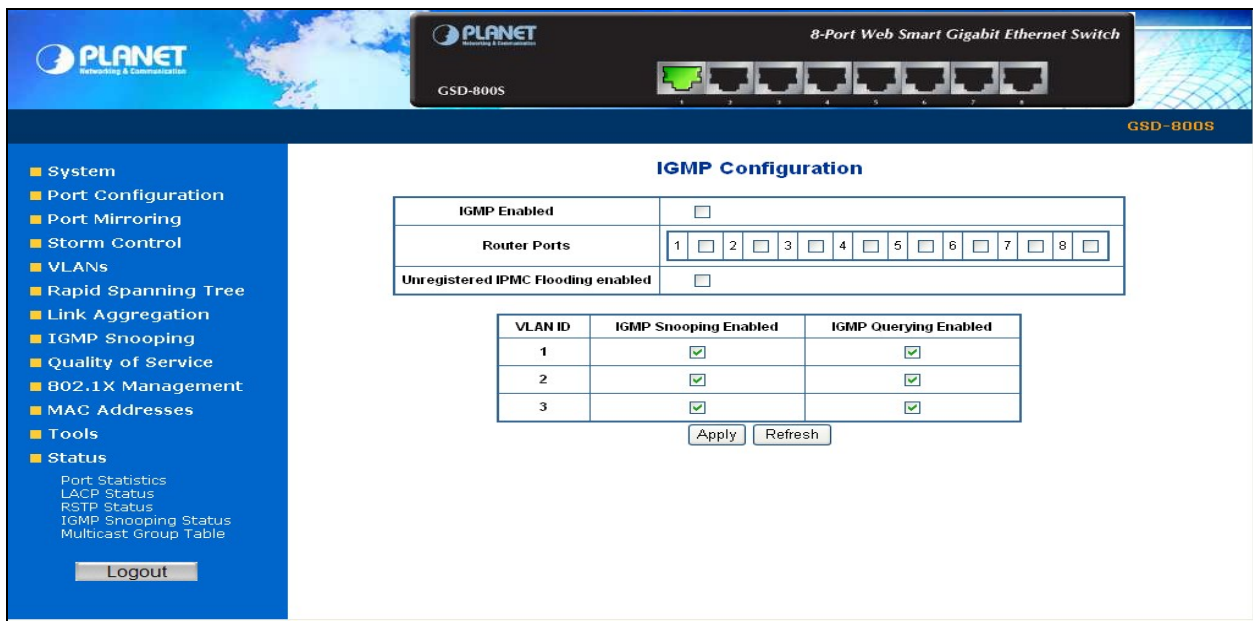

Figure 4-34 IGMP Snooping Configuration and Status

The page includes the following fields:

- 
- **IGMP Enable**                      Enables or disables IGMP global function on the device. **Disabled** is the default value.
  - **Router Ports**                      The Router Ports check box fields for attaching ports to a device that is attached to a neighboring Multicast router/switch. Once IGMP Snooping is enabled, Multicast packets are forwarded to the appropriate port .
  - **Unregistered IPMC Flooding Enable**                      The function is to set “Enable” or “Disable” to allow the unregistered IP Multicast Group streams to flood to all ports of this switch. The unregistered IP Multicast means that the received Multicast Group address not listed in the Multicast Group Table of the switch. **Enabled** is the default value. The switch forwards all the multicast steams to all the host or linked switch.
  - **VLAN ID**                              Identifies a VLAN and contains information about the Multicast group configuration. Add a new VLAN group and the Table will add the VLAN entry automatically.
  - **IGMP Snooping Enabled**                      Enables or disables IGMP snooping on the VLAN. Ports be assign to the VLAN will be applied to filter the Multicast stream. **Enabled** is the default value.
  - **IGMP Querying**                      Enables or disables IGMP Query mode on the VLAN. The Query mode is used to
-

**Enabled**

periodically check the multicast group for members that are no longer active. In the case where there is more than one multicast router on a sub network, one router is elected as the 'queried'. This router then keeps track of the membership of the multicast groups that have active members. The information received from IGMP is then used to determine if multicast packets should be forwarded to a given sub network or not. The router can check, using IGMP, to see if there is at least one member of a multicast group on a given subnet work. If there are no members on a sub network, packets will not be forwarded to that sub network.

**Enabled** is the default value.



**Notice:**

Add a new VLAN group, the VLAN ID will be added to the table automatically with both "IGMP Snooping Enabled" and "IGMP Querying Enabled".

### 4.8.2 IGMP Snooping Status

The IGMP Snooping page display the current IGMP Status and the statistics of received Query / report packets.

To open **IGMP Status** screen perform the following:

1. Click Status -> IGMP Snooping Status
2. The "IGMP Status" screen is displayed as in Figure 4-35.

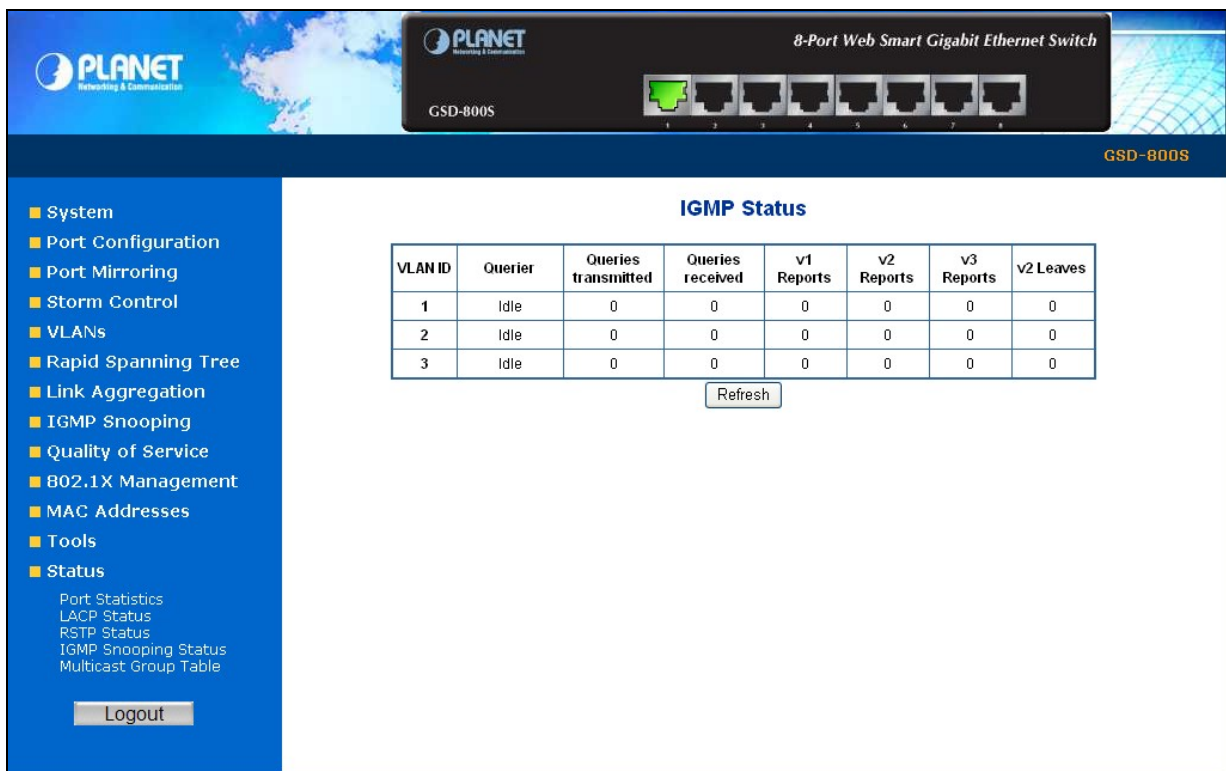

Figure 4-35 IGMP Snooping Status

The page includes the following fields:

• <b>VLAN ID</b>	Identifies a VLAN and contains information about the Multicast group configuration.
• <b>Querier</b>	<p>Display the current status of IGMP Querier on the device.</p> <p><b>Active</b> – The IGMP Query function had been enabled on the device and played as a main Querier within a subnet domain. Within a network domain, there will be only one IGMP Querier. While two or more Querier exist, only one Querier operation by election. The Querier will transmit a IGMP Query packet about every 125 secs.</p> <p><b>Idle</b> – The IGMP Querier function had be enabled but might be at the initiation status, or there're already other Querier exist.</p>
• <b>Queries transmitted</b>	Statistics of IGMP Query packets transmitted from the VLAN. Only the "IGMP Querying Enabled" be checked, the counter is active.
• <b>Queries received</b>	Statistics of IGMP Query packets received at the VLAN –from another switches or routers.
• <b>V1 Reports</b>	<p>Statistics of IGMP V1 report packets received at the VLAN.</p> <p>(Packets with content type = <b>0x12</b> ; The Membership Report (version 1))</p>
• <b>V2 Reports</b>	<p>Statistics of IGMP V2 report packets received at the VLAN.</p> <p>(Packets with content type = <b>0x16</b> ; The Membership Report (version 2)</p>
• <b>V3 Reports</b>	Statistics of IGMP V3 report packets received at the VLAN.
• <b>V2 Leaves</b>	<p>Statistics of IGMP V2 leave packets received at the VLAN.</p> <p>(Packets with content type = <b>0x17</b> ; Leave a Group (version 2)</p>

### 4.8.3 Multicast Group Table

The Multicast Group page displays the ports attached to the Multicast service group in the Ports tables. The Port a tables also reflect the manner in which the port joined the Multicast group. Ports can be added either to existing groups or to new Multicast service groups. The Bridge Multicast Group page permits new Multicast service groups to be created. The Bridge Multicast Group page also assigns ports to a specific Multicast service address group.

To open **Multicast Group Tables** screen perform the folling:

1. Click Status -> Multicast Group Table.
2. The Multicast Group Table screen is displayed as in Figure 4-36.

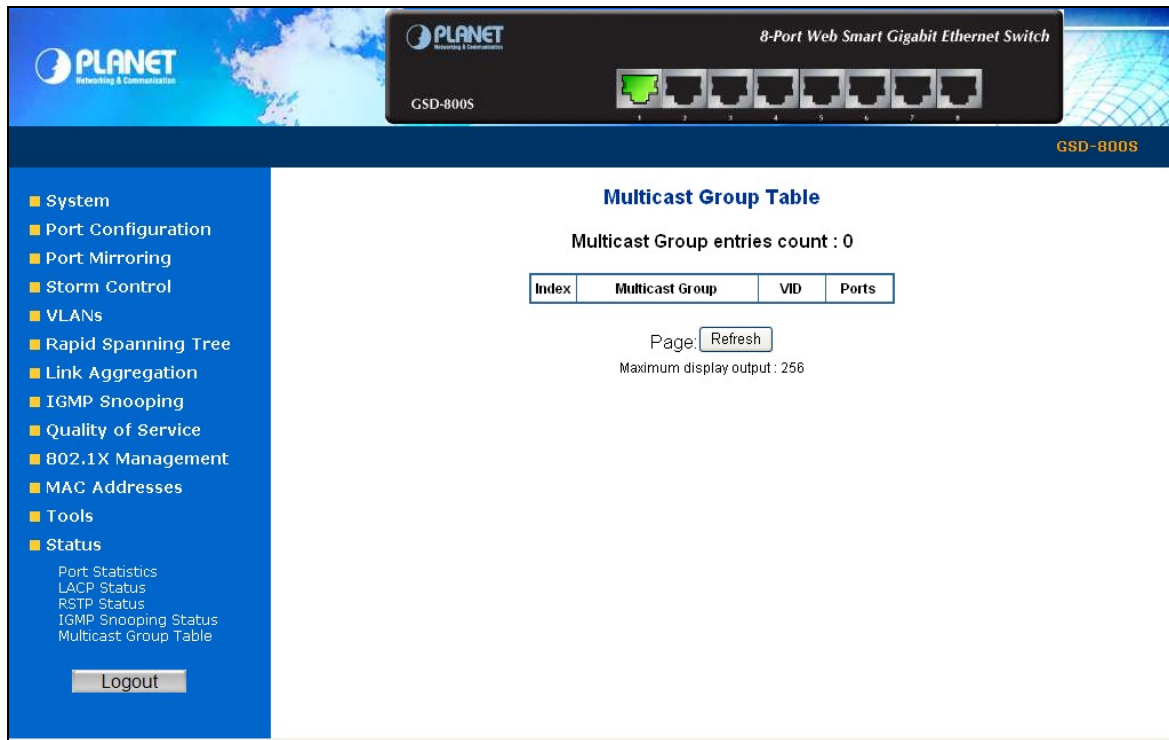

Figure 4-36 The Multicast Group Table screen

The page includes the following fields:

<ul style="list-style-type: none"> <li>• <b>Multicast Group entries Count</b></li> <li>• <b>Multicast Group</b></li> <li>• <b>VID</b></li> <li>• <b>Ports</b></li> </ul>	<p>The total count of the current Multicast Group entries of the switch.</p> <p>Identifies the Multicast group MAC address/IP address</p> <p>Identifies a VLAN and contains information about the Multicast group address.</p> <p>Identifies assigned ports to a specific Multicast service address group- By received Join or leave packets.</p>
--	---

## 4.9 Quality of Service

Quality of Service (QoS) is an advanced traffic prioritization feature that allows you to establish control over network traffic. QoS enables you to assign various grades of network service to different types of traffic, such as multi-media, video, protocol-specific, time critical, and file-backup traffic.

QoS reduces bandwidth limitations, delay, loss, and jitter. It also provides increased reliability for delivery of your data and allows you to prioritize certain applications across your network. You can define exactly how you want the switch to treat selected applications and types of traffic.

You can use QoS on your system to:

- Classifying traffic based on packet attributes.
- Assigning priorities to traffic (for example, to set higher priorities to time-critical or business-critical applications).
- Applying security policy through traffic filtering.
- Provide predictable throughput for multimedia applications such as video conferencing or voice over IP by minimizing delay and jitter.
- Improve performance for specific types of traffic and preserve performance as the amount of traffic grows.
- Reduce the need to constantly add bandwidth to the network.
- Manage network congestion.

The **QoS Configuration** page contains fields for enabling or disabling QoS. In addition, the 802.1p mode or DSCP mode can be selected. Both the two mode rely on predefined fields within the packet to determine the output queue.

- **Queue Mode** - This indicates that traffic scheduling for the selected queue is based strictly or WRR ( Weight Round Robin ) on the queue priority.
- **QoS Disabled** - Disables managing network traffic using Quality of Service.
- **802.1p Mode** –The output queue assignment is determined by the IEEE802.1p VLAN priority tag.
- **DSCP Mode** - The output queue assignment is determined by the DSCP field.

---

 **Notice:** The current version of GSD-800S/GSD-802S/GSD-802PS support QoS **Strict** mode only. The strict mode is to specifies if traffic scheduling is based strictly on the queue priority.

---

The QoS Configuration page in Figure 4-37 appears.



Figure 4-37 QoS Configuration screen

### 4.9.1 802.1p QoS Mode

QoS settings allow customization of packet priority in order to facilitate delivery of data traffic that might be affected by latency problems. The IEEE 802.1p Priority specification uses 8 priority levels to classify data packets. The screen in Figure 4-38 and Figure 4-39 appears.

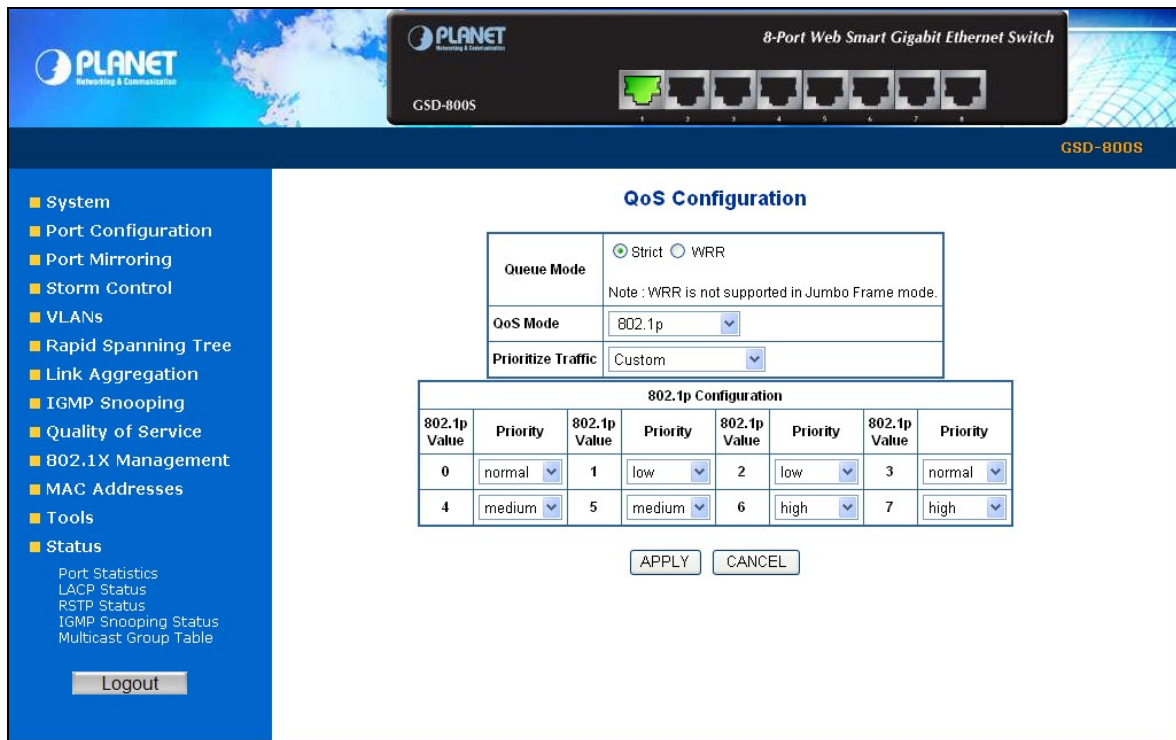

Figure 4-38 802.1p QoS Configuration screen



<b>QoS Mode</b>		802.1p	
<b>Prioritize Traffic</b>		Custom	
		<ul style="list-style-type: none"> <li>Custom</li> <li>All Low Priority</li> <li>All Normal Priority</li> <li>All Medium Priority</li> <li>All High Priority</li> </ul>	
<b>Priority</b>	<b>802.1p Value</b>		
normal	1	normal	2

Figure 4-39 Prioritize Traffic screen

The page includes the following fields:

- 
- **Prioritize Traffic**      The draw menu allows customization of 802.1p to Traffic classifiers. Total 5 selections for the Prioritize Traffic.

    - **Custom** – Manual mapping the 802.1p priority to the 4-level queues. Setup at the next table.
    - **All Low Priority**      - mapping all 802.1p tagged packets to **Queue 0**
    - **All Normal Priority**    - mapping all 802.1p tagged packets to **Queue 1**
    - **All Medium Priority**    - mapping all 802.1p tagged packets to **Queue 2**
    - **All High Priority**      - mapping all 802.1p tagged packets to **Queue 3**
  
  - **802.1p Value**            Specifies the CoS priority tag values, where zero is the lowest and 7 is the highest.
  
  - **Priority**                      The traffic forwarding queue to which the CoS priority is mapped. Four traffic priority queues are supported as follow :

    - **Low**      = **Queue 0**
    - **Normal** = **Queue 1**
    - **Medium** = **Queue 2**
    - **High**    = **Queue 3**
-

### 4.9.2 DSCP QoS Mode

**DiffServ Code Point (DSCP)** – is the traffic prioritization bits within an IP header that are encoded by certain applications and/or devices to indicate the level of service required by the packet across a network.

The **DSCP Configuration** page provides fields for defining output queue to specific DSCP fields. Select the QoS mode to DSCP, the DSCP to queue mapping configuration page appears, as the Figure 4-40 shows.

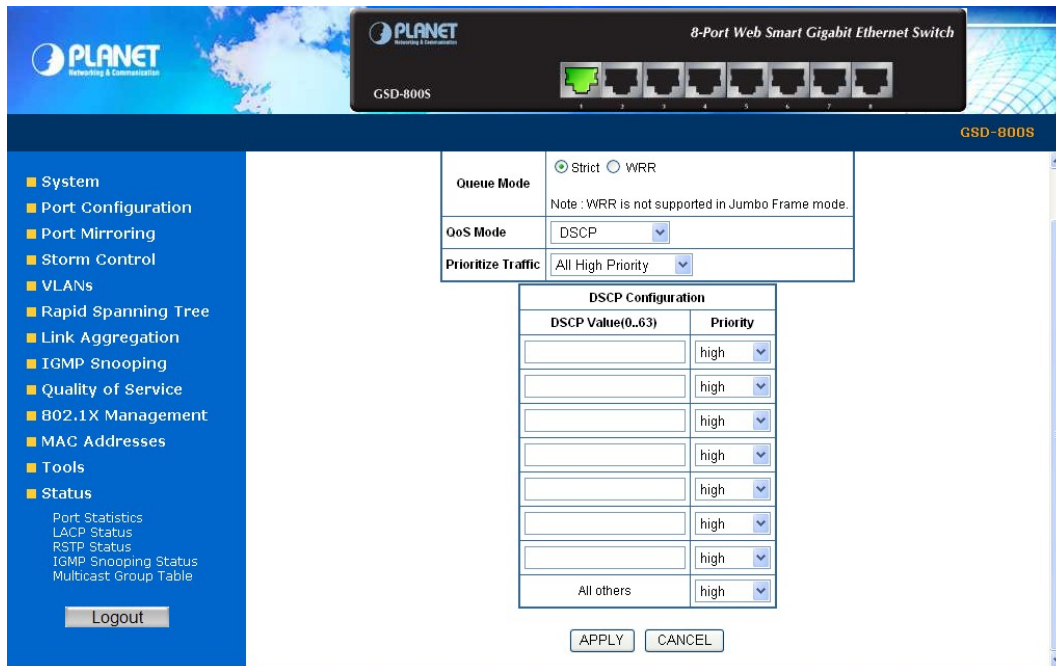

Figure 4-40 DSCP QoS Configuration screen

The page includes the following fields:

<ul style="list-style-type: none"> <li>• <b>Prioritize Traffic</b></li> </ul>	<p>The draw menu allows customization of DSCP to Traffic classifiers. Total 5 selections for the Prioritize Traffic.</p> <ul style="list-style-type: none"> <li>• <b>Custom</b> – Manual mapping the DSCP to the 4-level queues. Setup at the next table.</li> <li>• <b>All Low Priority</b> - mapping all IP DCSP header packets to <b>Queue 0</b></li> <li>• <b>All Normal Priority</b> - mapping all IP DCSP header packets to <b>Queue 1</b></li> <li>• <b>All Medium Priority</b> - mapping all IP DCSP header packets to <b>Queue 2</b></li> <li>• <b>All High Priority</b> - mapping all IP DCSP header packets to <b>Queue 3</b></li> </ul>
<ul style="list-style-type: none"> <li>• <b>DSCP Value ( 0..63)</b></li> </ul>	<p>The values of the IP DSCP header field within the incoming packet.</p>
<ul style="list-style-type: none"> <li>• <b>Priority</b></li> </ul>	<p>The traffic forwarding queue to which the DSCP is mapped. Four traffic priority queues are supported.</p> <p>The queue to which packets with the specific DSCP value is assigned. The values are low,Normal,Medium and High.</p> <ul style="list-style-type: none"> <li>• <b>Low</b> = <b>Queue 0</b></li> <li>• <b>Normal</b> = <b>Queue 1</b></li> <li>• <b>Medium</b> = <b>Queue 2</b></li> <li>• <b>High</b> = <b>Queue 3</b></li> </ul>

## 4.10 802.1X Management

The PLANET Gigabit Ethernet Switch supports IEEE 802.1X Port-based network access control and RADIUS server authentication to enhance the host link more security. An 802.1X Infrastructure is composed of three major components: Authenticator, Authentication server, and Supplicant.

**Authentication server – (RADIUS Server):** An entity that provides an authentication service to an authenticator. This service determines, from the credentials provided by the supplicant, whether the supplicant is authorized to access the services provided by the authenticator.

**Authenticator-(GSD-800S):** An entity at one end of a point-to-point LAN segment that facilitates authentication of the entity attached to the other end of that link.

**Supplicant-(A Host Client):** An entity at one end of a point-to-point LAN segment that is being authenticated by an authenticator attached to the other end of that link.

The instructions are divided into three parts:

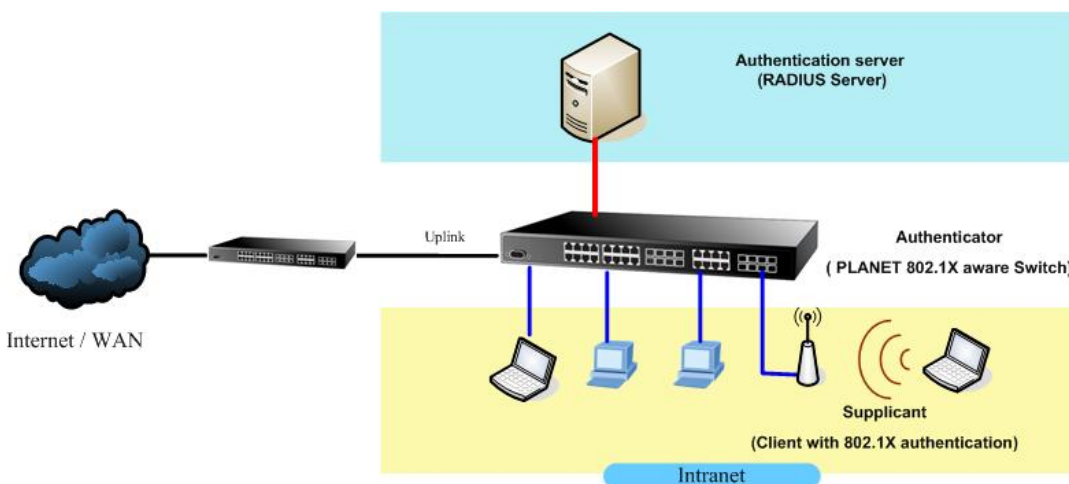

The above graph shows the network topology of the solution we are going to introduce. As illustrated, a group of clients is trying to build a network with Switch in order to have access to both Internet and Intranet. With 802.1X authentication, each of these clients would have to be authenticated by RADIUS server. If the client is authorized, Switch would be notified to open up a communication port to be used for the client. There are 2 Extensive Authentication Protocol (EAP) methods supported: (1) MD5 and (2) TLS.

MD5 authentication is simply a validation of existing user account and password that is stored in a database of RADIUS server. Therefore, clients will be prompted for account/password validation to build the link. TLS authentication is a more complicated authentication, which is using certificate that is issued by RADIUS server for authentication. TLS authentication is a more secure authentication, since not only RADIUS server authenticates the client, but also the client can validate RADIUS server by the certificate that it issues. The TLS authentication request from clients and reply by Radius Server and Switch can be briefed as follows:

1. The client sends an EAP start message to Web-Smart Switch.
2. Web-Smart Switch replies with an EAP Request ID message.
3. The client sends its Network Access Identifier (NAI) – its user name – to Web-Smart Switch in an EAP Respond message.
4. Web-Smart Switch forwards the NAI to the RADIUS server with a RADIUS Access Request message.
5. The RADIUS server responds to the client with its digital certificate.
6. The client validates the digital certificate, and replies its own digital certificate to the RADIUS server.
7. The RADIUS server validates client's digital certificate.

8. The client and RADIUS server derive encryption keys.
9. The RADIUS server sends Web-Smart Switch a RADIUS ACCEPT message.
10. Web-Smart Switch sends the client an EAP Success message along with the broadcast key and key length.

This section is to control the access of the switch, includes the user access and management control. The 802.1X Management page contains links to the following topics:

- RADIUS Server Configuration
- Port Access Control

### 4.10.1 RADIUS Server Configuration

This page is to configure the RADIUS server connection features. The screen in Figure 4-41 and Figure 4-42 appears.

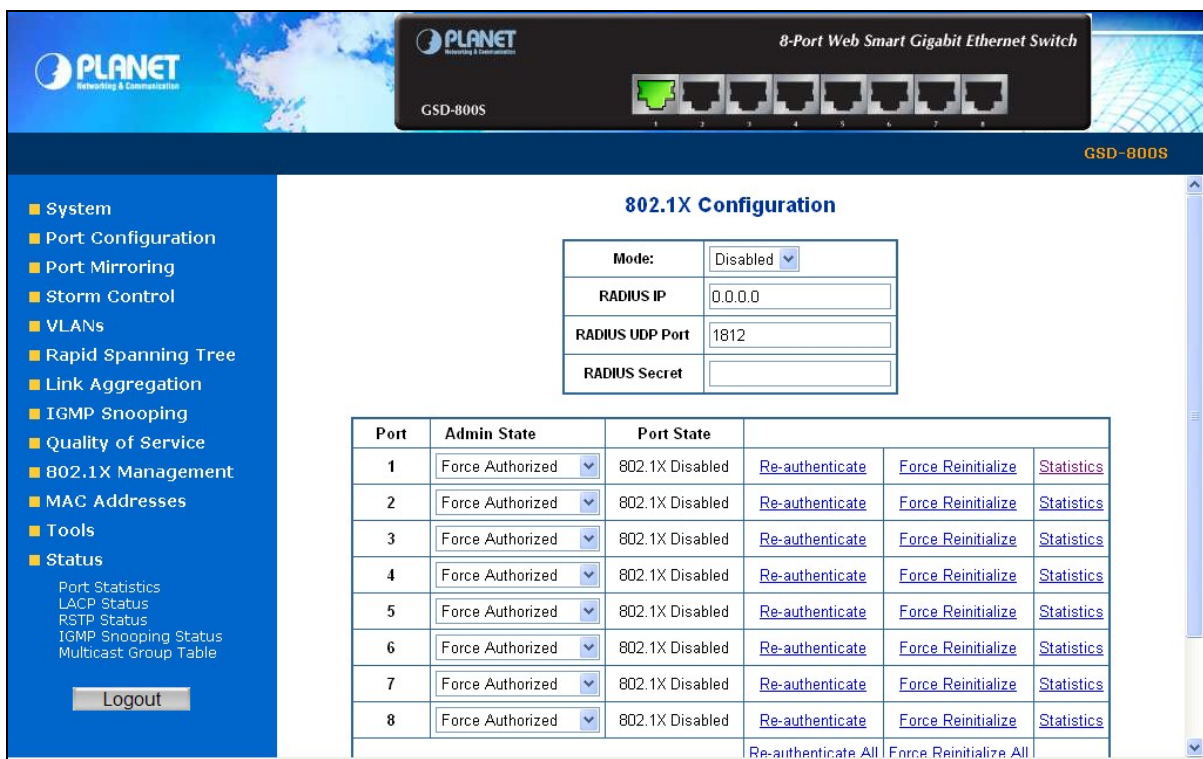

Figure 4-41 802.1X Configuration screen

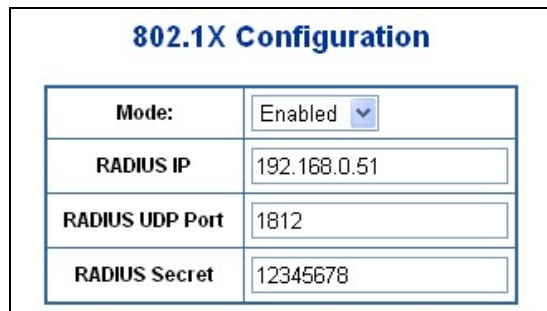
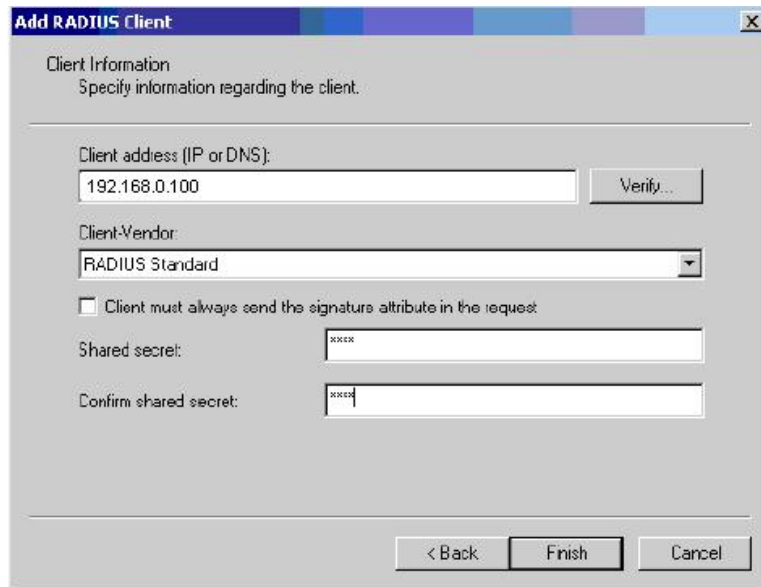

Figure 4-42 RADIUS Server configuration table screen

The RADIUS Server configuration table includes the following fields:

• <b>Mode</b>	To Enable/Disable the port access control administrative mode.  This selector lists the two options for administrative mode: enable and disable. The default value is <b>disabled</b> .
• <b>RADIUS Server IP</b>	The IP address of the RADIUS server being added.
• <b>RADIUS UDP Port</b>	The UDP port used by this server. The valid range is 0 - 65535. The default UDP Port No. is <b>1812</b>
• <b>RADIUS Secret</b>	Indicates if the shared secret for this server has been configured.

Setup the RADIUS server and assign the client IP address to the Web-Smart switch. In this case, field in the default IP Address of the Web-Smart switch with 192.168.0.100. And also make sure the shared secret key is as same as the one you had set at the switch RADIUS server – 12345678 at this case.



**Figure 4-43** RADIUS Server configuration

### 4.10.2 Port Access Control

This table is to configure the per port network access control setting. By drawing and select the menu bar to define the port control type. The screen in Figure 4-44 and Figure 4-45 appears.

Port	Admin State	Port State			
1	Force Authorized	802.1X Disabled	<a href="#">Re-authenticate</a>	<a href="#">Force Reinitialize</a>	<a href="#">Statistics</a>
2	Force Authorized	802.1X Disabled	<a href="#">Re-authenticate</a>	<a href="#">Force Reinitialize</a>	<a href="#">Statistics</a>
3	Force Authorized	802.1X Disabled	<a href="#">Re-authenticate</a>	<a href="#">Force Reinitialize</a>	<a href="#">Statistics</a>
4	Force Authorized	802.1X Disabled	<a href="#">Re-authenticate</a>	<a href="#">Force Reinitialize</a>	<a href="#">Statistics</a>
5	Force Authorized	802.1X Disabled	<a href="#">Re-authenticate</a>	<a href="#">Force Reinitialize</a>	<a href="#">Statistics</a>
6	Force Authorized	802.1X Disabled	<a href="#">Re-authenticate</a>	<a href="#">Force Reinitialize</a>	<a href="#">Statistics</a>
7	Force Authorized	802.1X Disabled	<a href="#">Re-authenticate</a>	<a href="#">Force Reinitialize</a>	<a href="#">Statistics</a>
8	Force Authorized	802.1X Disabled	<a href="#">Re-authenticate</a>	<a href="#">Force Reinitialize</a>	<a href="#">Statistics</a>
			<a href="#">Re-authenticate All</a>	<a href="#">Force Reinitialize All</a>	

Figure 4-44 Per Port network access control configure table

Port	Admin State
1	Force Authorized
2	Auto
3	Force Unauthorized

Figure 4-45 802.1X Network access control mode selection

The Network Access Control port configuration table includes the following fields:

- **Port** Selects the port to be configured. When the selection is changed, a screen refresh will occur causing all fields to be updated for the newly selected port.
- **Admin State** This selector lists the options for control mode. The control mode is only set if the link status of the port is link up. The options are:

  - **Auto:** The authenticator PAE sets the controlled port mode to reflect the outcome of the authentication exchanges between the supplicant, authenticator, and the authentication server.
  - **Force authorized:** The authenticator PAE unconditionally sets the controlled port to be authorized.
  - **Force unauthorized:** The authenticator port access entity (PAE) unconditionally sets the controlled port to unauthorized.
- **Port State** This field indicates the configured control mode for the port.
- **Re-authenticate** This button begins the re-authentication sequence on the selected port. This button is only selectable if the control mode is 'auto'. If the button is not selectable, it will be grayed out. Once this button is pressed, the action is immediate. It is not required to press the Submit button for the action to occur.

- **Force Reinitialize** This button begins the re-initialization sequence on the selected port. This button is only selectable if the control mode is 'auto'. If the button is not selectable, it will be grayed out. Once this button is pressed, the action is immediate. It is not required to press the Submit button for the action to occur.
- **Statistics** This button redirect to the "802.1X Statistics" page on the selected port.
- **Re-authenticate All** This button begins the re-authentication sequence on the all ports.
- **Force Reinitialize All** This button begins the re-initialization sequence on all ports.

At the bottom of this page, click "**Parameter**" button will redirect to the "**802.1X parameter**" configure page. The screen in Figure 4-46 appears.

### 802.1X Parameters

Reauthentication Enabled	<input type="checkbox"/> Enabled
Reauthentication Period [1-3600 seconds]	<input style="width: 60px;" type="text" value="3600"/>
EAP timeout [1 - 255 seconds]	<input style="width: 60px;" type="text" value="30"/>

**Figure 4-46** 802.1X Parameter configuration screen

The 802.1X Parameters table includes the following fields:

- 
- **Reauthentication Enabled** This select field allows the user to enable or disable reauthentication of the supplicant for the specified port. If "Enabled" be checked, reauthentication will occur. Otherwise, reauthentication will not be allowed. Changing the selection will not change the configuration until the Apply button is pressed.  
The default value is **not "Enabled"**
  - **Reauthentication Period [1-3600 seconds]** This input field allows the user to enter the reauthentication period for the selected port. The reauthentication period is the value, in seconds, of the timer used by the authenticator state machine on this port to determine when reauthentication of the supplicant takes place. The reauthentication period must be a value in the range of 1 and 65535. Changing the value will not change the configuration until the Apply button is pressed.  
The default value is **3600**.
  - **EAP Timeout [1-255 seconds]** This input field allows the user to enter the EAP timeout for the selected port. The EAP timeout is the value, in seconds, of the timer used by the authenticator state machine on this port to timeout the supplicant. The EAP timeout must be a value in the range of 1 and 255.  
The default value is **30**.
-

## 4.11 MAC Addresses

### 4.11.1 Dynamic Address Table

Use this page to set the Address Ageing Timeout for the MAC Address database, and to display information about entries in the MAC Address database. These entries are used by the transparent bridging function to determine how to forward a received frame. The screen in Figure 4-47 appears.

The screenshot shows the Planet GSD-800S web interface. The top header includes the Planet logo and the device name '8-Port Web Smart Gigabit Ethernet Switch GSD-800S'. A navigation menu on the left lists various configuration options, with 'MAC Addresses' selected. The main content area is titled 'Aging Time Configuration' and features a text input field for 'Aging Time (Seconds)' set to '300' (range 0 ~ 65535) and an 'Apply' button. Below this is the 'MAC Address Table' section, which shows 'MAC Address entries count : 2'. A table displays the following data:

Index	VID	Ports	Type	MAC-Address
1	1	1	Dynamic	00-03-6d-38-06-14
2	1	1	Dynamic	00-30-4f-2c-c2-69

Below the table, there are 'Page 01', 'Refresh', and 'Clear' buttons, and a note 'Maximum display output : 256'.

Figure 4-47 Dynamic Address Table

#### ■ Ageing Timeout Configuration (seconds)

The MAC Address database contains static entries, which are never aged out, and dynamically learned entries, which are removed if they are not updated within a given time. You specify that time by entering a value for the Address Ageing Timeout. You may enter any number of seconds between 0 and 65535.

IEEE 802.1D recommends a default of **300** seconds, which is the factory default.

#### ■ MAC Address Table

The MAC Address Table includes the following fields:

- 
- **MAC Address entries count**      Display the MAC address count numbers.
  - **VID**      The VLAN ID for which the table is queried.
  - **Ports**      Specifies the port numbers for which the table is queried.
  - **Type**      The MAC Address type for which the table is queried. There're two possible type-
    - **Dynamic** - Addresses are associated with ports by learning the ports from the frame source address.
    - **Static** - Static addresses are manually configured. Packets received with the destined MAC address match the port static MAC setting will be forward to the specify port.



- **MAC-Address** Specifies the MAC address for which the table is queried.

### 4.11.2 Static MAC Address

The Static MAC Address page contains a list of static MAC addresses. Static Address can be added and removed from the page. In addition, several MAC Addresses can be defined for a single port. The screen in Figure 4-48 appears.

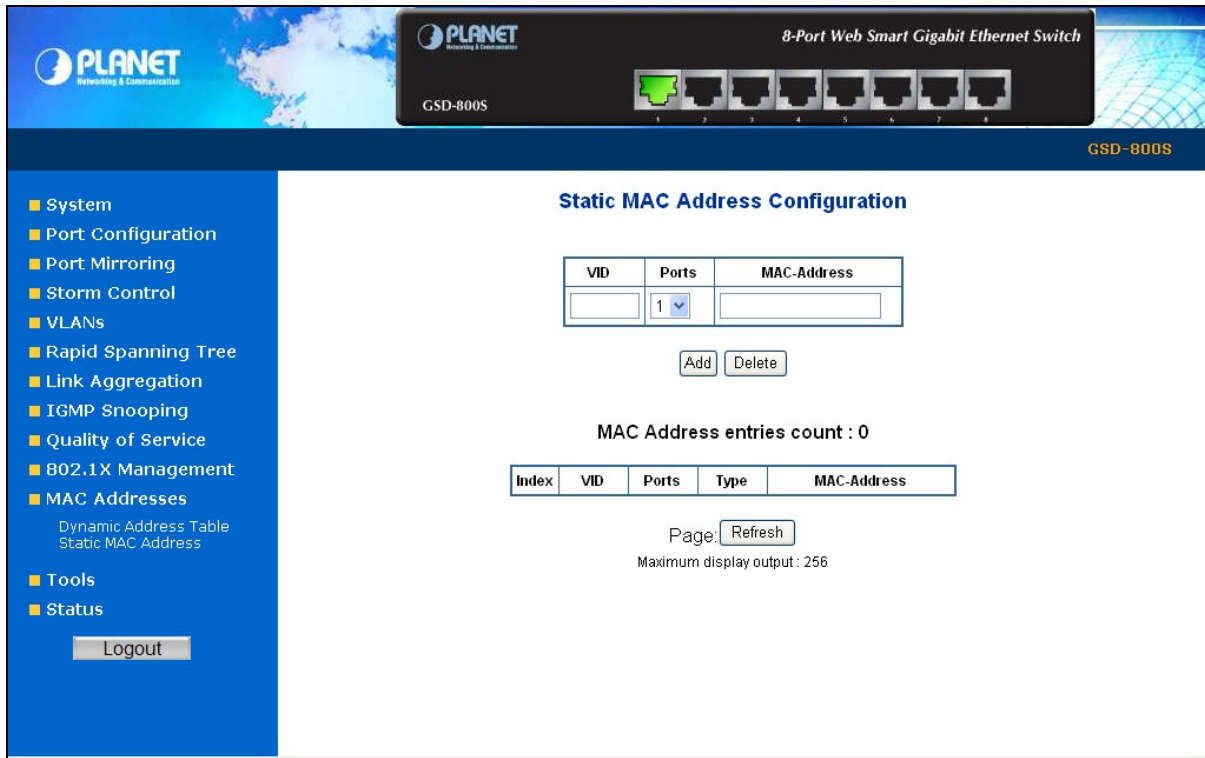

Figure-4-48 Static MAC Address Configuration

The configurable fields includes the following items:

- **VID** The VLAN ID attached to the MAC Address.
- **Ports** Specifies the port numbers for which the table is queried.
- **MAC-Address** Input the MAC address entry be manually bind to the specify port.

The MAC Address Table includes the following fields:

- **VID** The VLAN ID attached to the MAC Address.
- **Ports** Specifies the port numbers for which the table is queried.
- **Type** **Static** - Static addresses are manually configured. Packets received with the destined MAC address match the port static MAC setting will be forward to the specify port.
- **MAC-Address** The MAC address listed in the current static address list.

## 4.12 Tools

### 4.12.1 Reboot

The **Reboot** page enables the device to be rebooted from a remote location. Once the Reboot button be pressed, user have to re-login the WEB interface about 20 seconds later, the screen in Figure 4-49 appears.

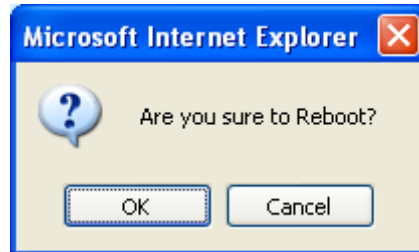

Figure 4-49 Reboot screen

### 4.12.2 Factory Reset

The Factory Reset button can reset the Gigabit Ethernet Switch back to the factory default mode. Be aware that the entire configuration will be reset; expect the IP address of the Gigabit Ethernet Switch. Once the Factory Reset item be pressed, the screen in Figure 4-50 appears.



Figure 4-50 Factory Reset screen

**Notice:** To reset the IP address to the default IP Address “192.168.0.100”. Press the hardware reset button at the front panel about 5 seconds. After the device be rebooted. You can login the management WEB interface within the same subnet of 192.168.0.xx.

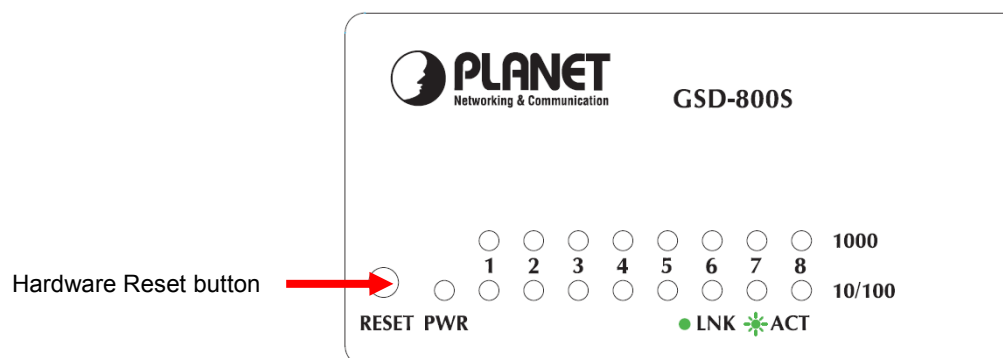

### 4.12.3 Firmware Upgrade

The **Firmware Upgrade** page contains fields for downloading system image files from the Local File browser to the device.

To open **Firmware Upgrade** screen perform the following:

1. Click **Tools** -> **Firmware Upgrade**.
2. The Firmware Upgrade screen is displayed as in Figure 4-51.
3. Click the **"Browse"** button of the main page, the system would pop up the file selection menu to choose firmware.
4. Select on the firmware then click **"Upload"**, the **Software Upload Progress** would show the file upload status.

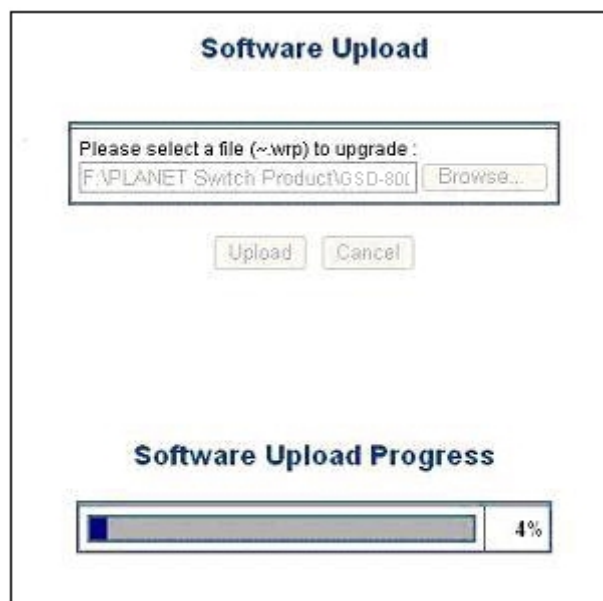

Figure 4-51 Firmware Upgrade screen

5. Once the software be loaded to the system successfully. The following screen appears. Click the **"Yes"** button to activate the new software immediately. The system will load the new software after reboot.

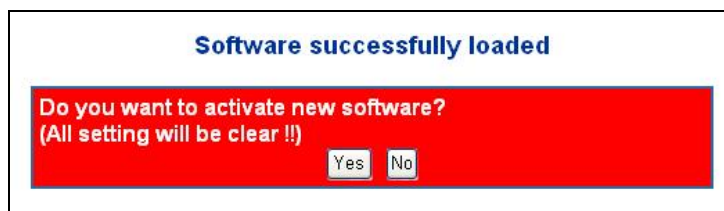

Figure 4-52 Software successfully loaded notice screen

---

**Notice:** Do not power off the switch until the update progress is complete.

---

**Notice:** Do not quit the Firmware Upgrade page without press the **"Yes"** button - after the image be loaded. Or the system won't apply the new firmware. User has to repeat the firmware upgrade processes again.

---

## 4.12.4 Configuration Upload

This function allows backup and reload the current configuration of Switch to the local management station. The screen in Figure 4-53 appears.

- **Configuration Upload:** Upload the existed configuration file to the Switch. The configuration file had been saved at the local machine already.
- **Configuration Download:** Download the current configuration file of the switch to the local machine.

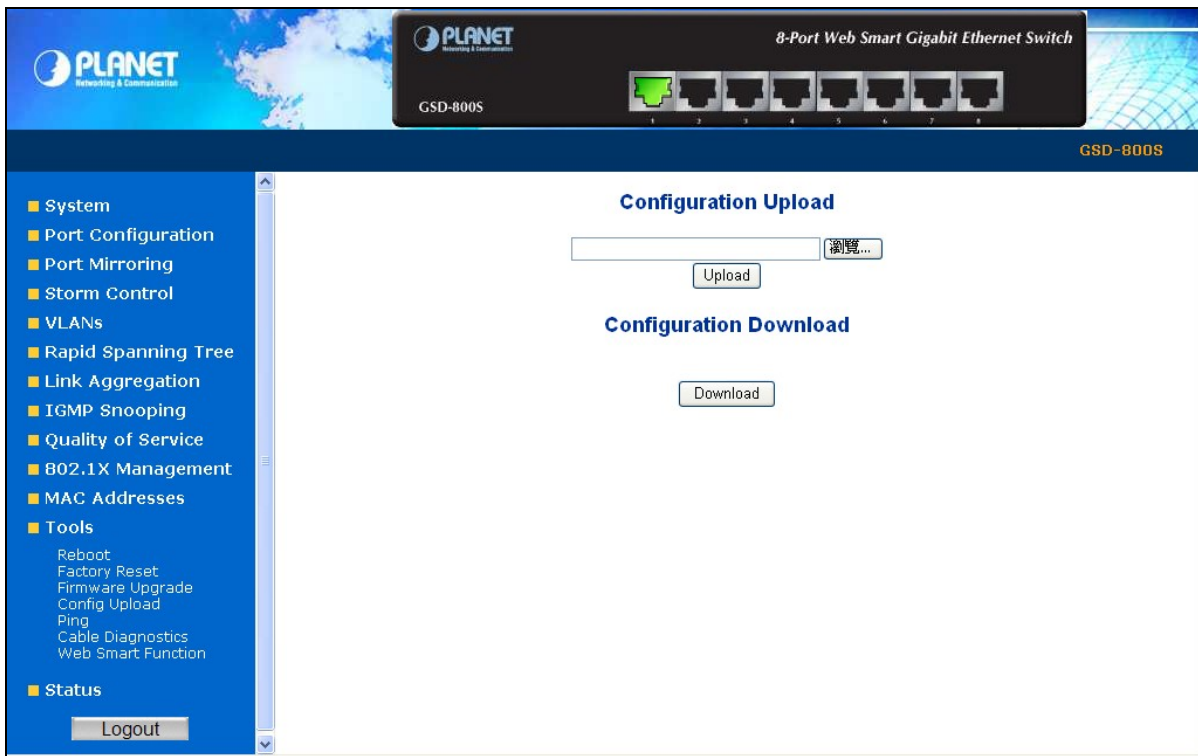

Figure 4-53 Configuration Upload/Download screen

### ■ Configuration Upload

1. Click the **"Browse"** button of the main page, the system would pop up the file selection menu to choose saved configuration.

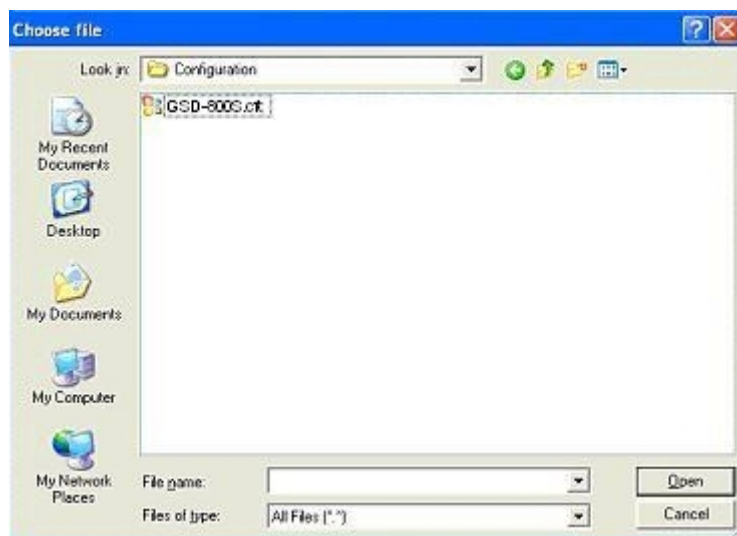

Figure 4-54 Windows file selection menu popup

2. Select on the configuration file then click **“Upload”**, the bottom of the browser shows the upload status.
3. After down, the main screen appears **“Transfer Completed”**.

■ **Configuration Download**

1. Press the **“Download”** button to save the current configuration in manager workstation. The following screens in Figure 4-55 and 4-56 appear



Figure 4-55 File Download screen

2. Chose the file save path in management workstation.

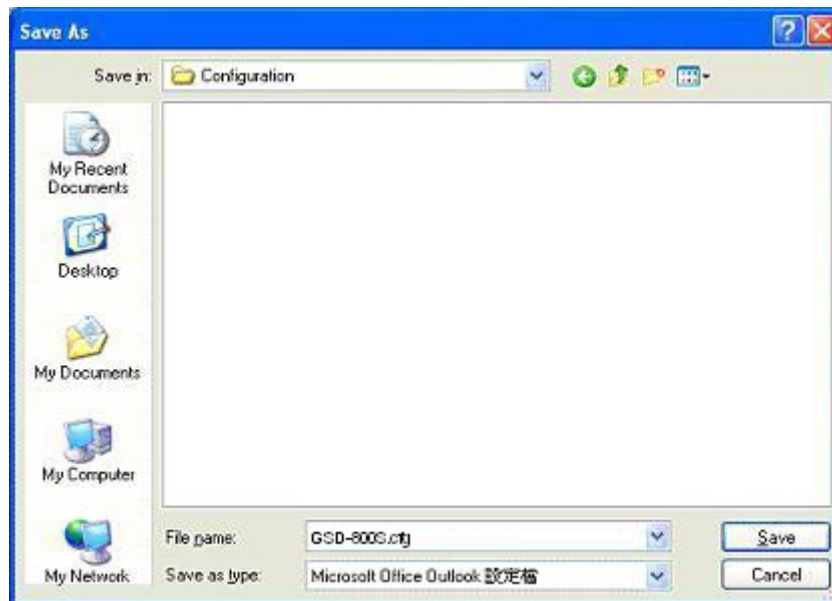

Figure 4-56 File save screen

## 4.12.5 Ping

Use this screen to tell the switch to send a Ping request to a specified IP address. You can use this to check whether the switch can communicate with a particular IP station. Once you click the Apply button, the switch will send **n** pings and the results will be displayed below the configurable data.

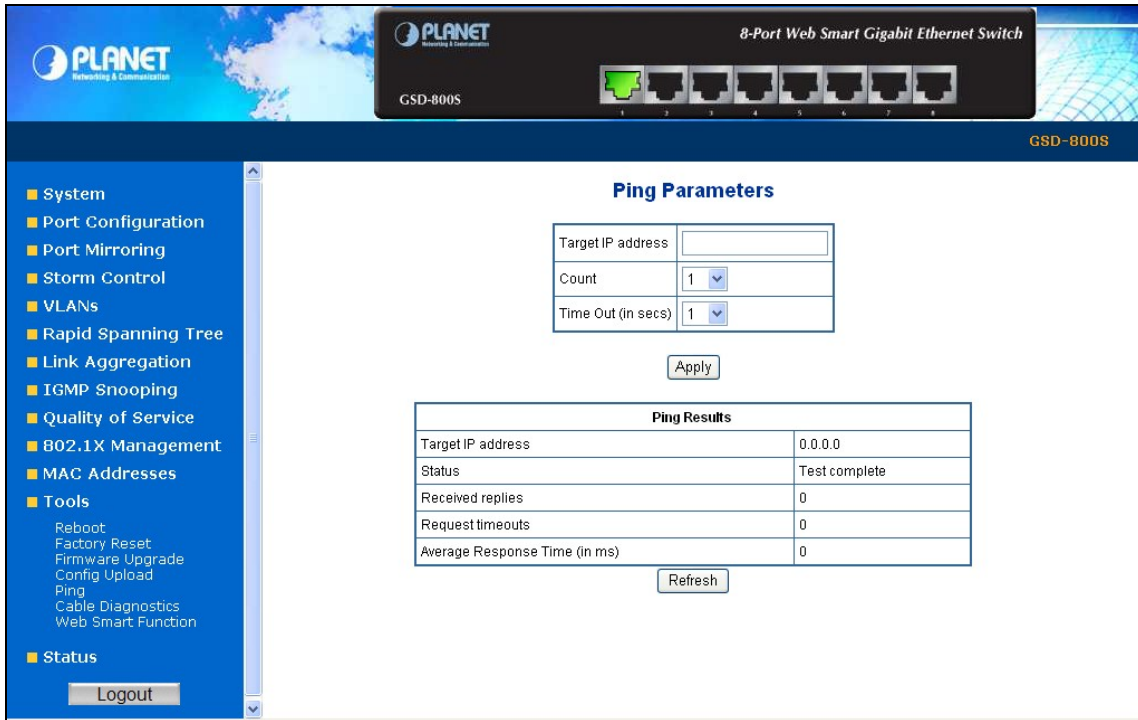

Figure 4-57 Ping function screen

The Ping Parameters includes the following fields:

- **Target IP Address** Enter the IP address of the station you want the switch to ping. The initial value is blank. The IP Address you enter is not retained across a power cycle.
- **Count** Number of echo requests to send.
- **Time Out (in secs)** Timeout in milliseconds to wait for each reply.

After field the parameter and press “**Apply**” to execute the Ping function. The Ping result shows at the next table. As the Figure 4-58 screen appears.

Ping Results	
Target IP address	192.168.0.254
Status	Test complete
Received replies	0
Request timeouts	1
Average Response Time (in ms)	0

Refresh

Figure 4-58 Ping Result screen

**Notice:**

Be sure the target IP Address is within the same network subnet of the switch, or you had setup the correct gateway IP address.

## 4.12.6 Cable Diagnostics

The Cable Diagnostics page contains fields for performing tests on copper cables. These functions have the ability to identify the cable length and operating conditions, and to isolate a variety of common faults that can occur on the Cat5 twisted-pair cabling. There might be two statuses as follow:

- If the link is established on the twisted-pair interface in 1000BASE-T mode, the Cable Diagnostics can run without disruption of the link or of any data transfer.
- If the link is established in 100BASE-TX or 10BASE-T, the Cable Diagnostics cause the link to drop while the diagnostics are running.

After the diagnostics are finished, the link is reestablished. And the following functions are available.

- Coupling between cable pairs.
- Cable pair termination
- Cable Length

Anomalous coupling between cable pairs can be caused by shorted wires, improper termination, or high crosstalk resulting from an incorrect wire map. These conditions can all prevent the PLANET switch from establishing a link. The screen in Figure 4-59 appears.

### Cable Diagnostics

Port	Port 1 <span style="float: right;">▼</span>
Mode	Full <span style="float: right;">▼</span>

Cable Status		
Pair	Length [m]	Status
A (Pin 1,2)	4	Proper
B (Pin 3,6)	4	Proper
C (Pin 4,5)	4	Proper
D (Pin 7,8)	4	Proper

**Figure 4-59** Cable Diagnostics

The Cable Diagnostics includes the following fields:

- |               |   |
|---------------|---|
| <b>• Port</b> | Specifies the port numbers for which to run the cable diagnostics.  |
| <b>• Mode</b> | There're three cable test mode for selection:<br><b>Full</b> – test full pairs.<br><b>Anomaly</b> – test with only anomaly pairs.<br><b>Anomaly w/o X-pair</b> - test anomaly pairs but without X-pair. |

The Cable status includes the following items:

- 
- **Pair**                      The twist pair of the UTP cable. The pair groups as follow:  
                                  **A (Pin 1,2)**  
                                  **B (Pin 3,6)**  
                                  **C (Pin 4,5)**  
                                  **D (Pin 7,8)**
  
  - **Length[m]**                When properly terminated, Cable Diagnostics reports the approximate cable length in meters of each of the four cable pair A, B, C, and D.
  
  - **Status**                     The cable test results. Possible values are:
    - **Proper** - The cable passed the test.
    - **Open** - The cable is connected on only one side or there is no cable connected to the port
    - **Short** - A short has occurred in the cable. With 10/100BASE link, the status of Pair C and Pair D will be "Short".
    - **Abnormal termination** – An improper termination be detected. Proper termination of Cat5 cable requires a 100Ω differential impedance between the positive and negative cable terminals. IEEE Std 802.3 allows for a termination of as large as 115Ω or as small as 85Ω. If the termination falls out of this range, it is reported as falls an anomalous termination.
- 

---

 **Notice:** Be sure to running the Cable diagnostics with standard Cat 5e or Cat 6 UTP cable. With some of the UTP cables that not match the standard of Cat 5e, it might cause the 10/100Base link down after the cable diagnostics.

---



### 4.12.7 Web Smart Function

This function could provide you to define device indicate connect to each port on Web Smart Switch, the screen in Figure 4-60 appears.

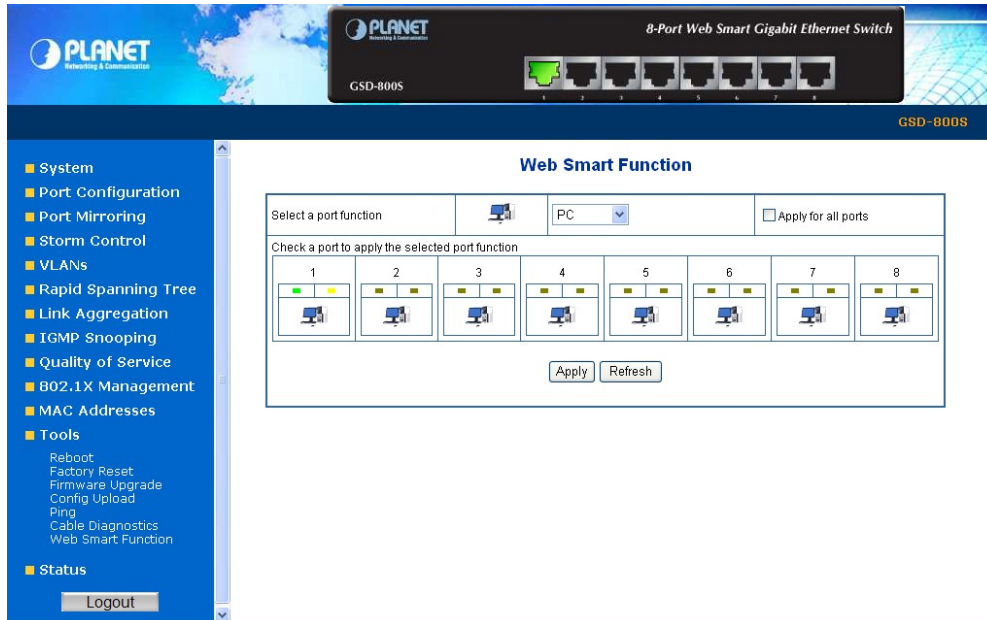











Figure 4-60 Web Smart Function Web Page screen

The available options are shown as below:

1	PC	
2	PC+VoIP	
3	Switch	
4	Router	
5	AP	
6	Server	
7	Printer	
8	Guest	
9	Other	

The screen in Figure 4-61 appears and the setup procedure shown as below:

1. Choose a device from options of Select a port function, the screen in Figure 4-61 appears.
2. Check the port that need to marked, the screen in Figure 4-62 appears.

3. After setup completed, press “Apply” to save current configuration, the screen in Figure 4-62 appears.

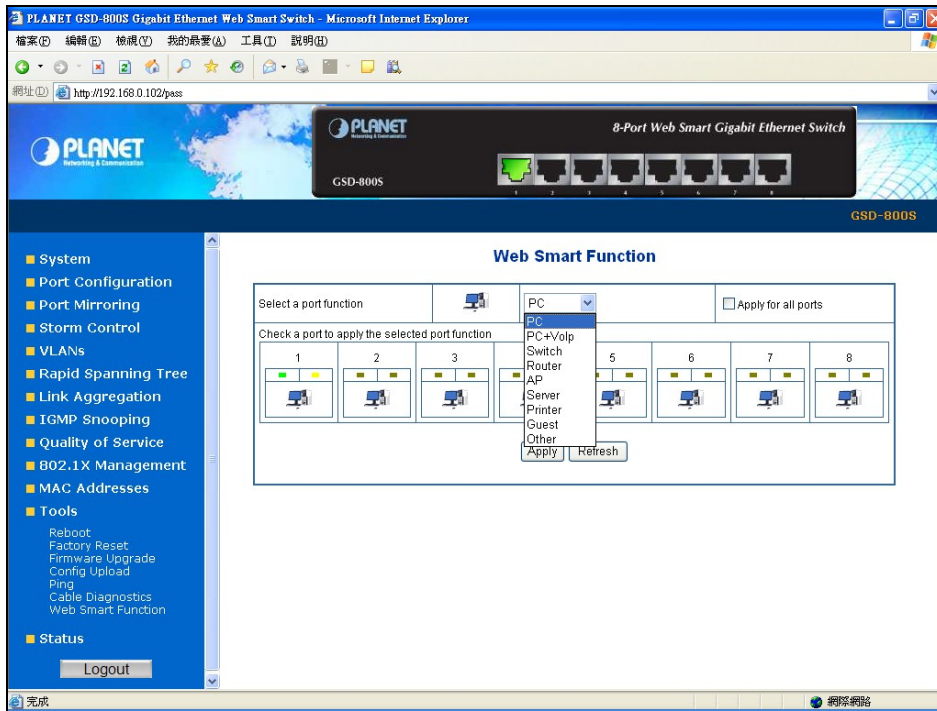

Figure 4-61 Web Smart Function Web Page screen

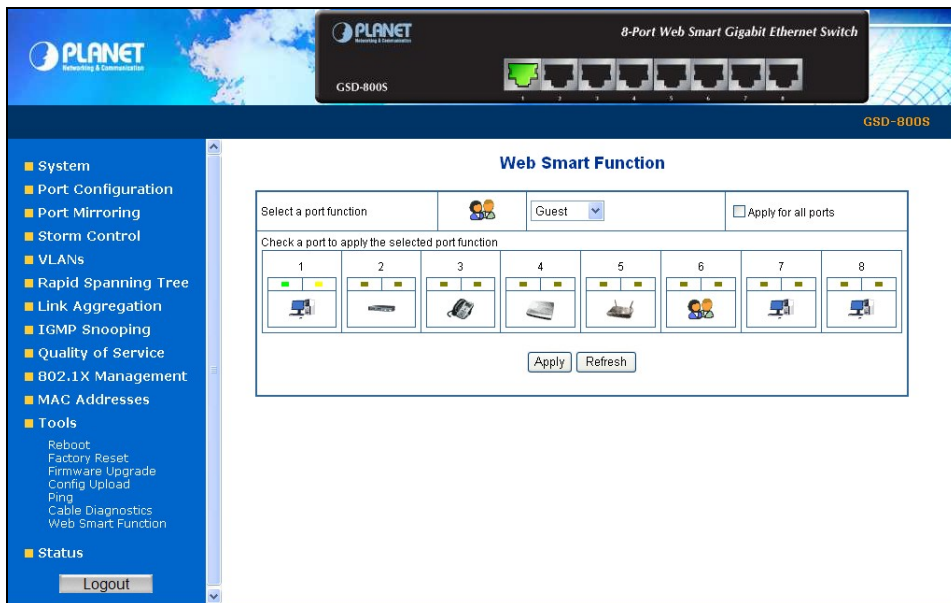

Figure 4-62 Web Smart Function Web Page screen

This function also provides **Apply for all ports** option from Select a port function, the setup procedure shown as below:

1. Choose a device and check “**Apply for all ports**” from options of Select a port function, the screen in Figure 4-63 appears.
2. Check any port then all port will be select; the screen in Figure 4-64 appears.
3. After setup completed, press “**Apply**” to save current configuration, the screen in Figure 4-69 appears.

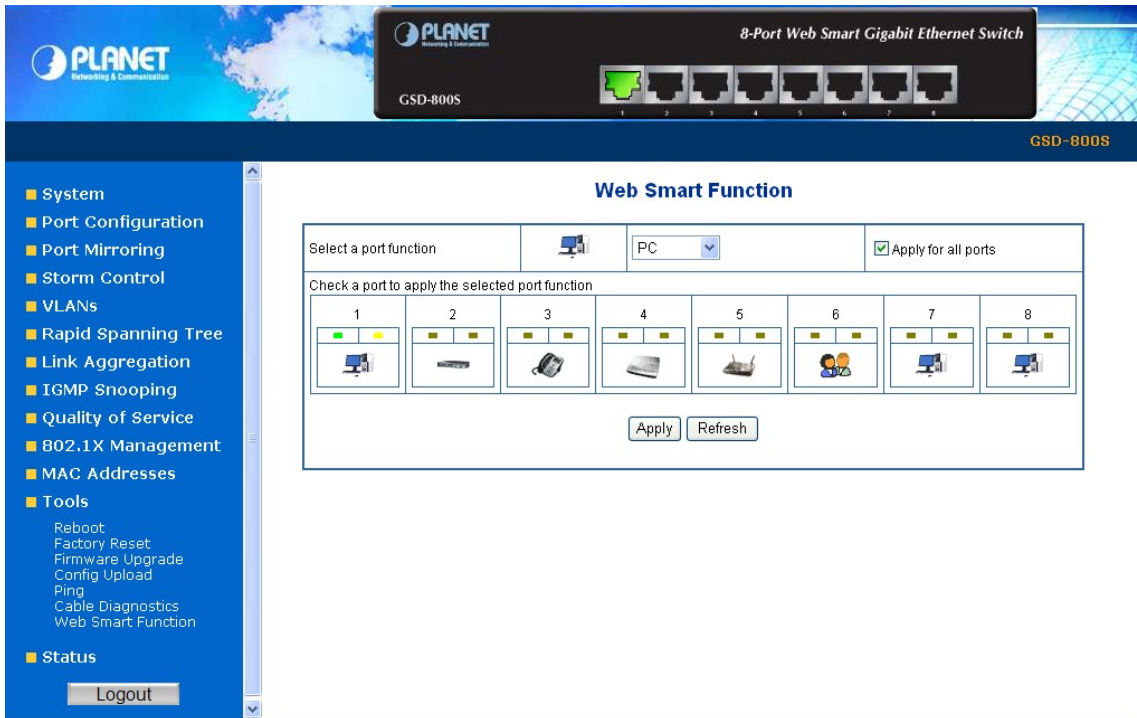

Figure 4-63 Web Smart Function Web Page screen

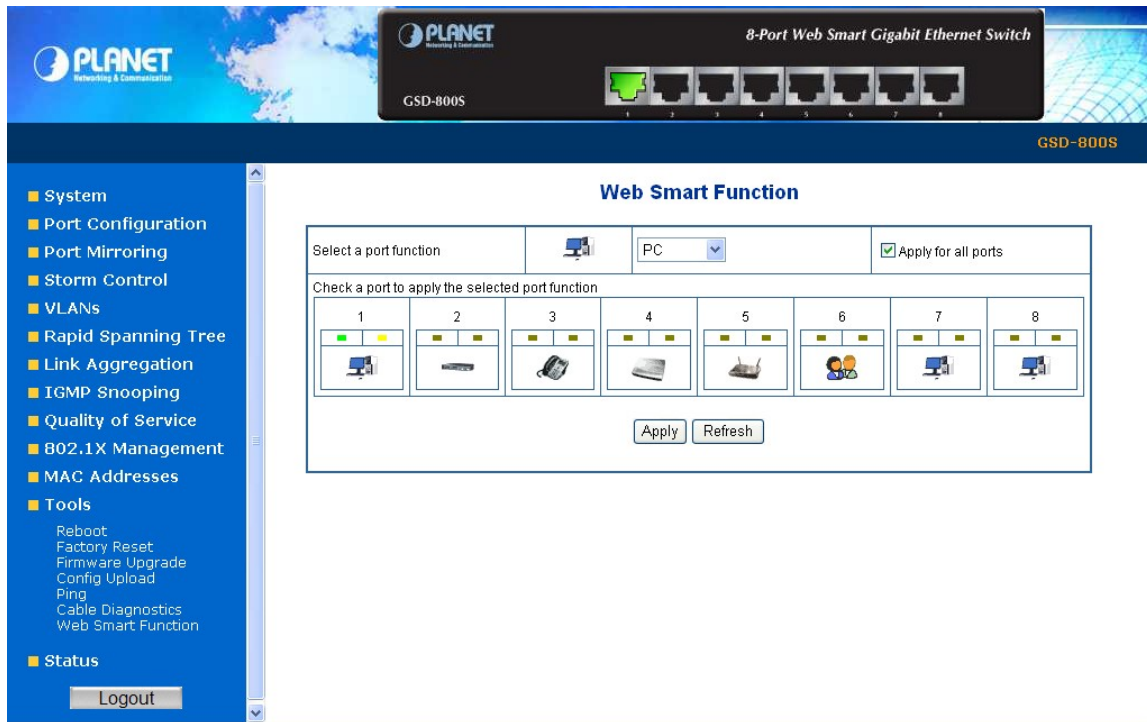

Figure 4-64 Web Smart Function Web Page screen

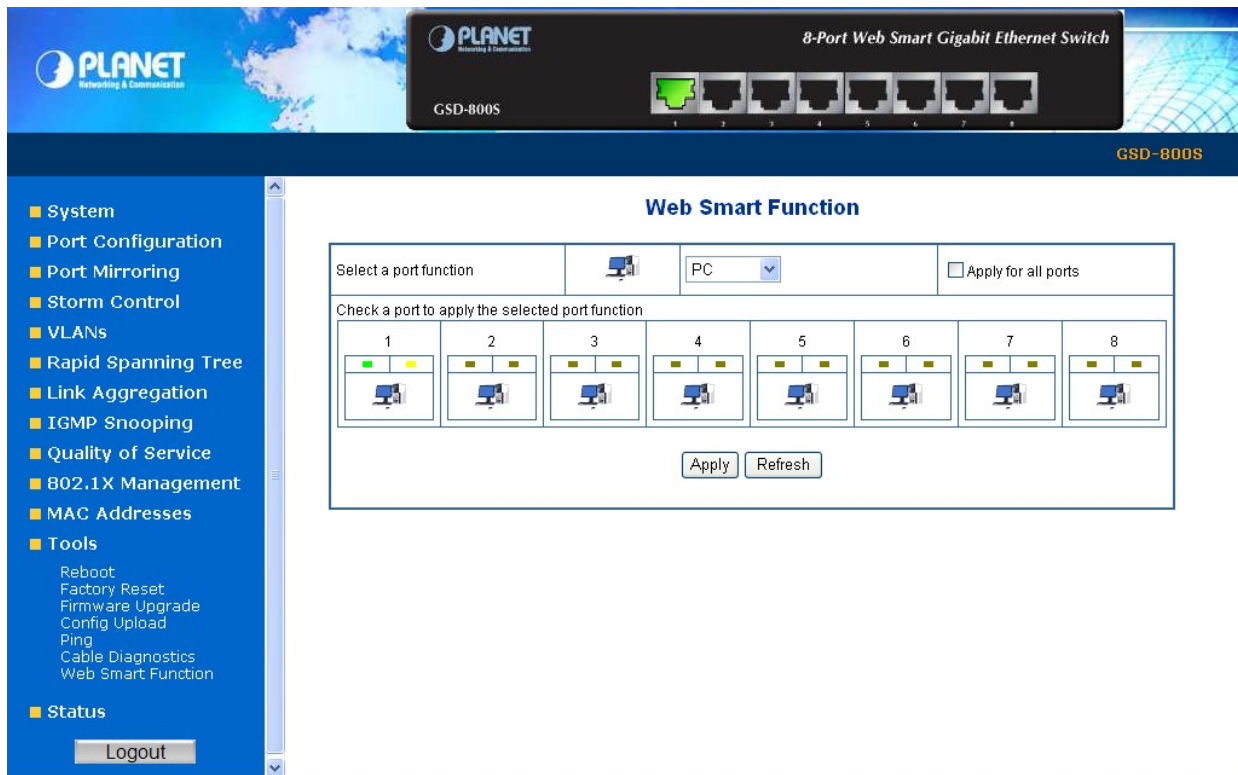

Figure 4-65 Web Smart Function Web Page screen

## 4.13 Status

Click on the “**Status**” to present the Switch status on this screen, it displays the following status:

- **Port Statistics**
- **LACP Status**
- **RSTP Status**
- **IGMP Snooping Status**
- **Multicast Group Table**

### 4.13.1 Port Statistics

The Port Statistic Overview page displays the status of packet count from each port. The Port statistics overview screen in Figure 4-66 appears.

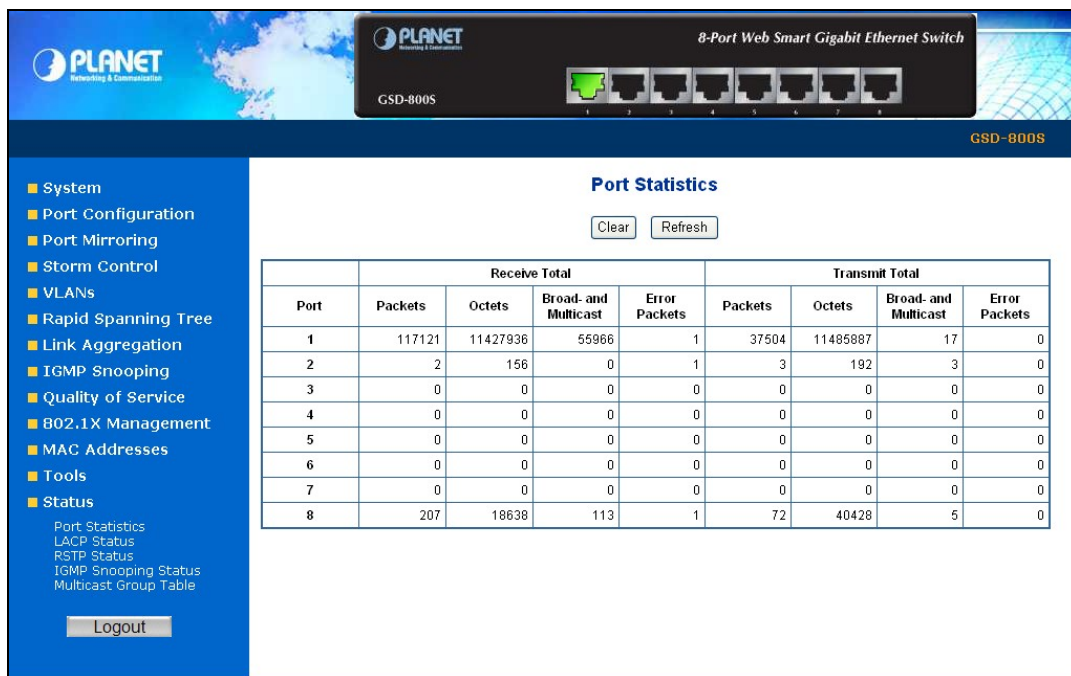

Figure 4-66 Port Statistics Overview screen

The page includes the following fields:

- **Port** The Port number.
- **Receive Packets** Number of packets received on the port. Include the Unicast packets.
- **Receive Octets** Number of octets of data (including those in bad packets) received on the port. This object can be used as a reasonable estimate of Ethernet utilization.
- **Broad- and Multicast** Number of packets received on the port. Include the broadcast and multicast packets.
- **Error Packets** The numbers of error packets received from the port.
- **Transmit Packets** Number of packets transmitted on the port. Include the Unicast packets.

- **Transmit Octets**      Number of octets of data (including those in bad packets) transmitted on the port. This object can be used as a reasonable estimate of Ethernet utilization.
- **Broad- and Multicast**      Number of packets transmitted on the port. Include the broadcast and multicast packets.
- **Error Packets**      The numbers of error packets transmit from the port.

### 4.13.2 LACP Status

The LACP Status page display the current LACP aggregation Groups and LACP Port status.

Please refer to [Chapter 4.7.3](#) at page-49 for more detail.

### 4.13.3 RSTP Status

The RSTP Status page display the current STP bridge , roor bridge and per port stp status.

Please refer to [Chapter 4.6.3](#) at page-44 for more detail.

### 4.13.4 IGMP Snooping Status

The IGMP Snooping page display the current IGMP Status and the statistics of received Query / report packets.

Please refer to [Chapter 4.8.2](#) at page-53 for more detail.

### 4.13.5 Multicast Group Status

The Multicast Group page displays the ports attached to the Multicast service group in the Ports tables. The Port a tables also reflect the manner in which the port joined the Multicast group. Ports can be added either to existing groups or to new Multicast service groups. The Bridge Multicast Group page permits new Multicast service groups to be created. The Bridge Multicast Group page also assigns ports to a specific Multicast service address group.

Please refer to [Chapter 4.8.3](#) at page-54 for more detail

## Logout

Press this function; the web interface will go back to login screen. The screen in Figure 4-67 and Figure 4-68 appears.

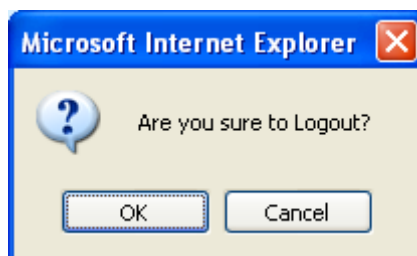

Figure 4-67 Logout screen

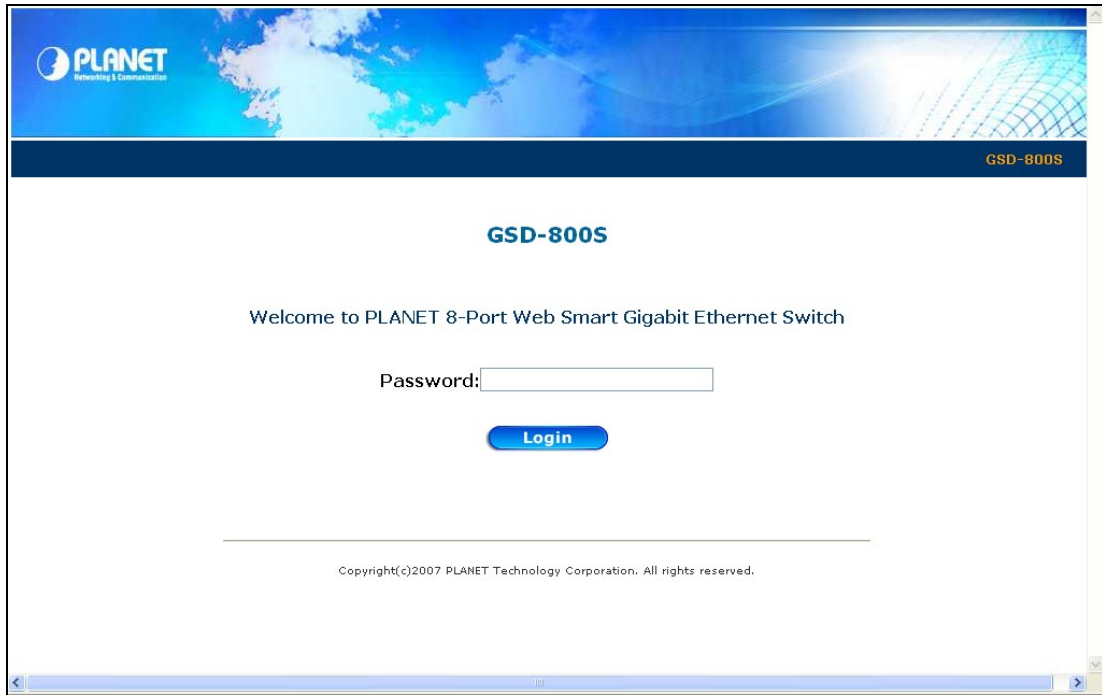

Figure 4-68 Login screen

### 4.14 PoE Configuration ( GSD-802PS Only)

The GSD-802PS is an 8 ports PoE Layer 2 Web Smart switch, it supports up to 8 ports PoE Power source (PSE) to supply PoE power for the connected Power Device (PD).

**■ Power Management:**

In a power over Ethernet system, operating power is applied from a power source (PSU-power supply unit) over the LAN infrastructure to powered devices (PDs), which are connected to ports. Under some conditions, the total output power required by PDs can exceed the maximum available power provided by the PSU. The system may a prior be planed with a PSU capable of supplying less power than the total potential power consumption of all the PoE ports in the system. In order to maintain the majority of ports active, power management is implemented.

The PSU input power consumption is monitored by measuring voltage and current .The input power consumption is equal to the system's aggregated power consumption .The power management concept allows all ports to be active and activates additional ports, as long as the aggregated power of the system is lower than the power level at which additional PDs cannot be connected .When this value is exceeded, ports will be deactivated, according to user-defined priorities. The power budget is managed according to the following user-definable parameters: maximum available power, ports priority, maximum allowable power per port.

This section provides PoE (Power over Ethernet) Configuration and PoE output status of GSD-802PS, screen in Figure 4-69 appears. After setup completed, please press “**Apply**” button to take effect.

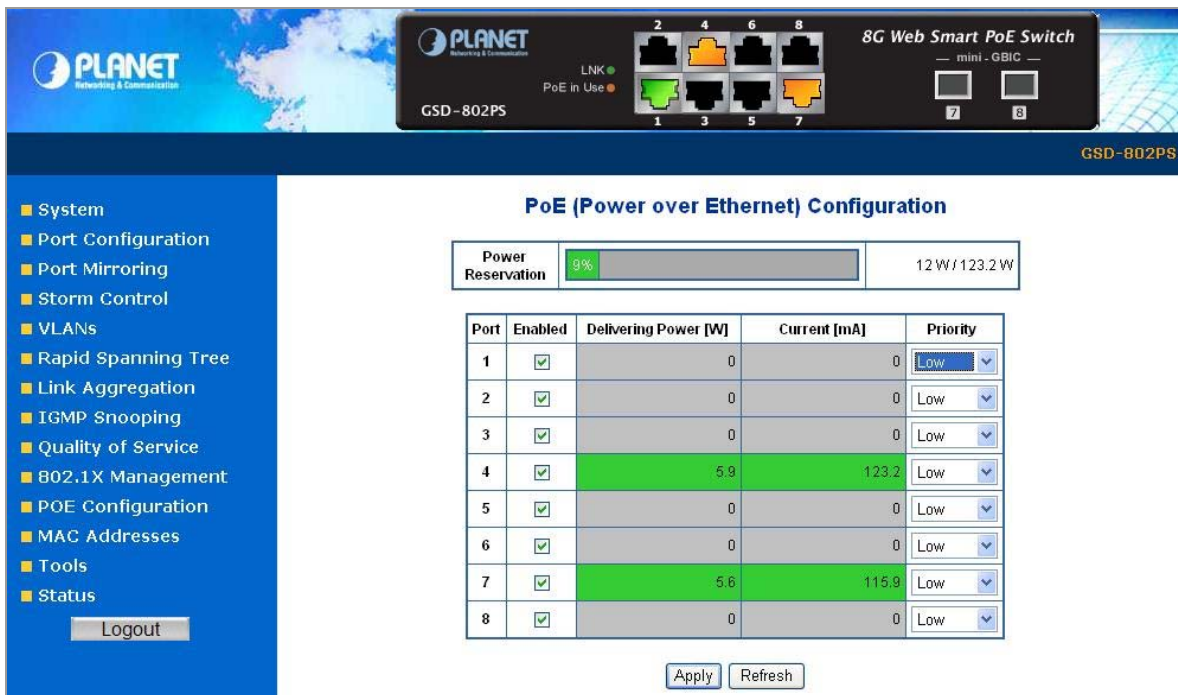

**Figure4-69** GSD-802PS POE Configuration Web Page screen

The page includes the following fields:

- Power Reservation**      The summary list of Current(mA) and Power(watts).
- Port**                      Indicate port 1 to port 8.
- Enabled**                  Allow to disable or enable each POE port.



- Delivering Power [W]** List each connected device power usage.
- Current [mA]** List each connected device current usage.
- Priority** Allow to assign the POE power provision priority on each POE port, the available values are
- **Low**
  - **Medium**
  - **High**

Also, from the Switch panel at the top side, the orange port icon  shows that the port is connected to PDs with PoE output. For more detail status about the usage of each PoE port, the Delivering Power and Current [mA] columns shows the current power usage.



### PoE (Power over Ethernet) Configuration



Port	Enabled	Delivering Power [W]	Current [mA]	Priority
1	<input checked="" type="checkbox"/>	0	0	Low
2	<input checked="" type="checkbox"/>	0	0	Low
3	<input checked="" type="checkbox"/>	0	0	Low
4	<input checked="" type="checkbox"/>	5.9	123.2	Low
5	<input checked="" type="checkbox"/>	0	0	Low
6	<input checked="" type="checkbox"/>	0	0	Low
7	<input checked="" type="checkbox"/>	5.8	115.9	Low
8	<input checked="" type="checkbox"/>	0	0	Low

**Notice:** With some of the Gigabit NICs those support VCT( Virtual Cable Test) or other detection functions, the Gigabit NICs might be see as a PDs and the PoE status shows Orange port icon. At this moment the PoE Switch just send detection signal with lower voltage, it will not cause damage to the client.

## **5. SWITCH OPERATION**

### **5.1 Address Table**

The Switch is implemented with an address table. This address table composed of many entries. Each entry is used to store the address information of some node in network, including MAC address, port no, etc. This information comes from the learning process of Ethernet Switch.

### **5.2 Learning**

When one packet comes in from any port, the Switch will record the source address, port no. And the other related information in address table. This information will be used to decide either forwarding or filtering for future packets.

### **5.3 Forwarding & Filtering**

When one packet comes from some port of the Ethernet Switching, it will also check the destination address besides the source address learning. The Ethernet Switching will lookup the address-table for the destination address. If not found, this packet will be forwarded to all the other ports except the port, which this packet comes in. And these ports will transmit this packet to the network it connected. If found, and the destination address is located at different port from this packet comes in, the Ethernet Switching will forward this packet to the port where this destination address is located according to the information from address table. But, if the destination address is located at the same port with this packet comes in, then this packet will be filtered. There by increasing the network throughput and availability.

### **5.4 Store-and-Forward**

Store-and-Forward is one type of packet-forwarding techniques. A Store-and-Forward Ethernet Switching stores the incoming frame in an internal buffer, do the complete error checking before transmission. Therefore, no error packets occurrence, it is the best choice when a network needs efficiency and stability.

The Ethernet Switch scans the destination address from the packet-header, searches the routing table provided for the incoming port and forwards the packet, only if required. The fast forwarding makes the switch attractive for connecting servers directly to the network, thereby increasing throughput and availability. However, the switch is most commonly used to segment existing hubs, which nearly always improves overall performance. An Ethernet Switching can be easily configured in any Ethernet network environment to significantly boost bandwidth using conventional cabling and adapters.

Due to the learning function of the Ethernet switching, the source address and corresponding port number of each incoming and outgoing packet are stored in a routing table. This information is subsequently used to filter packets whose destination address is on the same segment as the source address. This confines network traffic to its respective domain, reducing the overall load on the network.

The Switch performs "Store and forward" therefore, no error packets occur. More reliably, it reduces the re-transmission rate. No packet loss will occur.

## 5.5 Auto-Negotiation

The STP ports on the Switch have built-in “Auto-negotiation”. This technology automatically sets the best possible bandwidth when a connection is established with another network device (usually at Power On or Reset). This is done by detect the modes and speeds at the second of both device is connected and capable of, both 10Base-T and 100Base-TX devices can connect with the port in either Half- or Full-Duplex mode. 1000Base-T can be only connected in Full-duplex mode.

## 5.6 IGMP Snooping

### Theory

Computers and network devices that want to receive multicast transmissions need to inform nearby routers that they will become members of a multicast group. The Internet Group Management Protocol (IGMP) is used to communicate this information. IGMP is also used to periodically check the multicast group for members that are no longer active. In the case where there is more than one multicast router on a sub network, one router is elected as the ‘queried’. This router then keeps track of the membership of the multicast groups that have active members. The information received from IGMP is then used to determine if multicast packets should be forwarded to a given sub network or not. The router can check, using IGMP, to see if there is at least one member of a multicast group on a given subnet work. If there are no members on a sub network, packets will not be forwarded to that sub network.

### IGMP Versions 1 and 2

Multicast groups allow members to join or leave at any time. IGMP provides the method for members and multicast routers to communicate when joining or leaving a multicast group.

IGMP version 1 is defined in RFC 1112. It has a fixed packet size and no optional data.

The format of an IGMP packet is shown below:

#### IGMP Message Format

Octets

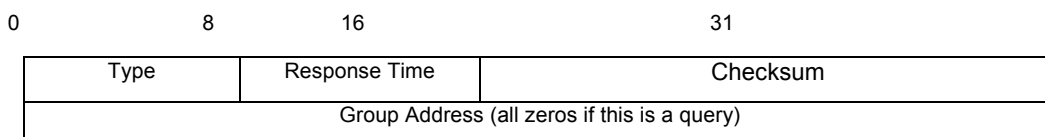

The IGMP Type codes are shown below:

#### Type Meaning

- 0x11** Membership Query (if Group Address is 0.0.0.0)
- 0x11** Specific Group Membership Query (if Group Address is Present)
- 0x16** Membership Report (version 2)
- 0x17** Leave a Group (version 2)
- 0x12** Membership Report (version 1)

IGMP packets enable multicast routers to keep track of the membership of multicast groups, on their respective sub networks. The following outlines what is communicated between a multicast router and a multicast group member using IGMP.

A host sends an IGMP “**report**” to join a group

A host will never send a report when it wants to leave a group (for version 1).

A host will send a “**leave**” report when it wants to leave a group (for version 2).

Multicast routers send IGMP queries (to the all-hosts group address: 224.0.0.1) periodically to see whether any group members exist on their sub networks. If there is no response from a particular group, the router assumes that there are no group members on the network.

The Time-to-Live (TTL) field of query messages is set to 1 so that the queries will not be forwarded to other sub networks.

IGMP version 2 introduces some enhancements such as a method to elect a multicast queried for each LAN, an explicit leave message, and query messages that are specific to a given group.

The states a computer will go through to join or to leave a multicast group are shown below:

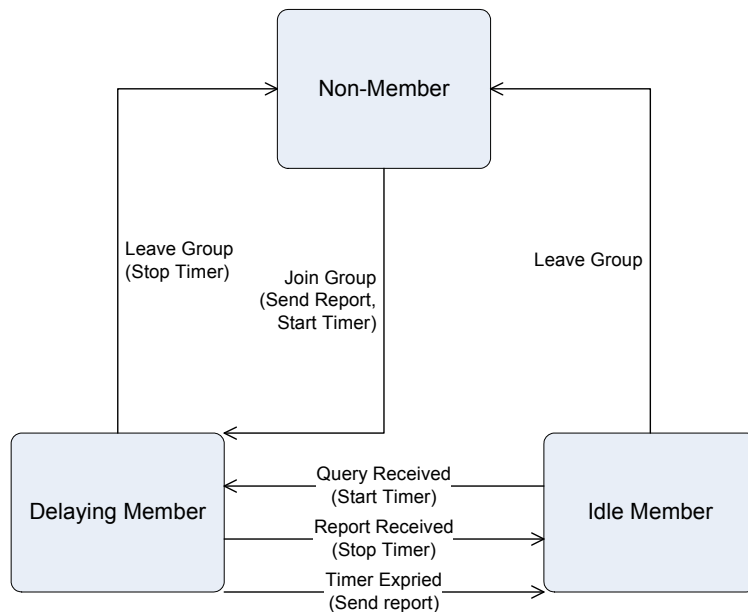

IGMP State Transitions

## 6. TROUBLESHOOTING

This chapter contains information to help you solve problems. If the Switch is not functioning properly, make sure the Ethernet Switch was set up according to instructions in this manual.

### **The Link LED is not lit**

Solution:

Check the cable connection and remove duplex mode of the Switch.

### **Some stations cannot talk to other stations located on the other port**

Solution:

Please check the VLAN, port trunking function that may introduce this kind of problem.

### **Performance is bad**

Solution:

Check the full duplex status of the Ethernet Switch. If the Ethernet Switch is set to full duplex and the partner is set to half duplex, then the performance will be poor.

### **100Base-TX port link LED is lit, but the traffic is irregular**

Solution:

Check that the attached device is not set to dedicate full duplex. Some devices use a physical or software switch to change duplex modes. Auto-negotiation may not recognize this type of full-duplex setting.

### **Why the Switch doesn't connect to the network**

Solution:

Check the LNK/ACT LED on the switch .Try another port on the Switch. Make sure the cable is installed properly  
Make sure the cable is the right type Turn off the power. After a while, turn on power again.

### **How to deal forgotten password situation of switch?**

Solution:

Please contact Planet switch support team and the mail address is [support\\_switch@planet.com.tw](mailto:support_switch@planet.com.tw)

## APPENDIX A

### A.1 Switch's RJ-45 Pin Assignments

1000Mbps, 1000Base T

Contact	MDI	MDI-X
1	BI_DA+	BI_DB+
2	BI_DA-	BI_DB-
3	BI_DB+	BI_DA+
4	BI_DC+	BI_DD+
5	BI_DC-	BI_DD-
6	BI_DB-	BI_DA-
7	BI_DD+	BI_DC+
8	BI_DD-	BI_DC-

Implicit implementation of the crossover function within a twisted-pair cable, or at a wiring panel, while not expressly forbidden, is beyond the scope of this standard.

### A.2 10/100Mbps, 10/100Base-TX

RJ-45 Connector pin assignment		
Contact	MDI Media Dependant Interface	MDI-X Media Dependant Interface -Cross
1	Tx + (transmit)	Rx + (receive)
2	Tx - (transmit)	Rx - (receive)
3	Rx + (receive)	Tx + (transmit)
4, 5	Not used	
6	Rx - (receive)	Tx - (transmit)
7, 8	Not used	

### A.3 RJ-45 cable pin assignment

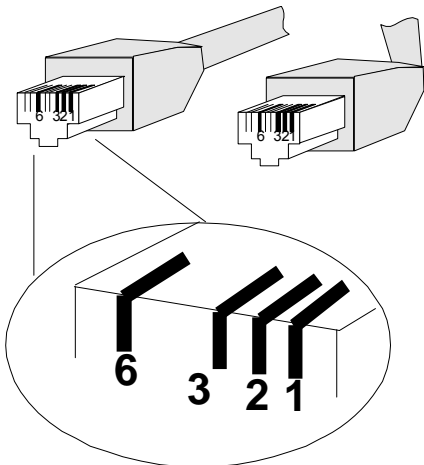

There are 8 wires on a standard UTP/STP cable and each wire is color-coded. The following shows the pin allocation and color of straight cable and crossover cable connection:



Figure A-1: Straight-Through and Crossover Cable

Please make sure your connected cables are with same pin assignment and color as above picture before deploying the cables into your network.

## EC Declaration of Conformity

For the following equipment:

\*Type of Product: 8-Port Gigabit Web Smart PoE Switch

\*Model Number: GSD-802PS

\* Produced by:

Manufacturer's Name : **Planet Technology Corp.**

Manufacturer's Address : 11F, No. 96, Min Chuan Road, Hsin Tien  
Taipei, Taiwan, R.O.C.

is herewith confirmed to comply with the requirements set out in the Council Directive on the Approximation of the Laws of the Member States relating to Electromagnetic Compatibility (89/336/EEC, 92/31/EEC, 93/68/EEC).

For the evaluation regarding the Electromagnetic Compatibility, the following standards were applied:

Emission	EN 55022	(1994 + A1:1995 + A2:1997 Class A)
Harmonic Flicker	EN 61000-3-2 EN 61000-3-3	(2000, Class A) (1995 + A1:2001)
Immunity	EN 55024	(1998 + A1:2001 + A2:2003)
ESD	EN 61000-4-2	(2001)
RS	EN 61000-4-3	(2002 + A1:2002)
EFT/ Burst	EN 61000-4-4	(1995 + A1:2000 + A2:2001)
Surge	EN 61000-4-5	(2001)
CS	EN 61000-4-6	(2001)
Magnetic Field	EN 61000-4-8	(2001)
Voltage Disp	EN 61000-4-11	(2001)

**Responsible for marking this declaration if the:**

**Manufacturer**       **Authorized representative established within the EU**

**Authorized representative established within the EU (if applicable):**

**Company Name:**      **Planet Technology Corp.**

**Company Address:**    **11F, No.96, Min Chuan Road, Hsin Tien, Taipei, Taiwan, R.O.C**

**Person responsible for making this declaration**

**Name, Surname**      **Kent Kang**

**Position / Title :**      **Product Manager**

Taiwan  
Place

24th ,Aug, 2007  
Date

  
\_\_\_\_\_  
Legal Signature

### PLANET TECHNOLOGY CORPORATION





## EC Declaration of Conformity

For the following equipment:

\*Type of Product : 8-Port 10/100/1000Mbps Gigabit Ethernet / Smart Switch

\*Model Number : GSD-800, GSD-800S

\* Produced by:

Manufacturer's Name : **Planet Technology Corp.**

Manufacturer's Address : 11F, No. 96, Min Chuan Road, Hsin Tien  
Taipei, Taiwan , R. O.C.

is herewith confirmed to comply with the requirements set out in the Council Directive on the Approximation of the Laws of the Member States relating to Electromagnetic Compatibility Directive on (89/336/EEC).

For the evaluation regarding the EMC, the following standards were applied:

Emission	EN 55022	(1998, Class A)
Harmonic	EN 61000-3-2	(1995 + A1:1998 +A2:1998)
Flicker	EN 61000-3-3	(1995)
Immunity	EN 55024	(1998)
ESD	IEC 61000-4-2	(1995)
RS	IEC 61000-4-3	(1995)
EFT/ Burst	IEC 61000-4-4	(1995)
Surge	IEC 61000-4-5	(1995)
CS	IEC 61000-4-6	(1996)
Magnetic Field	IEC 61000-4-8	(1993)
Voltage Disp	IEC 61000-4-11	(1994)

Responsible for marking this declaration if the:

Manufacturer  Authorized representative established within the EU

Authorized representative established within the EU (if applicable):

Company Name: **Planet Technology Corp.**

Company Address: **11F, No.96, Min Chuan Road, Hsin Tien, Taipei, Taiwan, R.O.C**

Person responsible for making this declaration

Name, Surname **Tom Shih**

Position / Title : **Product Manager**

Taiwan

Place

17, Sep., 2003

Date

Legal Signature

**PLANET TECHNOLOGY CORPORATION**

e-mail: sales@planet.com.tw http://www.planet.com.tw

11F, No. 96, Min Chuan Road, Hsin Tien, Taipei, Taiwan, R.O.C. Tel:886-2-2219-9518 Fax:886-2-2219-9528