

# User's Manual



## 2-Port GEPON Managed OLT

▶ EPL-2000



## Trademarks

Copyright © PLANET Technology Corp. 2016.

Contents are subject to revision without prior notice.

PLANET is a registered trademark of PLANET Technology Corp. All other trademarks belong to their respective owners.

## Disclaimer

PLANET Technology does not warrant that the hardware will work properly in all environments and applications, and makes no warranty and representation, either implied or expressed, with respect to the quality, performance, merchantability, or fitness for a particular purpose. PLANET has made every effort to ensure that this User's Manual is accurate; PLANET disclaims liability for any inaccuracies or omissions that may have occurred.

Information in this User's Manual is subject to change without notice and does not represent a commitment on the part of PLANET. PLANET assumes no responsibility for any inaccuracies that may be contained in this User's Manual. PLANET makes no commitment to update or keep current the information in this User's Manual, and reserves the right to make improvements to this User's Manual and/or to the products described in this User's Manual at any time without notice.

If you find information in this manual that is incorrect, misleading, or incomplete, we would appreciate your comments and suggestions.

## FCC Warning

This equipment has been tested and found to comply with the limits for a Class A digital device, pursuant to Part 15 of the FCC Rules. These limits are designed to provide reasonable protection against harmful interference when the equipment is operated in a commercial environment. This equipment generates, uses, and can radiate radio frequency energy and, if not installed and used in accordance with the Instruction manual, may cause harmful interference to radio communications. Operation of this equipment in a residential area is likely to cause harmful interference in which case the user will be required to correct the interference at whose own expense.

## CE Mark Warning

This is a Class A product. In a domestic environment, this product may cause radio interference, in which case the user may be required to take adequate measures.

## Energy Saving Note of the Device

This power required device does not support Standby mode operation. For energy saving, please remove the power cable to disconnect the device from the power circuit. Without removing power cable, the device will still consume power from the power source. In view of Saving the Energy and reducing the unnecessary power consumption, it is strongly suggested to remove the power connection for the device if this device is not intended to be active.

## WEEE Warning



To avoid the potential effects on the environment and human health as a result of the presence of hazardous substances in electrical and electronic equipment, end users of electrical and electronic equipment should understand the meaning of the crossed-out wheeled bin symbol. Do not dispose of WEEE as unsorted municipal waste and have to collect such WEEE separately.

## Revision

PLANET GEPON OLT (2-PON Interface, 2 x GbE SFP, 1 x MGT Port) User's manual

**MODEL:** EPL-2000

**REVISION:** 1.4 (June, 2016)

**Part No.:** EM-EPL-2000 (2081-BA0080-004)

## TABLE OF CONTENTS

<b>1. INTRODUCTION.....</b>	<b>5</b>
1.1 Packet Contents .....	5
1.2 Product Description .....	6
1.3 How to Use This Manual .....	7
1.4 Product Features .....	7
1.5 Product Specifications .....	9
<b>2. HARDWARE INSTALLATION .....</b>	<b>10</b>
2.1 Hardware Description .....	10
2.1.1 OLT Front Panel .....	10
2.1.2 LED Indications .....	11
2.1.3 OLT Rear Panel .....	12
2.2 Installing the OLT .....	12
2.2.1 Rack Mounting.....	12
2.2.2 Installing the SFP Transceiver .....	14
<b>3. MANAGEMENT SOFTWARE INSTALLATION .....</b>	<b>17</b>
3.1 Requirements.....	17
3.2 Management Access Overview .....	18
3.3 EMS Utility Management.....	18
3.3.1 MySQL Server Installation .....	19
3.3.2 EMS Utility Installation .....	28
3.3.3 Starting PLANET EMS Management .....	30
3.4 SNMP-based Network Management .....	31
<b>4. EMS Management System .....</b>	<b>32</b>
4.1 EMS Toolbar.....	33
4.1.1 System:.....	33
4.1.2 Alarm: .....	36
4.1.3 Config .....	40
4.1.4 Performance .....	41
4.1.5 Help .....	41
4.2 OLT Management.....	43
4.2.1 System Basic Information .....	45

4.2.2 Basic Information .....	46
4.2.3 Net Interface Management .....	47
4.2.4 User Manage .....	48
4.2.5 IGMPSetting .....	49
4.2.6 Trunk Management.....	50
4.2.7 VLAN Management .....	51
4.2.8 IPTV Profile .....	57
4.2.9 IPTV Channel .....	58
4.2.10 Port Property .....	59
4.2.11 Port Status .....	61
<b>4.3 PON Card Management .....</b>	<b>62</b>
4.3.1 Interface Information.....	62
4.3.2 OLT Global Setting .....	64
4.3.3 ONU Auth .....	65
<b>4.4 ONU Management .....</b>	<b>66</b>
4.4.1 Basic Configuration .....	67
4.4.2 Global Parameter .....	68
4.4.3 ONU Multicast Group .....	69
4.4.4 DBA Configuration .....	70
4.4.5 ONU Port Management .....	71
4.4.6 Port Multicast.....	72
4.4.7 ONU VLAN .....	73
4.4.8 Port Policing.....	74
4.4.9 Port Egress.....	75
<b>4.5 How to upgrade EPL-2000 firmware.....</b>	<b>76</b>
<b>5. EPL-2000 OPERATION .....</b>	<b>80</b>
5.1 Address Table .....	80
5.2 Learning .....	80
5.3 Forwarding & Filtering .....	80
5.4 Auto-Negotiation .....	80
<b>APPENDIX A .....</b>	<b>81</b>
A.1 Switch's RJ45 Pin Assignments.....	81
A.2 10/100Mbps, 10/100BASE-TX.....	81

# 1. INTRODUCTION

PLANET EPL-2000 is a GEAPON Optical Line Terminal (OLT), consisting of two GEAPON ports, two Gigabit SFP Interfaces and one management port. The term “**GEAPON OLT**” refers to the OLT in this user's manual.

## 1.1 Packet Contents

The box should contain the following items:

- |   |     |
|---|-----|
| <input checked="" type="checkbox"/> <b>GEAPON OLT</b>                   | x 1 |
| <input checked="" type="checkbox"/> <b>MGB-PX20 SFP Transceivers</b>    | x 2 |
| <input checked="" type="checkbox"/> <b>Quick Installation Guide</b>     | x 1 |
| <input checked="" type="checkbox"/> <b>19” Rack Mount Accessory Kit</b> | x 1 |
| <input checked="" type="checkbox"/> <b>AC Power Cord</b>                | x 1 |

If any of these are missing or damaged, please contact your dealer immediately; if possible, retain the carton including the original packing material, and use them again to repack the product in case there is a need to return it to us for repair.

## 1.2 Product Description



### Perfectly Designed for FTTx Applications

PLANET EPL-2000 is a GEAPON **Optical Line Terminal (OLT)**, consisting of two GEAPON ports, two Gigabit SFP Interfaces and one management port. It is easy to install and maintain the GEAPON deployment. Working with PLANET GEAPON **Optical Network Units (ONU)** EPN series, PLANET EPL-2000 can provide highly-effective GEAPON solutions and convenient management for broadband network. PLANET GEAPON technology provides a high bandwidth of up to 1.25Gbps for both upstream and downstream, long-distance coverage of up to 20km between equipment nodes, and scalability and flexibility in network deployment. It is a cost-effective access technology with reliable and scalable network for Tripleplay service applications.

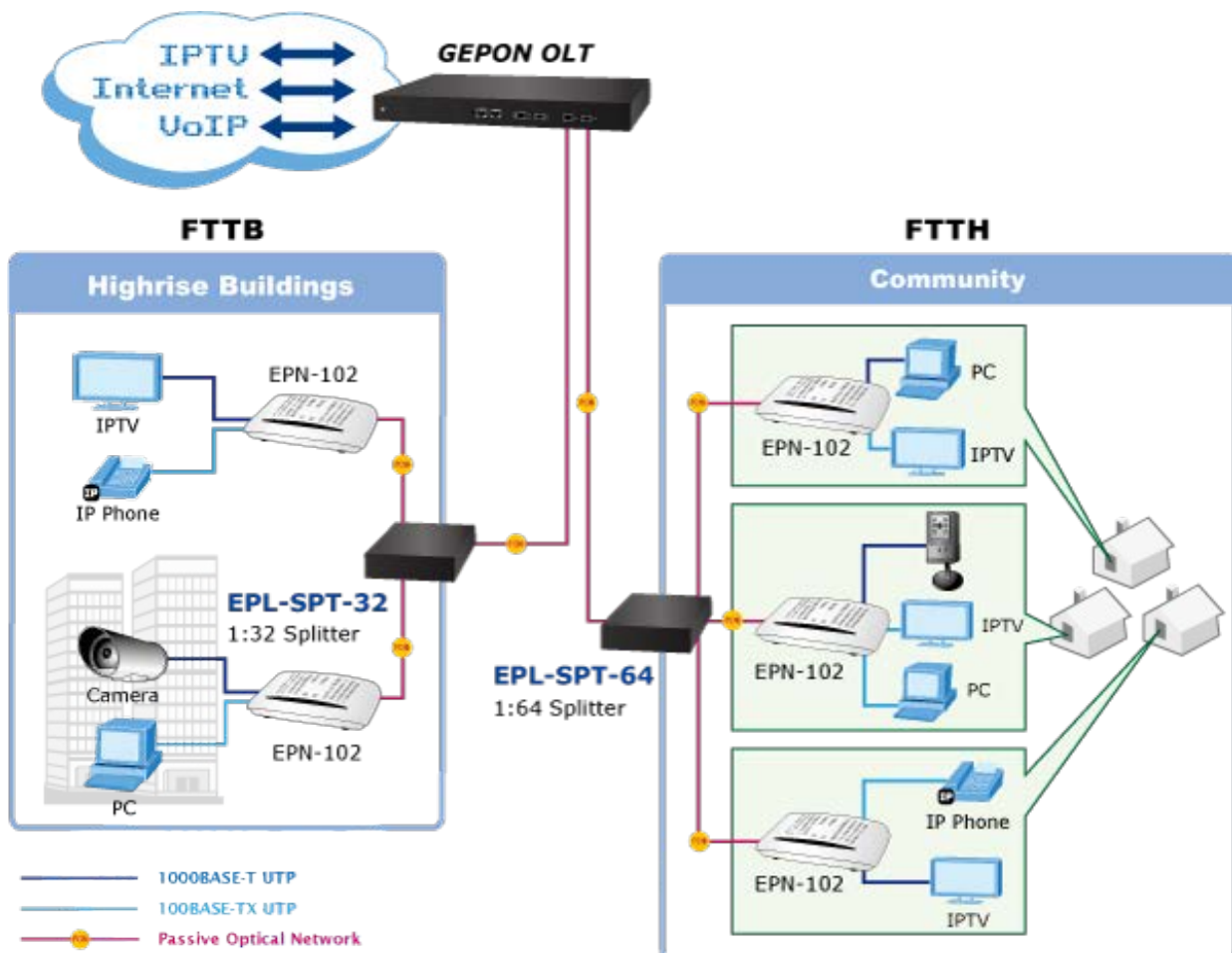

## High-speed Connectivity for ISP/Tripleplay Devices

With the growing network services such as HDTV, IPTV, voice-over-IP (VoIP) and multimedia broadband applications, the demand for broadband has increased quickly. The present broadband environment has not met the market needs; however, **Passive Optical Network (PON)** would be the most promising NGN (Next Generation Networking) technology to fulfill the demand.

## Robust Layer 2 Features

With a high-split ratio of 1:64 and supporting the usage of PLANET ONUs, the EPL-2000 can minimize the investment cost for carriers. By using the advanced technology in the telecommunication industry, the EPL-2000 provides strong functionalities for Ethernet features such as VLAN, Multicast, DBA (Dynamic Bandwidth Allocation), and Access Control List. The EPL-2000 is an ideal solution for FTTx applications.

GEPON is a point to multipoint communications protocol based on Gigabit Ethernet. It allows a Gigabit Ethernet communications fiber to be shared by multiple end users using a passive optical splitter. GEPON communication takes place between an Optical Line Terminal (OLT) and multiple Optical Network Units (ONUs). Using standard terminology, downstream traffic flows from OLT to ONU, and upstream traffic flows from ONU to OLT. A protocol called Multi Point Control Protocol (MPCP) is used to arbitrate the channel between the ONU's so that no collisions will occur on the common fiber.

## 1.3 How to Use This Manual

This User Manual is structured as follows:

### Section 2, Hardware INSTALLATION

The section explains the functions of the Switch and how to physically install the GEPON OLT.

### Section 3, EMS Utility INSTALLATION

The section contains the information about how to install EMS Utility.

### Section 4, EMS Utility CONFIGURATION

The section explains how to manage the GEPON OLT by EMS Utility.

### Section 5, SWITCH OPERATION

The chapter explains how to do the switch operation of the GEPON OLT.

### Appendix A

The section contains cable information of the GEPON OLT.

## 1.4 Product Features

- **GEPON Port**
  - 2 x SC type GEPON OLT port
  - Up to 1.25Gbps for upstream and downstream speed
  - Maximum transfer distance of up to 20km
  - Each OLT port supports up to 64 ONUs
  - Fully compliant with IEEE 802.3ah
  - Point-to-multipoint network topology
  - LED indicators for link status

- **Uplink and Management Port**
  - 2 x 1000BASE-SX/LX SFP interface
  - Maximum transfer distance of up to 120km
  - 1 x 10/100BASE-TX RJ45 management port
- **Layer 2 Features**
  - Dynamic bandwidth allocation (DBA) support
  - Supports VLAN
    - IEEE 802.1Q tagged VLAN
    - Up to 255 VLAN groups, out of 4094 VLAN ID
  - Supports up to 8K MAC Address Table
  - Enhanced IGMP features
  - Supports Link Aggregation on two uplink ports
- **OLT Management**
  - User-friendly GUI Management
  - IPTV multicast creation and management
  - Up to 32 OLTs management through single GUI
  - SNMP v1/v2c monitoring
  - Three users levels control
  - 2 control interfaces
    - Out-of-band IP via the Management RJ45 port
    - In-band IP via the two uplink ports
  - Supports ONU authentication; averts illegal ONUs access to network
  - Event message logging to system log
  - SNMP trap for alarm notification
- **ONU Management**
  - ONU Port control
  - ONU Multicast control
  - ONU IGMP fastleave
  - ONU VLAN mode



## 1.5 Product Specifications

<b>Product</b>		<b>EPL-2000</b>
<b>Hardware Specifications</b>		
<b>Transmission Speed</b>		Downstream: 1.25 Gbps Upstream: 1.25 Gbps
<b>Optical Split Ratio</b>		Up to 1:64
<b>Port</b>	<b>Uplink Port</b>	2 x 1000BASE-X SFP slot
	<b>PON Port</b>	2 x PON Port
	<b>MGMT Port</b>	1 x RJ45 (10/100BASE-TX)
<b>LED Indicators</b>		1 x Power LED 1 x System LED 4 x Uplink Port LED (ACT and Link) 2 x PON LED (Link)
<b>EMS Utility Specifications</b>		
<b>Switch Feature</b>		IPTV multicast creation and management MAC address learning and binding MAC filtering Supports IGMP mode Supports the VLAN division on the basis of port Up to 4094 VLAN support 8K MAC Addresses support ONU Multicast control ONU IGMP fastleave ONU VLAN mode ONU Port Management
<b>Management</b>		User-friendly GUI Utility Firmware and Configuration upgradeable via Utility Remote ONU Management
<b>Standards Conformance</b>		
<b>Safety</b>		FCC Part 15 Class A, CE
<b>Standards Compliance</b>		IEEE 802.3 10BASE-T IEEE 802.3u 100BASE-TX IEEE 802.3z Gigabit SX/LX IEEE 802.3x Flow Control and Back pressure IEEE 802.1Q VLAN Tagging
<b>Environment Specifications</b>		
<b>Dimensions (W x D x H)</b>		441 x 206 x 44mm
<b>Weight</b>		2.31kg
<b>Power</b>		100 – 250V AC
<b>Temperature</b>		Operating temperature: 0 ~ 50 degrees C Storage temperature: -30 ~ 60 degrees C
<b>Humidity</b>		Operating Humidity: 10 ~ 90% non-condensing Storage Humidity: 5 ~ 95% non-condensing

## 2. HARDWARE INSTALLATION

This section describes the hardware features and installation of the GEAPON OLT on the desktop or rack mount. For easier management and control of the GEAPON OLT, familiarize yourself with its display indicators and ports. Front panel illustrations in this chapter display the unit LED indicators. Before connecting any network device to the GEAPON OLT, please read this chapter completely.

### 2.1 Hardware Description

#### 2.1.1 OLT Front Panel

The unit front panel provides a simple interface monitoring the OLT. [Figure 2-1](#) shows the front panel of the GEAPON OLT.

##### EPL-2000 Front Panel

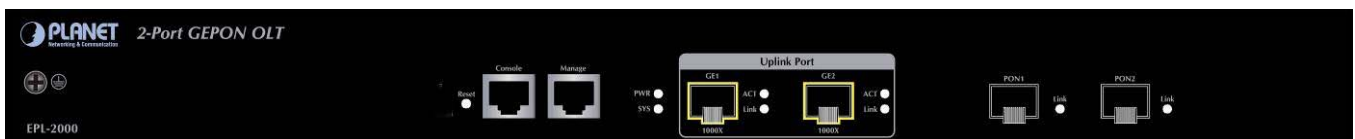

Figure 2-1 EPL-2000 Front Panel

##### Reset Button

The reset button is designed for rebooting the GEAPON OLT without turning off and on the power. The following is the summary table of reset button functions:

Reset Button Pressed and Released	Function
System reboot	Reboot the GEAPON OLT

##### Management Port

10/100BASE-TX copper, RJ45 twisted-pair: Up to 100 meters

##### Gigabit SFP Uplink Slots

1000BASE-SX/LX mini-GBIC slot, SFP (Small Form Factor Pluggable) transceiver module: From 550 meters (multi-mode fiber) to 10/30/50/70/120 kilometers (single-mode fiber).



GE1 and GE2 Gigabit SFP uplink slots support **1000Mbps Forced Mode** only. The remote Gigabit switch or media converter's SFP port must support 1000Mbps Forced Mode as well.

##### Gigabit SFP PON Slots

1000BASE-PX20 mini-GBIC slot, SFP (Small Form Factor Pluggable) transceiver module: Up to 20 kilometers (single-mode fiber).

## 2.1.2 LED Indications

The front panel LEDs indicate instant status of port links, data activity and system power, and help to monitor and troubleshoot when needed. Figure 2-2 shows the LED indications of these GEAPON OLTs.

### EPL-2000 LED Indication

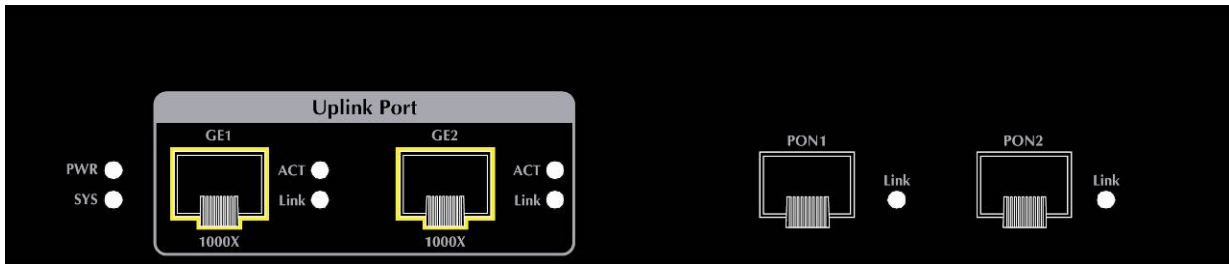

Figure 2-2 EPL-2000 LED Panel

#### ■ System

LED	Color	Function
PWR	Green	<b>Lights:</b> To indicate that the Switch is powered on.
SYS	Green	<b>Blink:</b> The OLT is ready for management
		<b>Off:</b> The OLT is abnormal in system operation

#### ■ 1000BASE-SX/LX SFP interfaces (GE1 and GE2 Ports)

LED	Color	Function
LINK	Green	<b>Lights:</b> To indicate the link through that SFP port is successfully established.
		<b>Off:</b> To indicate that the SFP port is link-down.
ACT	Green	<b>Blink:</b> To indicate that the switch is actively sending or receiving data over that port.

#### ■ 1000BASE-PX20 SFP PON interfaces (PON1 and PON2 Ports)

LED	Color	Function
LINK	Green	<b>Lights:</b> To indicate the link through that PON port is successfully established.
		<b>Off:</b> To indicate that the PON port is link-down.

## 2.1.3 OLT Rear Panel

The rear panel of the GEPON OLT indicates an AC inlet power socket, which accepts input power from 100 to 250V AC, 50-60Hz. [Figure 2-3](#) shows the rear panel of this GEPON OLT.

### EPL-2000 Rear Panel

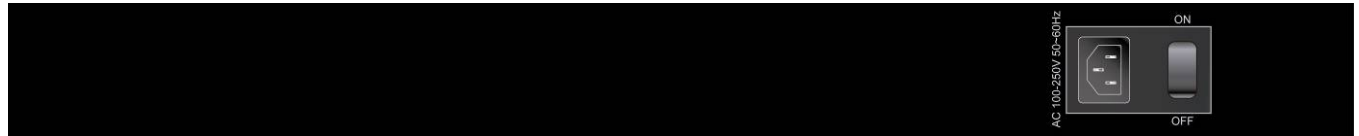

**Figure 2-3** Rear Panel of EPL-2000

#### ■ AC Power Receptacle

For compatibility with electric service in most areas of the world, the GEPON OLT's power supply automatically adjusts to line power in the range of 100-250V AC and 50/60 Hz.

Plug the female end of the power cord firmly into the receptacle on the rear panel of the GEPON OLT and the other end of the power cord into an electric outlet and then the power will be ready.

There is a power switch for AC power input use only, whereas DC power input has no power switch.



---

The device is a power-required device; if your networks should be active all the time, please consider using UPS (Uninterrupted Power Supply) for your device. It will prevent you from network data loss or network downtime.

In some areas, installing a surge suppression device may also help to protect your GEPON OLT from being damaged by unregulated surge or current to the switch or the power adapter.

---

## 2.2 Installing the OLT

This section describes how to install your GEPON OLT and make connections to the GEPON OLT. Please read the following topics and perform the procedures in the order being presented. To install your GEPON OLT on a shelf, simply complete the following steps.

### 2.2.1 Rack Mounting

To install the GEPON OLT in a 19-inch standard rack, please follow the instructions described below:

**Step 1:** Place the GEPON OLT on a hard flat surface, with the front panel positioned towards the front side.

**Step 2:** Attach the rack-mount bracket to each side of the GEPON OLT with supplied screws attached to the package.

[Figure 2-4](#) shows how to attach brackets to one side of the GEPON OLT.

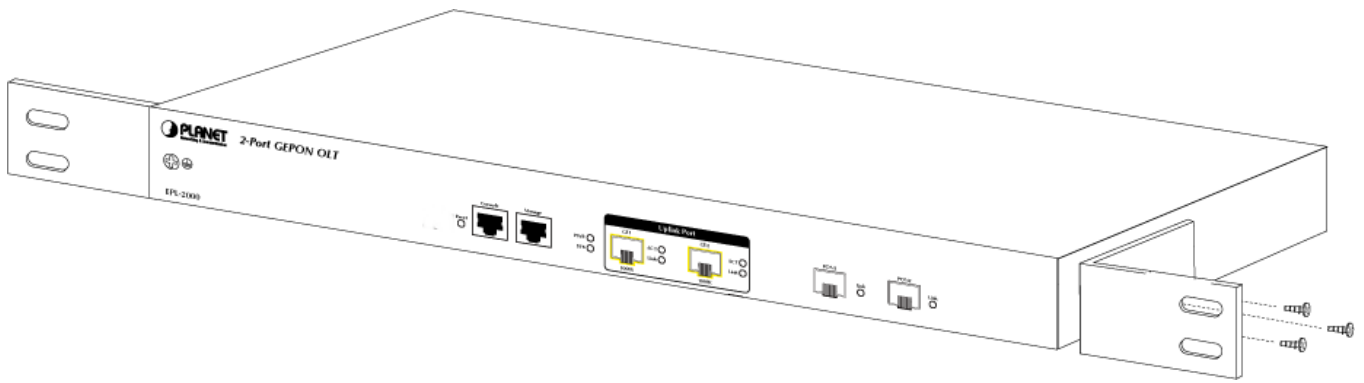

Figure 2-4 Attaching Brackets to the GEAPON OLT.



You must use the screws supplied with the mounting brackets. Damage caused to the parts by using incorrect screws would invalidate the warranty.

**Step 3:** Secure the brackets tightly.

**Step 4:** Follow the same steps to attach the second bracket to the opposite side.

**Step 5:** After the brackets are attached to the GEAPON OLT, use suitable screws to securely attach the brackets to the rack, as shown in Figure 2-5.

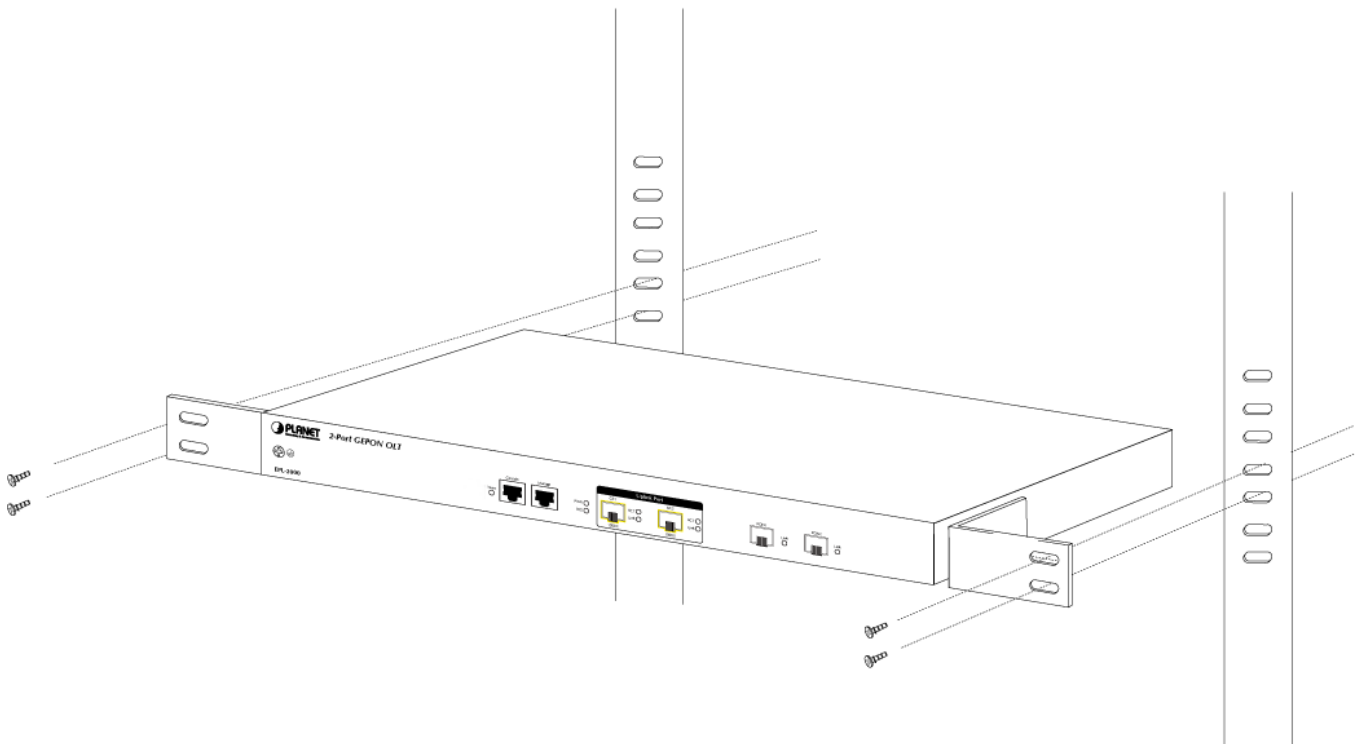

Figure 2-5 Mounting the GEAPON OLT on a Rack

## 2.2.2 Installing the SFP Transceiver

The sections describe how to insert an SFP transceiver into an SFP slot. The SFP transceivers are hot-pluggable and hot-swappable. You can plug in and out the transceiver to/from any SFP port without having to power down the GEPON OLT as Figure 2-6 shows.

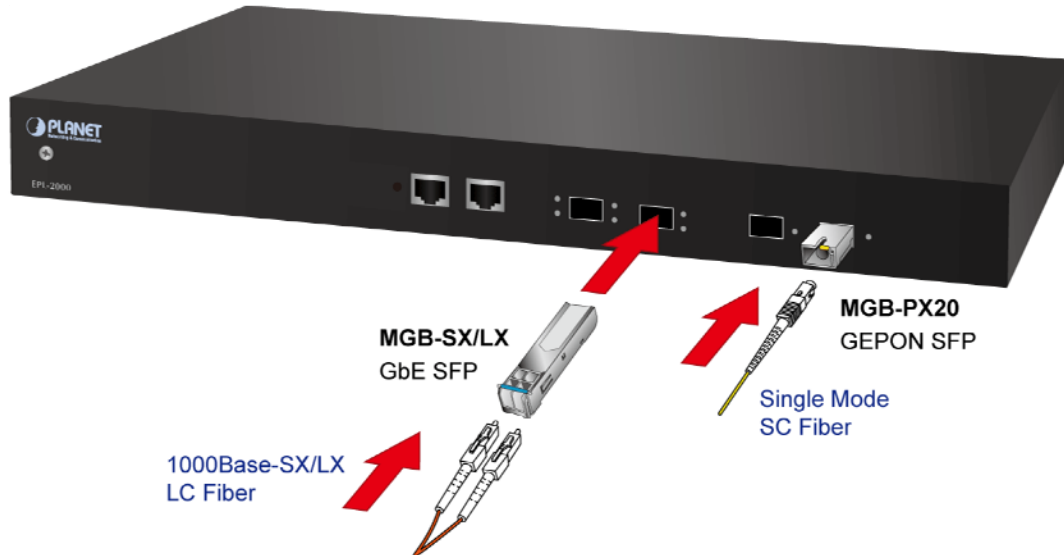

Figure 2-6 Plugging in the SFP Transceiver

### ■ Approved PLANET SFP Transceivers

PLANET GEPON OLT supports both Single mode and Multi-mode SFP transceivers. The following list of approved PLANET SFP transceivers is correct at the time of publication:

#### 1000BASE-X SFP modules:

##### Gigabit Ethernet Transceiver (1000BASE-X SFP)

Model	Speed (Mbps)	Connector Interface	Fiber Mode	Distance	Wavelength (nm)	Operating Temp.
MGB-GT	1000	Copper	--	100m	--	0 ~ 60 °C
MGB-SX	1000	LC	Multi Mode	550m	850nm	0 ~ 60 °C
MGB-SX2	1000	LC	Multi Mode	2km	1310nm	0 ~ 60 °C
MGB-LX	1000	LC	Single Mode	10km	1310nm	0 ~ 60 °C
MGB-L30	1000	LC	Single Mode	30km	1310nm	0 ~ 60 °C
MGB-L50	1000	LC	Single Mode	50km	1550nm	0 ~ 60 °C
MGB-L70	1000	LC	Single Mode	70km	1550nm	0 ~ 60 °C
MGB-L120	1000	LC	Single Mode	120km	1550nm	0 ~ 60 °C
MGB-TSX	1000	LC	Multi Mode	550m	850nm	-40 ~ 75 °C
MGB-TLX	1000	LC	Single Mode	10km	1310nm	-40 ~ 75 °C
MGB-TL30	1000	LC	Single Mode	30km	1310nm	-40 ~ 75 °C
MGB-TL70	1000	LC	Single Mode	70km	1550nm	-40 ~ 75 °C

**Gigabit Ethernet Transceiver (1000BASE-BX, Single Fiber Bi-directional SFP)**

Model	Speed (Mbps)	Connector Interface	Fiber Mode	Distance	Wavelength (TX)	Wavelength (RX)	Operating Temp.
MGB-LA10	1000	WDM(LC)	Single Mode	10km	1310nm	1550nm	0 ~ 60 °C
MGB-LB10	1000	WDM(LC)	Single Mode	10km	1550nm	1310nm	0 ~ 60 °C
MGB-LA20	1000	WDM(LC)	Single Mode	20km	1310nm	1550nm	0 ~ 60 °C
MGB-LB20	1000	WDM(LC)	Single Mode	20km	1550nm	1310nm	0 ~ 60 °C
MGB-LA40	1000	WDM(LC)	Single Mode	40km	1310nm	1550nm	0 ~ 60 °C
MGB-LB40	1000	WDM(LC)	Single Mode	40km	1550nm	1310nm	0 ~ 60 °C
MGB-LA60	1000	WDM(LC)	Single Mode	60km	1310nm	1550nm	0 ~ 60 °C
MGB-LB60	1000	WDM(LC)	Single Mode	60km	1550nm	1310nm	0 ~ 60 °C
MGB-TLA10	1000	WDM(LC)	Single Mode	10km	1310nm	1550nm	-40 ~ 75 °C
MGB-TLB10	1000	WDM(LC)	Single Mode	10km	1550nm	1310nm	-40 ~ 75 °C
MGB-TLA20	1000	WDM(LC)	Single Mode	20km	1310nm	1550nm	-40 ~ 75 °C
MGB-TLB20	1000	WDM(LC)	Single Mode	20km	1550nm	1310nm	-40 ~ 75 °C
MGB-TLA40	1000	WDM(LC)	Single Mode	40km	1310nm	1550nm	-40 ~ 75 °C
MGB-TLB40	1000	WDM(LC)	Single Mode	40km	1550nm	1310nm	-40 ~ 75 °C
MGB-TLA60	1000	WDM(LC)	Single Mode	60km	1310nm	1550nm	-40 ~ 75 °C
MGB-TLB60	1000	WDM(LC)	Single Mode	60km	1550nm	1310nm	-40 ~ 75 °C



**GEPON OLT EPL-2000 SFP ports of GE1 and GE2 are configured in 1000Mbps Forced Mode. If want to make the connection successfully, the switch's SFP ports should also be in 1000Mbps Forced Mode. Otherwise, the connection might fail.**

Before connecting the other GEPON OLT, workstation or media converter,

1. Make sure both sides of the SFP transceiver are with the same media type, for example, 1000BASE-SX to 1000BASE-SX, 1000Bas-LX to 1000BASE-LX.
2. Check whether the fiber-optic cable type matches the SFP transceiver model.
  - To connect to 1000BASE-SX SFP transceiver, use the multi-mode fiber cable, with one side being male duplex LC connector type.
  - To connect to 1000BASE-LX SFP transceiver, use the single-mode fiber cable, with one side being male duplex LC connector type.

#### ■ Connecting the fiber cable

1. Insert the duplex LC connector on the network cable into the SFP transceiver.
2. Connect the other end of the cable to a device – switches with SFP installed, fiber NIC on a workstation or a media converter.
3. Check the LNK/ACT LED of the SFP slot on the front of the GEPON OLT. Ensure that the SFP transceiver is operating correctly.
4. Check the Link mode of the SFP port if the link fails. Works well with some fiber-NICs or media converters. Set the Link mode to “1000 Force” if needed.

■ **Removing the transceiver module**

1. Make sure there is no network activity by consulting or checking with the network administrator. Or through the management interface of the switch/converter (if available), disable the port in advance.
2. Remove the Fiber Optic Cable gently.
3. Turn the handle of the MGB module to a horizontal position.
4. Pull out the module gently through the handle.



**Figure 2-8** Pulling Out the SFP Transceiver



Never pull out the module without pulling the handle or the push bolts on the module. Directly pulling out the module with force could damage the module and SFP module slot of the GEAPON OLT.



## 3. MANAGEMENT SOFTWARE INSTALLATION

This chapter explains the methods that you can use to configure management access to the GEAPON OLT. It describes the types of management applications and the communication and management protocols that deliver data between your management device (workstation or personal computer) and the system. It also contains information about port connection options.

**This chapter covers the following topics:**

- Requirements
- Management Access Overview
- MySQL Installation
- EMS Utility Installation
- SNMP Access

### 3.1 Requirements

The GEAPON OLT provides a GUI utility to manage the system; the following equipment is necessary for further management.

- Subscriber PC is installed with Ethernet NIC (Network Card)
- **MySQL** Software (Windows Platform) <http://dev.mysql.com/>
- **EMS** Software (Windows Platform)
- **Management Port** connection
  - Network cables -- Use standard network (UTP) cables with RJ45 connectors
- **PON Port** connection
  - Fiber Transceiver - Slot with a 1000BASE-PX20 SFP PON transceiver
  - Fiber Cable - Use single mode of Fiber (SC) cable

## 3.2 Management Access Overview

The GEAPON OLT EPL-2000 supports 10/100Mbps Management interface and two 1000BASE-X net interfaces for TCP/IP-based GUI Management. The GEAPON OLT gives you the flexibility to access and manage it by using any or all of the following methods:

- **EMS (Element Management System) Utility**
- An external **SNMP-based network management application**

Each of these management methods has their own advantages. Table 3-1 compares the two management methods.

Method	Advantages	Disadvantages
<b>EMS Utility</b>	<ul style="list-style-type: none"> <li>• Ideal for configuring the EPL-2000</li> <li>• Compatible with most popular Windows-based Systems</li> <li>• Most visually appealing</li> </ul>	<ul style="list-style-type: none"> <li>• Can't remote control over Etherent</li> </ul>
<b>SNMP Agent</b>	<ul style="list-style-type: none"> <li>• Communicates with switch functions at the MIB level</li> <li>• Based on open standards</li> </ul>	<ul style="list-style-type: none"> <li>• Requires SNMP manager software</li> <li>• Least visually appealing of all three methods</li> <li>• Some settings require calculations</li> <li>• Security can be compromised (hackers need only know the community name)</li> </ul>

**Table 3-1** Management Methods Comparison

## 3.3 EMS Utility Management

The **EMS (Element Management System) Utility** comes with sophisticated software Graphical User Interface (GUI). It is highly intuitive and allows the user to control the GEAPON and set such things as SLAs, bridging and VLAN modes, static table entries, and to perform firmware upgrades, etc. It is found in the Utility folder on the CD provided. There are two softwares that need to be installed in your management PC:

- Microsoft MySQL Server
- EMS Utility

To install and use the GUI, do the following two sections.

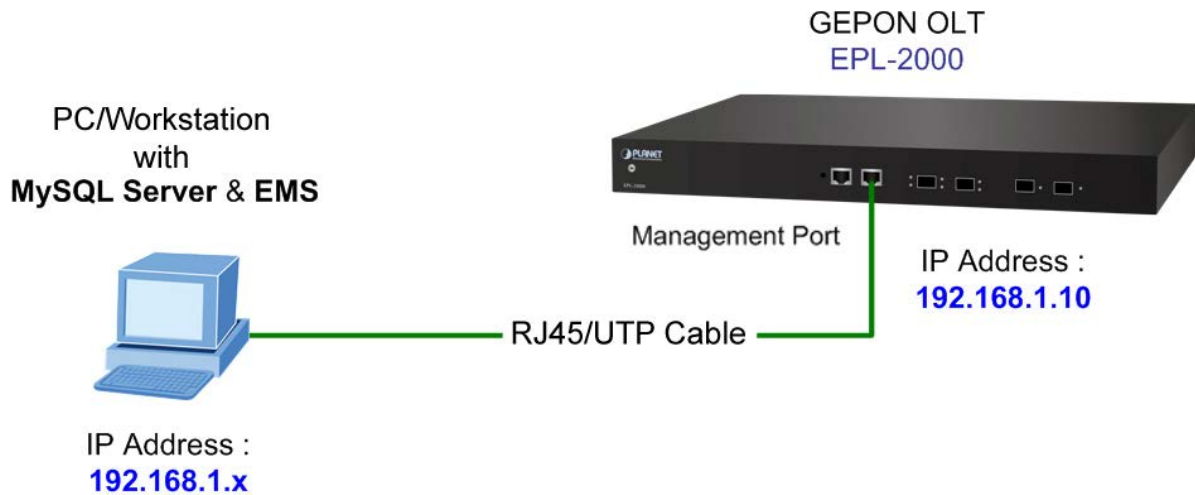

### 3.3.1 MySQL Server Installation

1. Please visit MySQL official website <http://dev.mysql.com/> and download MySQL-Essential-5.1.73-win32.msi or MySQL-Essential-5.1.73-win64.msi for the Windows system.
2. Once the Setup program starts running, please click the "Next" button for starting installation.



Figure 3-2 MySQL Installation Screen

- When the Setup Type window appears, choose the default "Typical" mode. Please click the "Next" button.

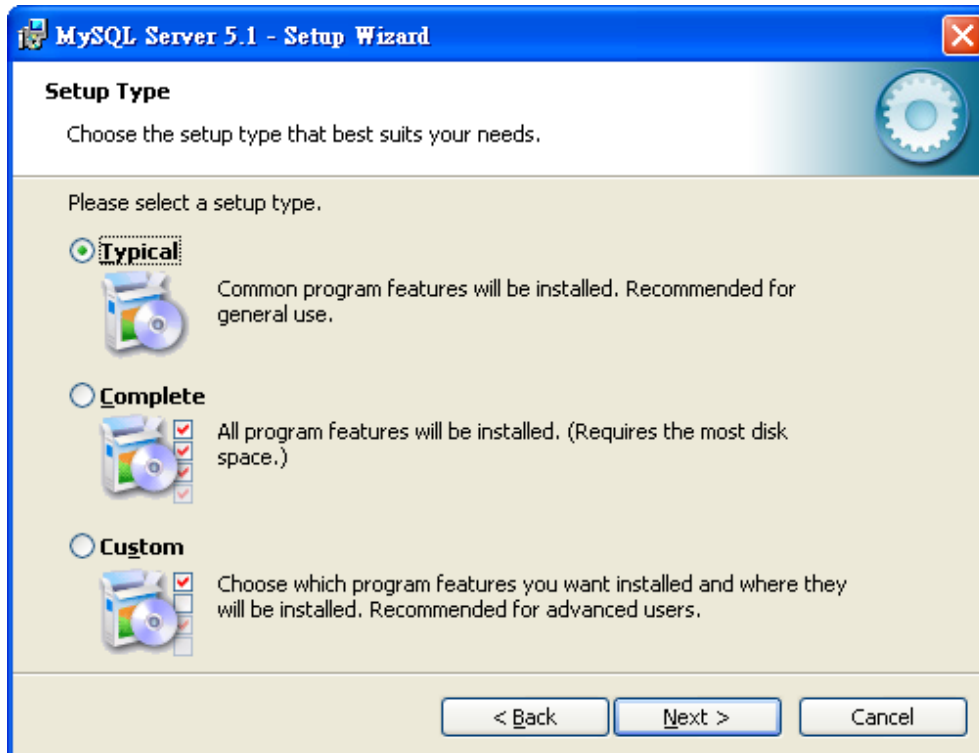

Figure 3-3 Setup Type Screen

- When the Ready to Install the Program window appears, please click the "Install" button.

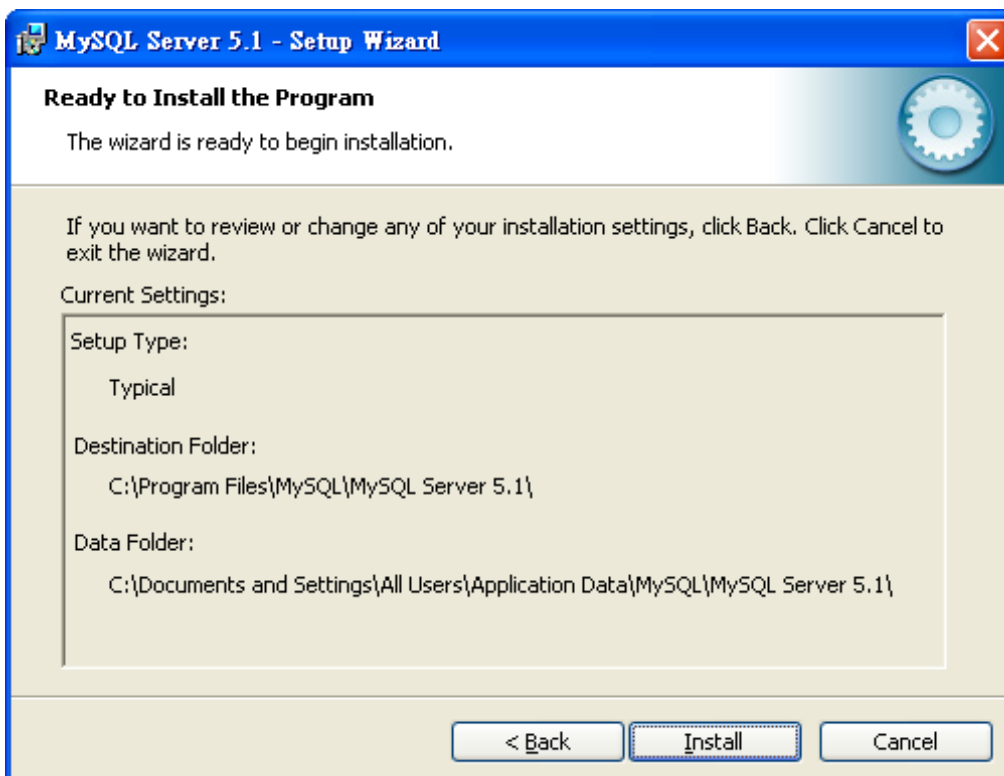

Figure 3-4 Begin Installation Wizard Screen

5. When the installation is done, the MySQL Enterprise window appears. Please click the **Next** button.



Figure 3-5 MySQL Enterprise Screen

6. The "Wizard Completed" window appears, and it will ask for Configure the MySQL server and Register the MySQL Server now. Please click the **Finish** button.



Figure 3-6 Wizard Completed Screen

- The MySQL Server Instance Configuration Wizard window appears; please click the **Next** button.

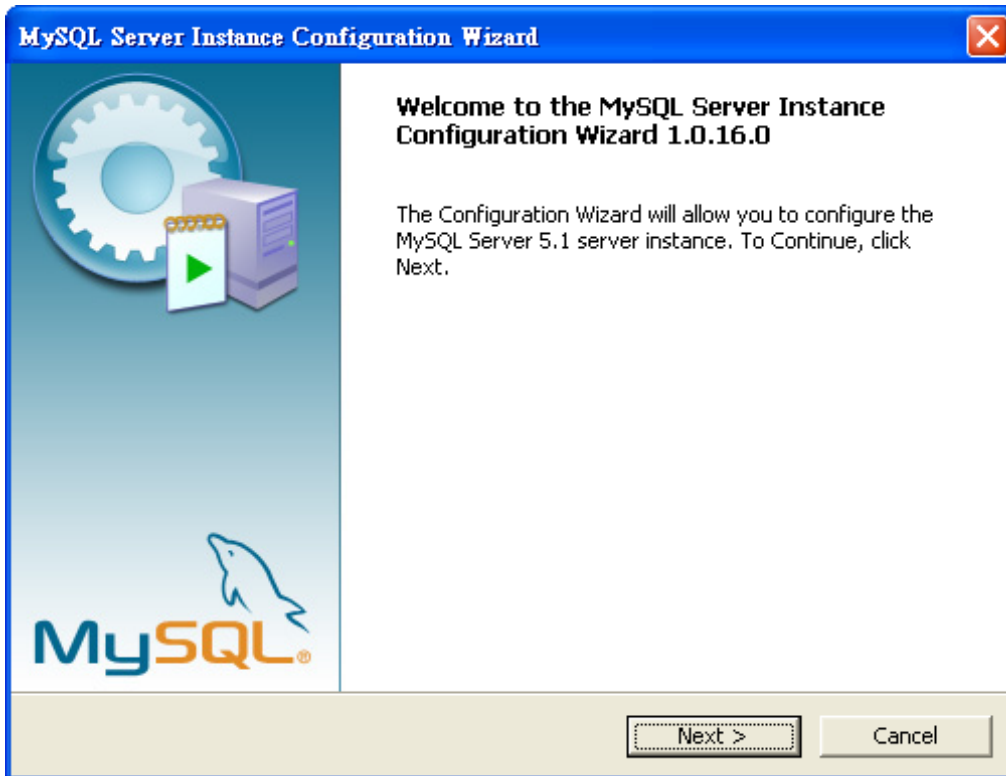

Figure 3-7 MySQL Configuration Wizard Screen

- The MySQL Server Instance Configuration window appears; keep the default setting of **Detailed Configuration** and click the **Next** button.

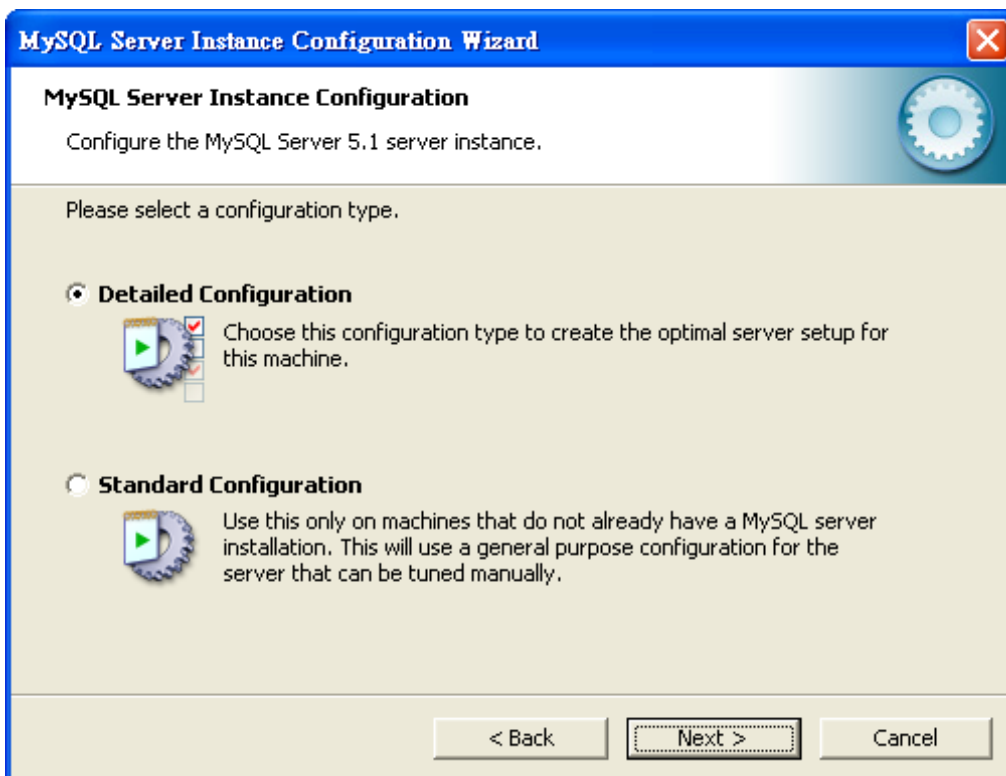

Figure 3-8 MySQL Server Instance Configuration (1) Screen

9. Please select a Server type. Keep the default setting of "Developer Machine" and click the "Next" button.



Figure 3-9 MySQL Server Instance Configuration (2) Screen

10. Please select the database usage. Keep the default setting of "Multifunctional Database" and click the "Next" button.

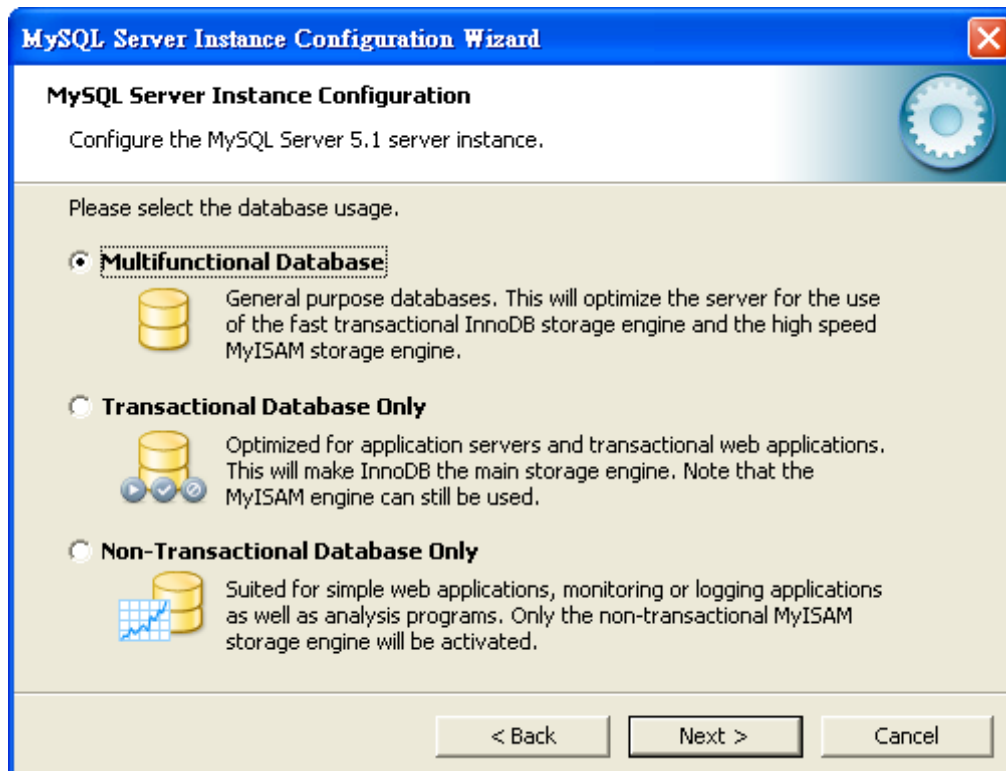

Figure 3-10 MySQL Server Instance Configuration (3) Screen

11. Choose where you want to place the InnoDB Datafile. Here is the remaining default setting. Please click the **Next** button.

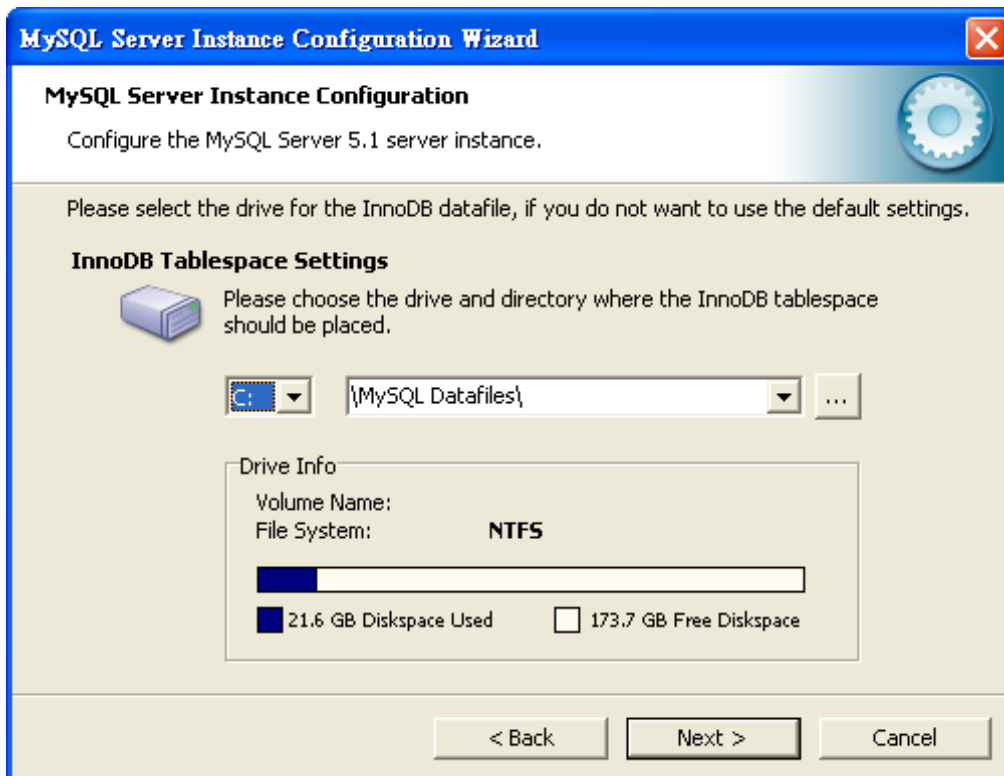

Figure 3-11 MySQL Server Instance Configuration (4) Screen

12. Please set the approximate number of concurrent connections. Keep the default setting of **Decision Support (DSS)/OLAP** and click the **Next** button.

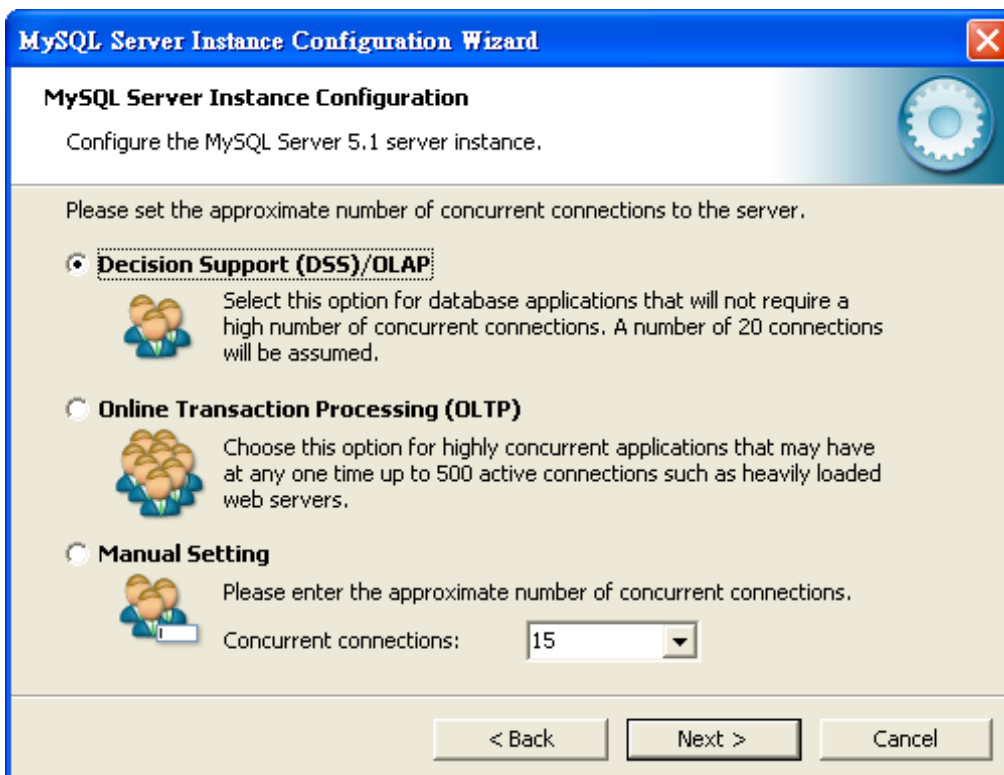

Figure 3-12 MySQL Server Instance Configuration (5) Screen



- Please set the Network options and Server SQL mode. Keep the default setting and click the "Next" button.

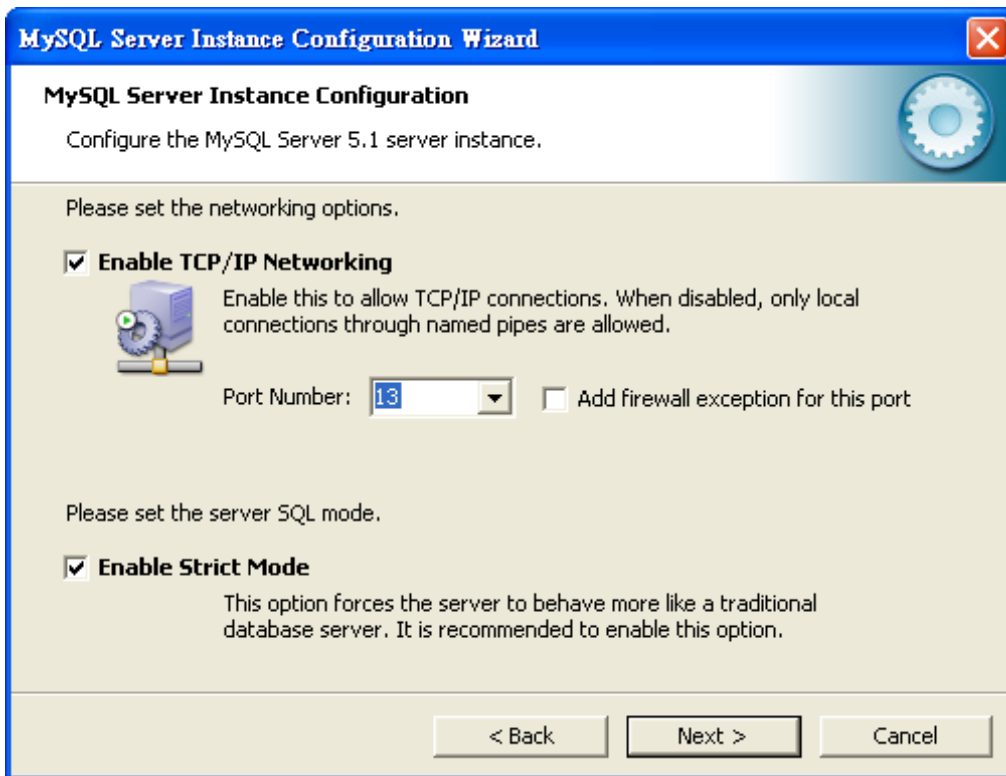

Figure 3-13 MySQL Server Instance Configuration (6) Screen

- Please select the default character set. Keep the default setting of "Standard Character Set" and click the "Next" button.

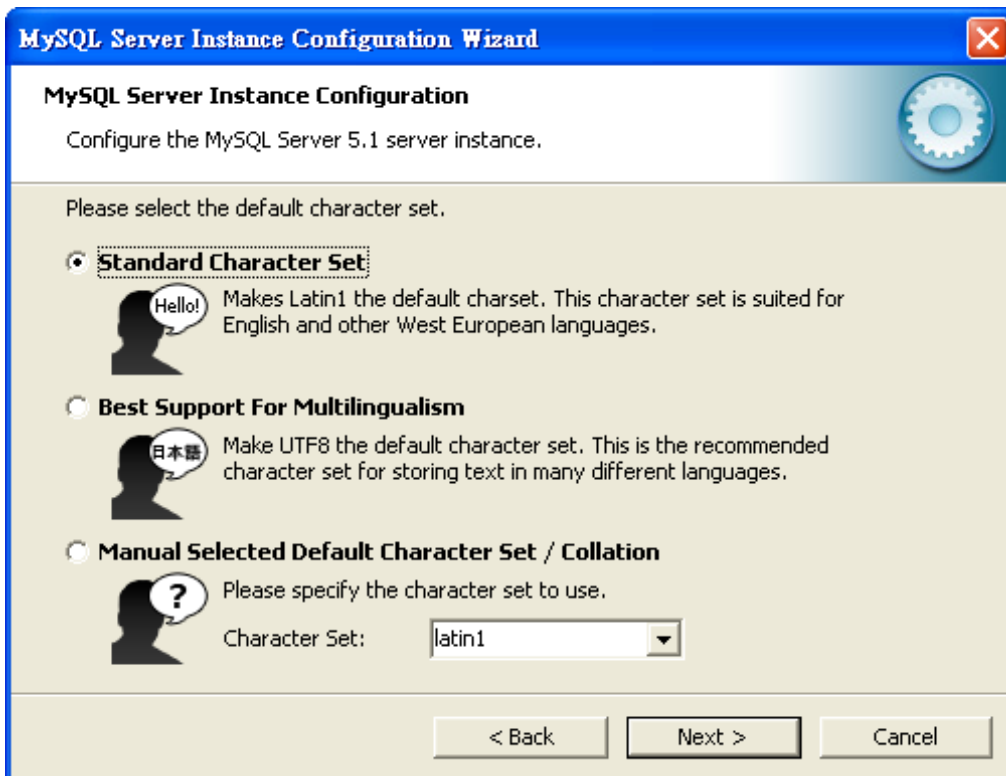

Figure 3-14 MySQL Server Instance Configuration (7) Screen

- Please set the Windows options. Keep default setting and click the "Next" button.



Figure 3-15 MySQL Server Instance Configuration (8) Screen

- Please set the security options. Type the password "1234" for the current root and new root. Click the "Next" button.



Figure 3-16 MySQL Server Instance Configuration (9) Screen

- Please click the **Execute** button for starting the configuration.

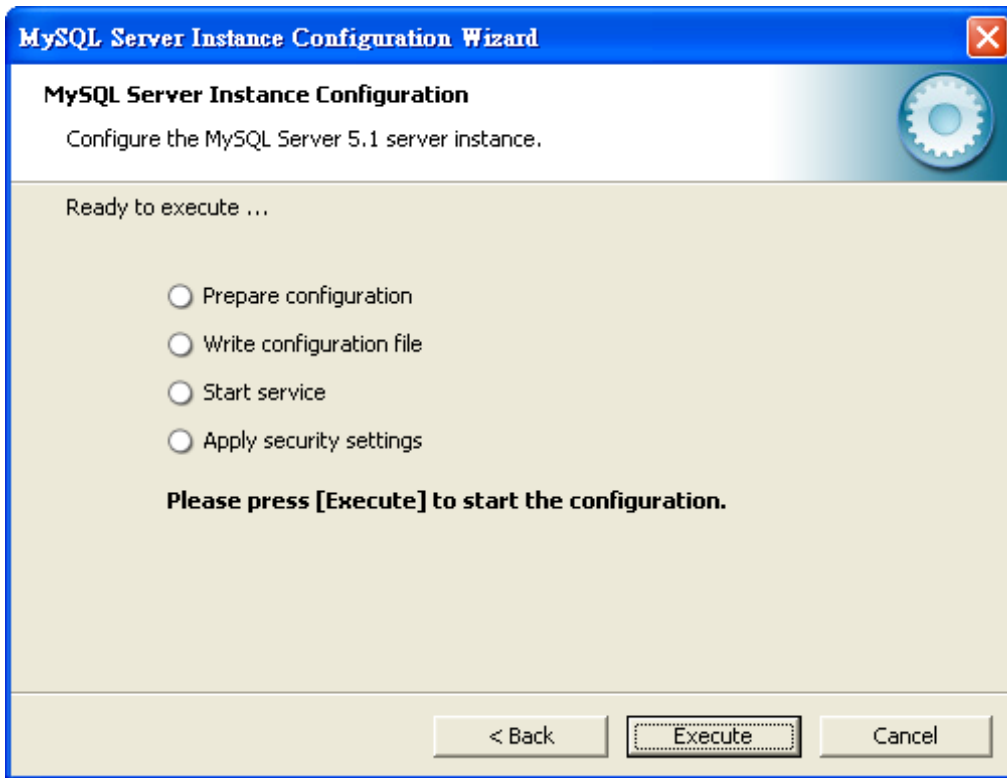

Figure 3-17 MySQL Server Instance Configuration (10) Screen

- Please give a check to "Configuration file created", "Windows service MySQL installed", "Service started successfully" and "Security applied", and then click the **Finish** button.

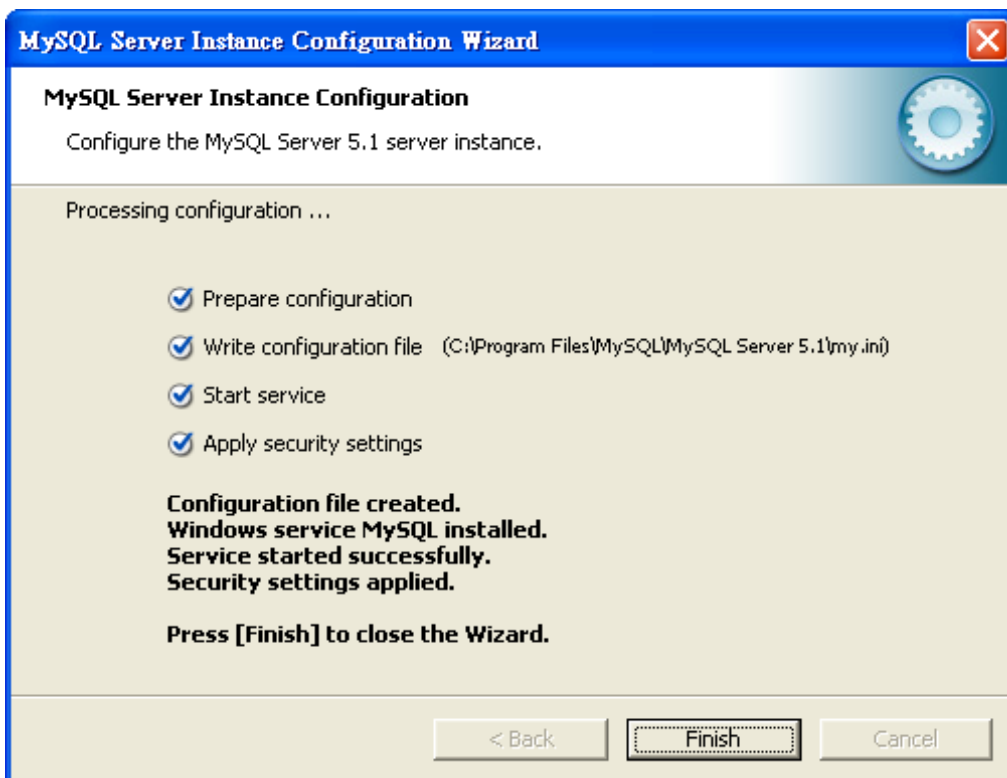

Figure 3-18 MySQL Server Finish Screen

### 3.3.2 EMS Utility Installation

1. Insert the bundled CD disk into the CD-ROM drive to launch the autorun program. Once completed, a welcome menu screen will appear. Click the "PL-EMS" hyperlink and the InstallShield Wizard dialog box will appear below.
2. Once the Setup program starts running, please click the "**Next**" button for starting installation.



Figure 3-19 PL-EMS Setup Wizard Screen

3. During the installation, it will ask for the place to put the PL\_EMS folder.

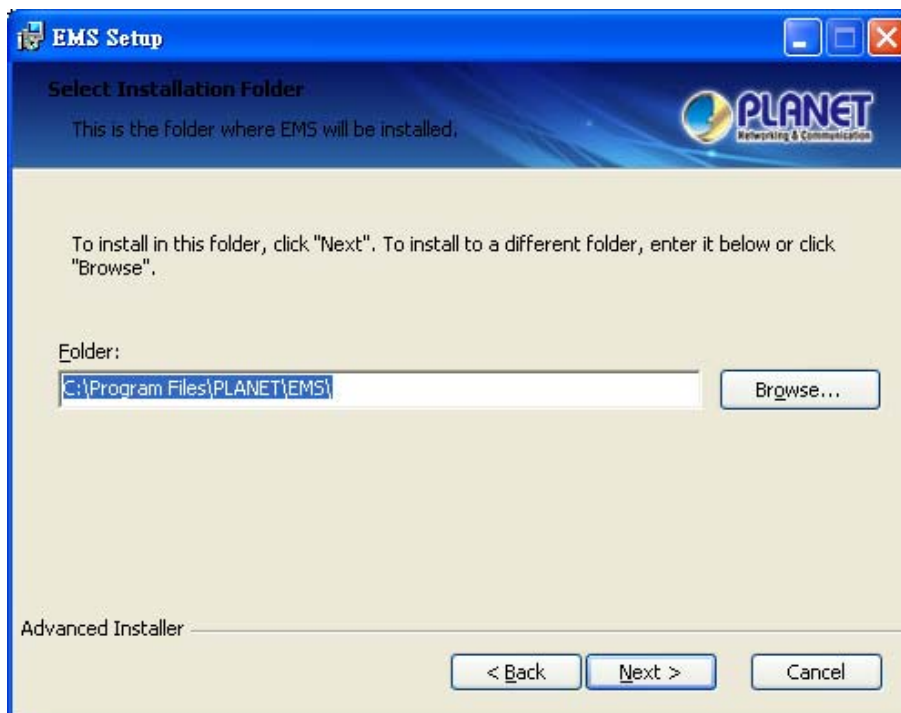

Figure 3-20 PL-EMS Folder Installation Screen

4. Click **"Install"** for starting installation.



Figure 3-21 PL-EMS Installation Screen

5. Click the **"Finish"** button for completing the EMS Setup.

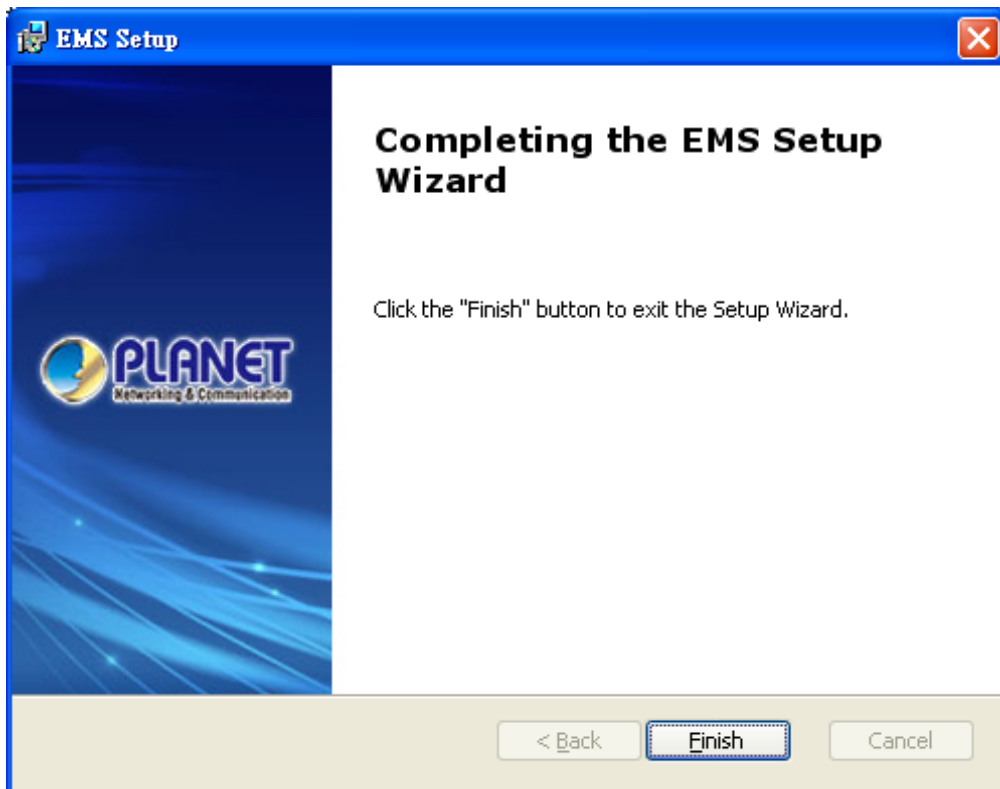

Figure 3-22 PL-EMS Completing Setup Screen

- When the PL-EMS is done, two icons -- **PL Server** and **PL Client** – will appear on the desktop.



### 3.3.3 Starting PLANET EMS Management

The following shows how to start-up the **PL-EMS Management** on the management PC.

- Double-click the **PL Server** icon on the PC desktop. After a couple of seconds, it will appear on the lower-right corner of the system tray.

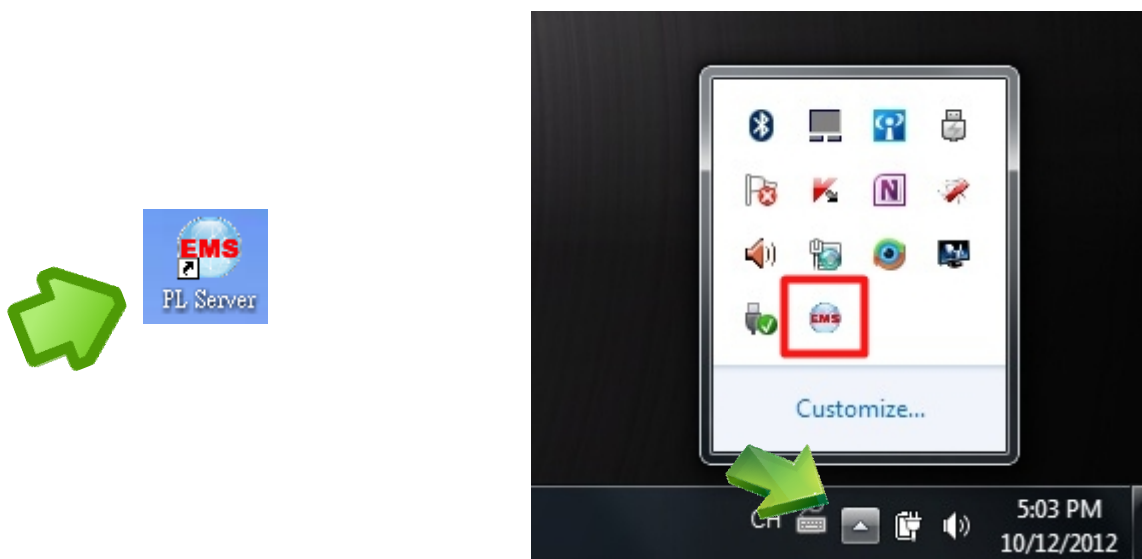

Figure 3-23 PL Server Icon

- Double-click the **PL Client** icon on the PC desktop. It will pop-up a window to enter the user name and password. Please enter the default user name "**admin**" and password "**admin**". The login screen in [Figure 3-24](#) appears.

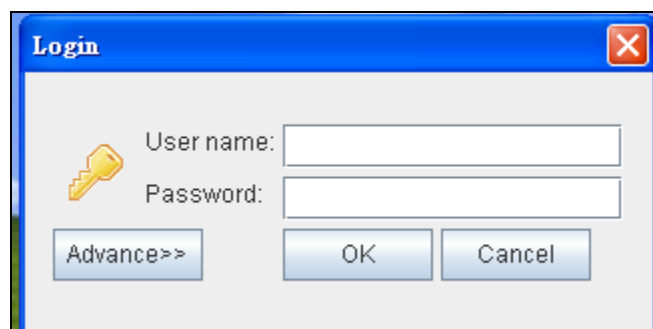
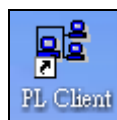

Figure 3-24 PL Client Icon and Login Window

- After entering the user name and password, the PL-EMS main screen will appear as in Figure 3-25.

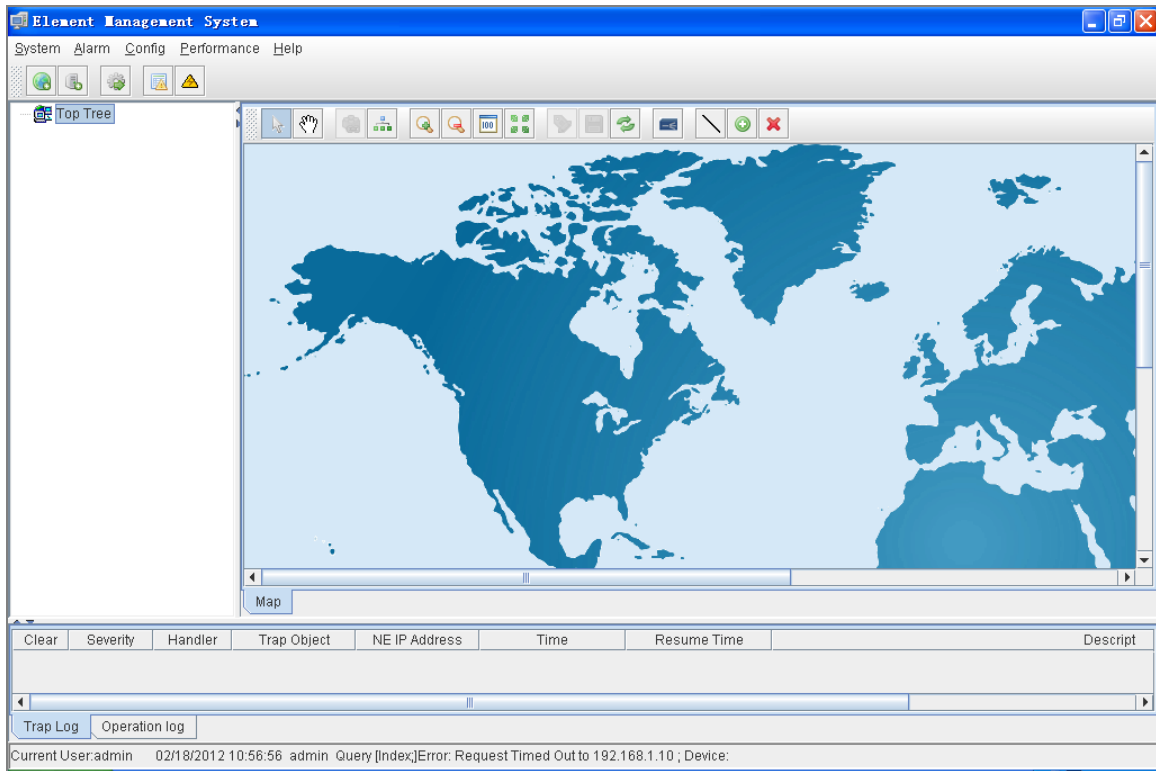

Figure 3-25 Main Screen of EPL-2000 GEPON OLT

### 3.4 SNMP-based Network Management

You can use an external SNMP-based application to configure and manage the GEPON OLT, such as SNMPc Network Manager, HP Openview Network Node Management (NNM) or What's Up Gold. This management method requires the SNMP agent on the switch and the SNMP Network Management Station to use the **same community string**. This management method, in fact, uses two community strings: the **get community string** and the **set community string**. If the SNMP Network Management Station only knows the set community string, it can read and write to the MIBs. However, if it only knows the get community string, it can only read MIBs. The default gets and sets community strings for the GEPON OLT are public.

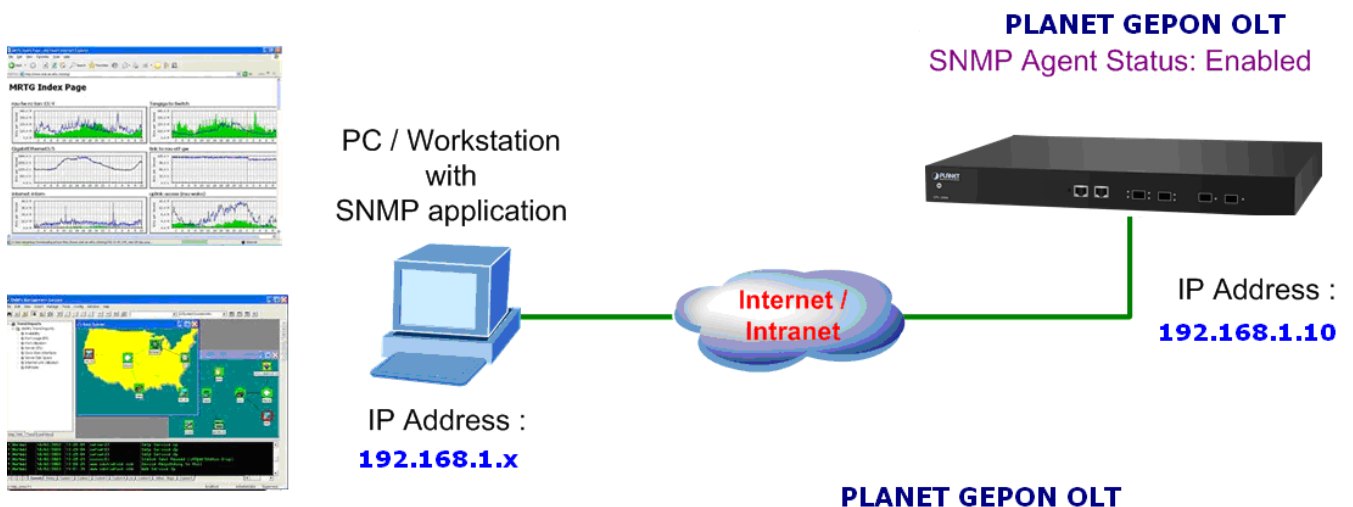

Figure 3-26 SNMP Management Diagram



## 4. EMS Management System

PLANET GEAPON solutions include the OLT EPL-2000 and ONUs -- EPN-102 and EPN-103. The following information introduces the software configuration.

This document explains how to use the EMS Utility for the purpose of evaluating the functionality and usability of Host Interface Protocol. This manual assumes that the reader has a technical background and a base level of understanding regarding the basic operation of PON equipment. The EMS Utility is a demonstration package, intended for evaluation purposes only.

### Organization of the EMS Utility

The screen real estate used by the EMS Utility is divided into three sash windows and one EMS toolbar.

- The upper left panel displays the entities that may be managed by the Host Interface, including the OLT, ONUs and Logical Links. This sash window will be referred to as the **Element Status Window**.
- Left clicking on an entity with the mouse will open a tabbed panel in the upper right sash window that may be used to manage the entity. This sash window will be referred to as the **Entity Management Window**.
- The bottom sash window is used for the purpose of logging the host interface message that is sent and received by the EMS Utility, and will be referred to as the **Message Log**.

If the OLT is running normally and the ONUs register each of their LLIDs, you should see something similar to the figure. The left handed pane shows the MAC addresses of the OLT and the ONU's LLIDs. Depending on the number of ONUs, LLIDs, MAC addresses, etc., you may see something slightly different. If the GUI fails to connect to the OLT, check the IP addresses of the Host PC and the management port. Make sure you can ping the IP address assigned to the management port or uplink port. Also verify that the Host and management IP addresses match in the GUI's Utilities.

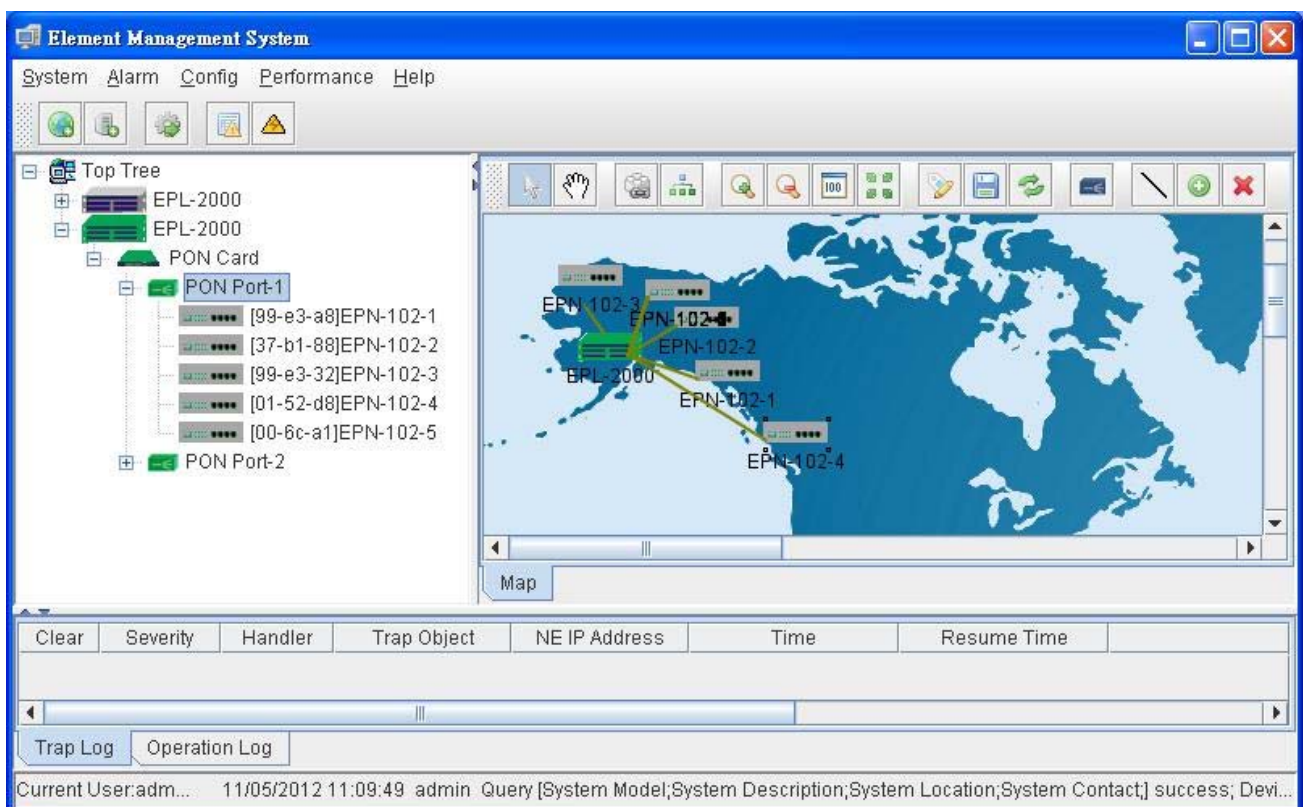



## 4.1 EMS Toolbar

The toolbar includes **System**, **Alarm**, **Config**, **Performance** and **Help** features which allows users to do advanced setting.

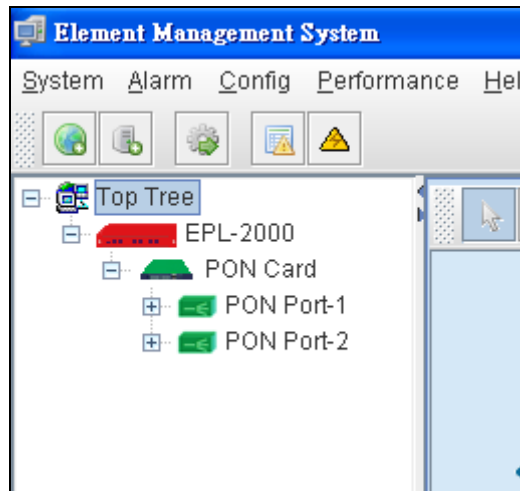

Figure 4-1 EPL-2000 GE PON OLT Toolbar

### 4.1.1 System:

It includes System Config, Mib Browser, Database Maintenance, User Manage and Exit.



Figure 4-2 Toolbar of System Screen

#### 4.1.1.1 System Config

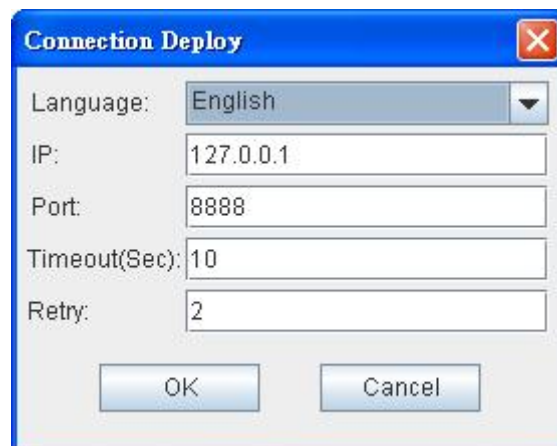

Figure 4-3 System Config Screen

The popup window includes the following fields:

Object	Description
Language:	Allows user to select the language: English and Simplified Chinese.
IP:	Enter the IP address which allows user to remote control from other PC with same IP subnet address. The default IP is 127.0.0.1.
Port:	Enter the UDP port number. The default port is 8888.
Timeout(Sec):	Enter relay time. The default timeout is 10 Sec.
Retry:	Reconnection times. The default retry is 2.

#### 4.1.1.2 MIB Browser

A **management information base (MIB)** is a virtual database used for managing the entities in a communications network.

A built-in trap receiver can receive SNMP traps and handle trap storm.

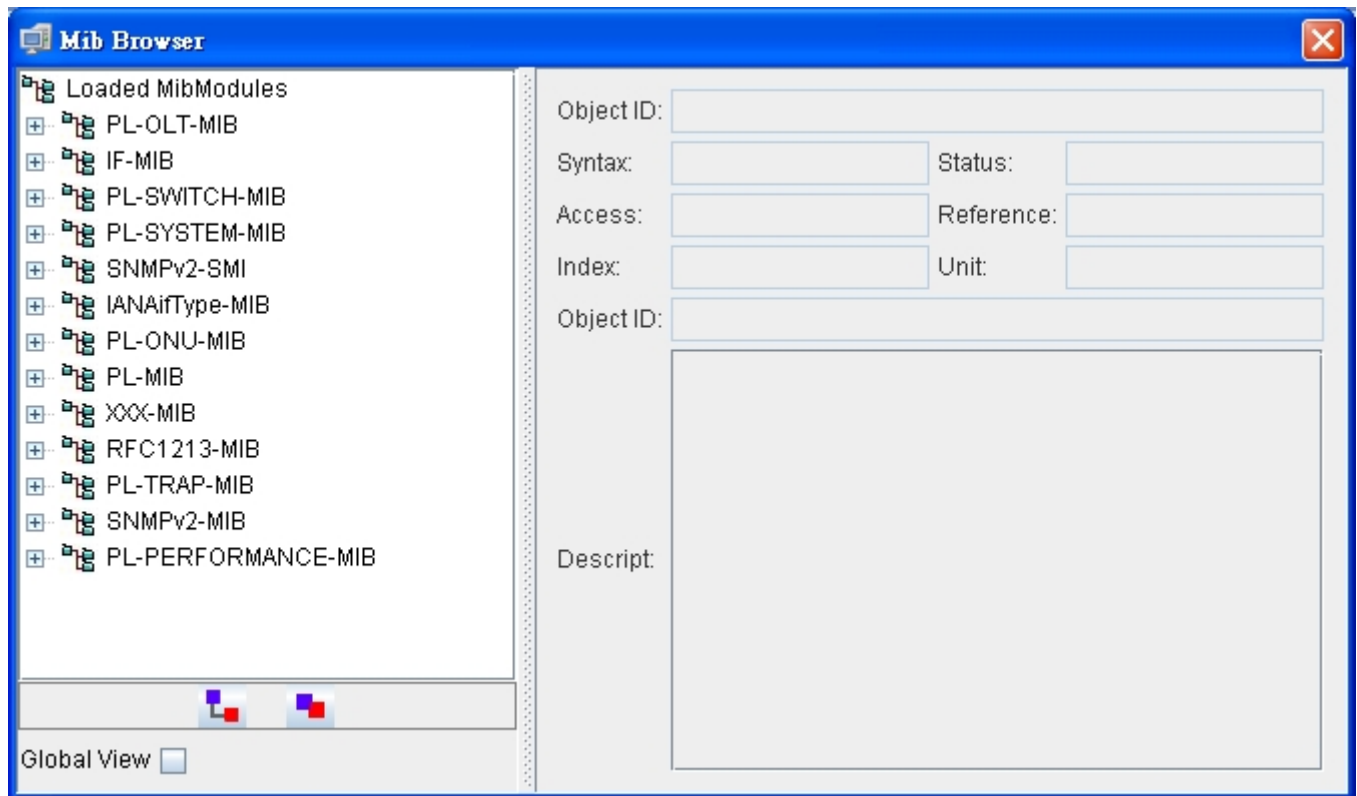

Figure 4-4 MIB Browser Screen

### 4.1.1.3 Database Maintenance

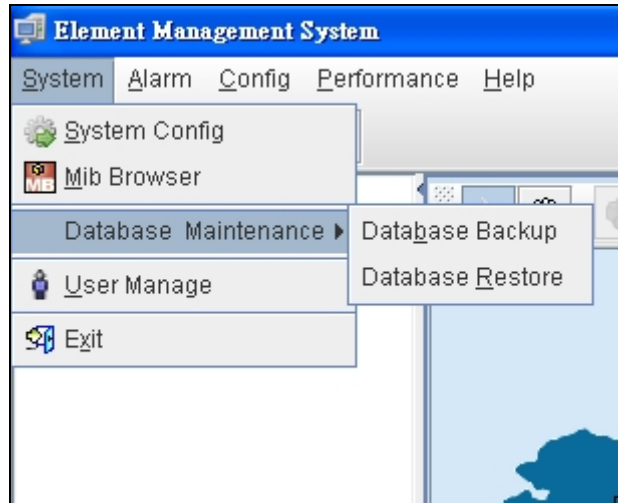

Figure 4-5 Database Maintenance screen

The popup window includes the following fields:

Object	Description
Database Backup:	Save the current data
Database Restore:	Restore the previous backup data

### 4.1.1.4 User Manage

It is allowed to configure the GEAPON OLT to authenticate users logging into the system for management access using local authentication methods. The EPL-2000 provides totally three different security levels for local user management.

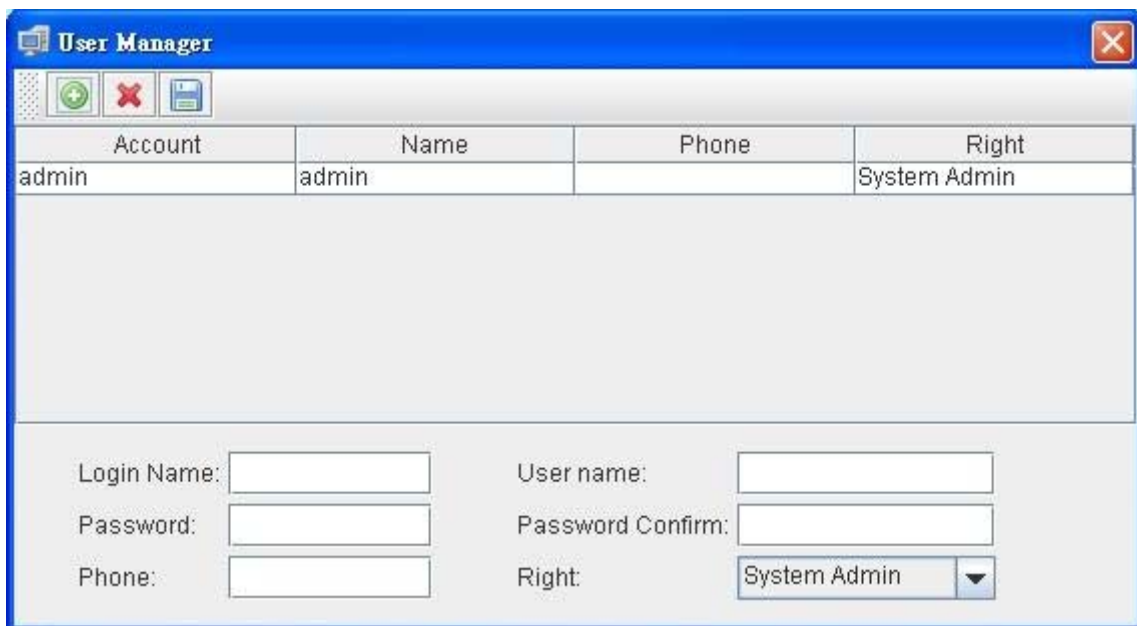





Figure 4-6 User Manager Screen

The popup window includes the following fields:

Object	Description
 :	Add New Account
 :	Delete Account
 :	Save Account
<b>Login Name:</b>	Enter the Name for login
<b>User name:</b>	Enter the Name for user
<b>Password:</b>	Enter the Password
<b>Password Confirm:</b>	Enter the Password for confirming again
<b>Phone:</b>	Enter the Phone No.(Optional)
<b>Right:</b>	Allows user to choose right <ul style="list-style-type: none"> <li>- System Admin</li> <li>- Net Manager</li> <li>- Comm User</li> </ul>

#### 4.1.1.5 Exit

Exit the Element Management System

#### 4.1.2 Alarm:

It includes Alarm Query, Config Trap Rule, System Log and Trap Window.

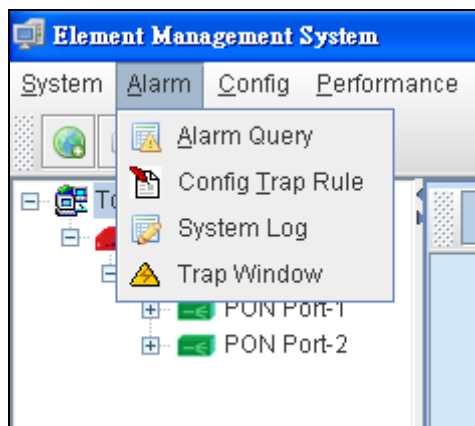

Figure 4-7 Toolbar of Alarm Screen

### 4.1.2.1 Alarm Query

The OLT alarms manager works in concert with the ONUs to provide enhanced management capabilities and complementary set of OLT specific alarms.

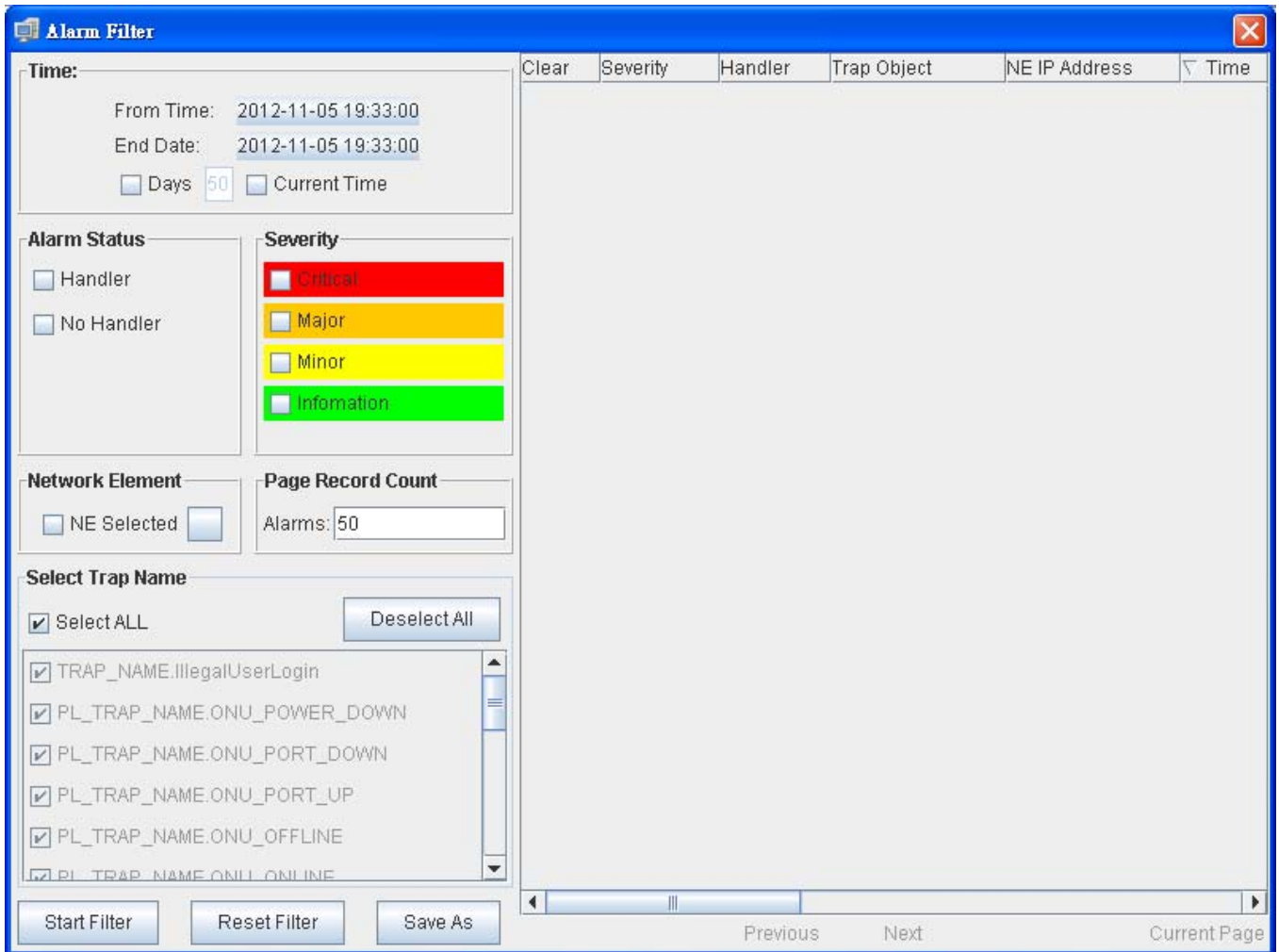

Figure 4-8 Alarm Query screen

The popup window includes the following fields:

Object	Description
<b>Time:</b>	Select the Range of time for filtering.
<b>Alarm Status:</b>	Allows user to choose Handler or No Handler.
<b>Severity:</b>	Allows user to choose the Level of Alarm.
<b>Network Element:</b>	Allows user to choose the Element of devices.
<b>Page Record Counts:</b>	Allows user to edit the number of events for per page.
<b>Select Trap Name:</b>	Allows user to choose the Traps

## 4.1.2.2 Config Trap Rule

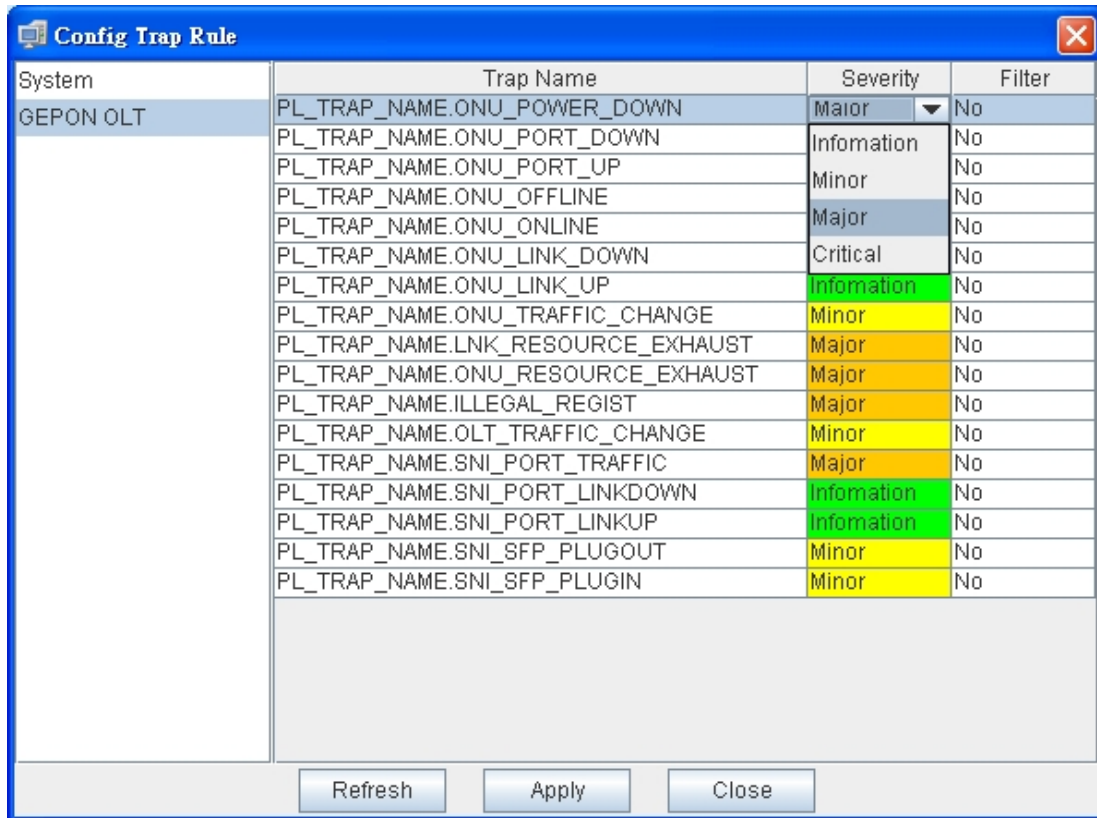

Figure 4-9 Config Trap Rule screen

The popup window includes the following fields:

Object	Description
<b>Refresh:</b>	Refresh the Configuration.
<b>Apply:</b>	Apply the configuration.
<b>Close:</b>	Close the Alarm Filter.

### 4.1.2.3 System Log

The GEAPON EMS system log information is provided here. This window allows you to log the messages happened in this system for later reference.



Figure 4-10 System Log screen

The popup window includes the following fields:

Object	Description
<b>From Time:</b>	Choose the time you want to start.
<b>End Time:</b>	Choose the time you want to end.
<b>User name:</b>	Choose the user.
<b>Page Record:</b>	Allows user to edit the number of logs for each page.
<b>Search:</b>	Start searching the logs.
<b>Save:</b>	Save the Logs.

### 4.1.2.4 Trap Window

This function displays the EPL-2000 trap; it includes **Severity, Handler, Trap Object and more.**



Figure 4-11 Trap Window Screen

### 4.1.3 Config

This feature allows user to configure the Top Tree, EPL-2000, PON Card and ONU property.

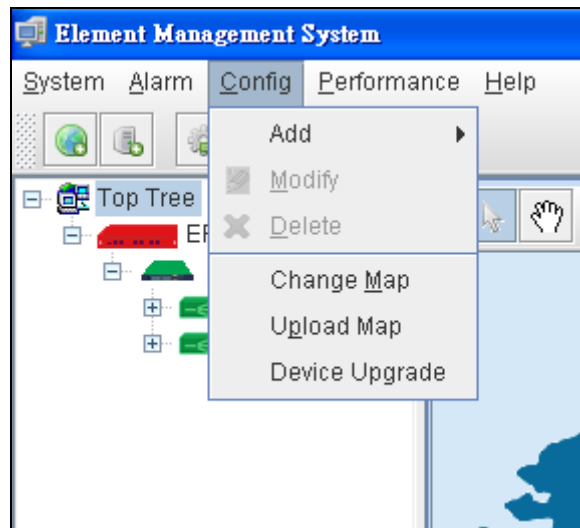

Figure 4-12 Toolbar of Config Screen

The popup window includes the following fields:

Object	Description
<b>Add:</b>	Allows user to add Location and Device
<b>Modify:</b>	Allows user to modify the property of Devices like: EPL-2000 and PON Card.
<b>Delete:</b>	Allows user the delete the Devices.
<b>Change Map:</b>	Allows user to change the background Map.
<b>Upload:</b>	Allows user to upload new Map.
<b>Device Upgrade:</b>	Allows user to upgrade firmware for EPL-2000 or ONU For more details, please refer to Chapter 4.5 "How to upgrade EPL-2000"



### 4.1.4 Performance

This performance function helps user to verify the OLT connection. This window allows user to issue ICMP PING packets to troubleshoot IP connectivity issues.

Once you select the target OLT in the Top Tree and click Performance\Ping from the Toolbar, ICMP packets are transmitted. The report windows pop up automatically until responses to all packets are received, or until a timeout occurs. The Ping screen in [Figure 4-13](#) appears.

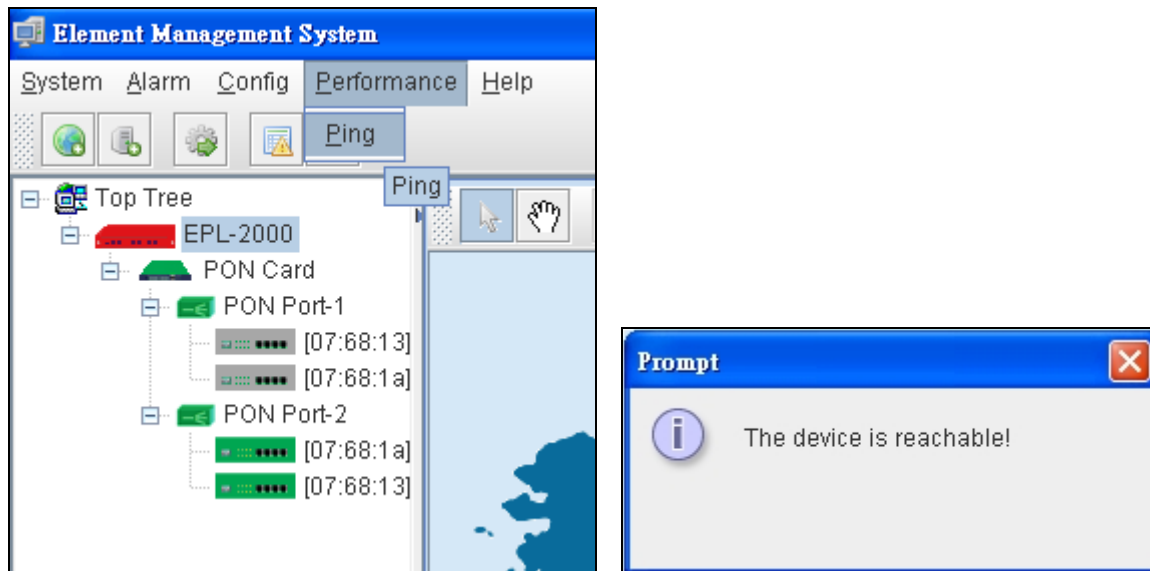

Figure 4-13 Toolbar of Performance screen



Be sure the target OLT's IP address is within the same network subnet of the EMS workstation, or you have to set up the correct gateway IP address.

### 4.1.5 Help

Allows user to change the color of window and language.

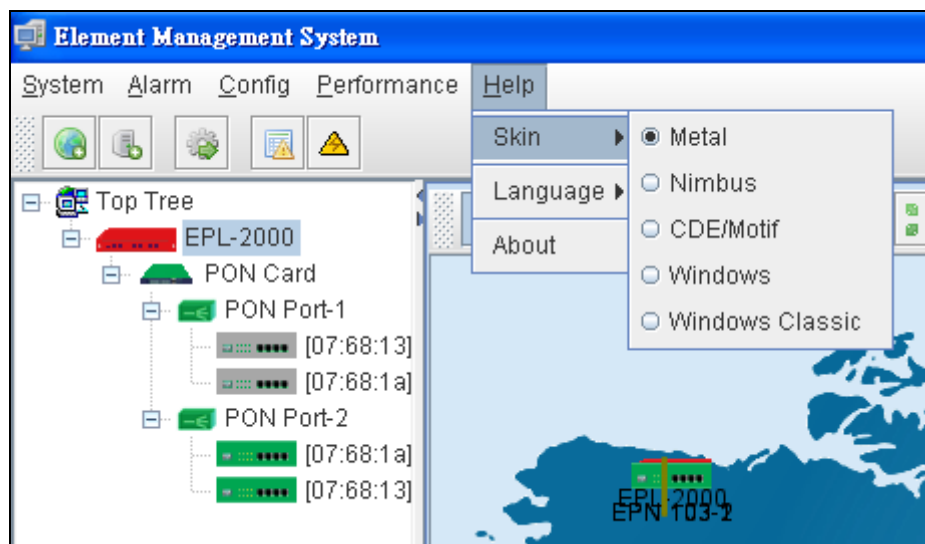

Figure 4-14 Skin Screen

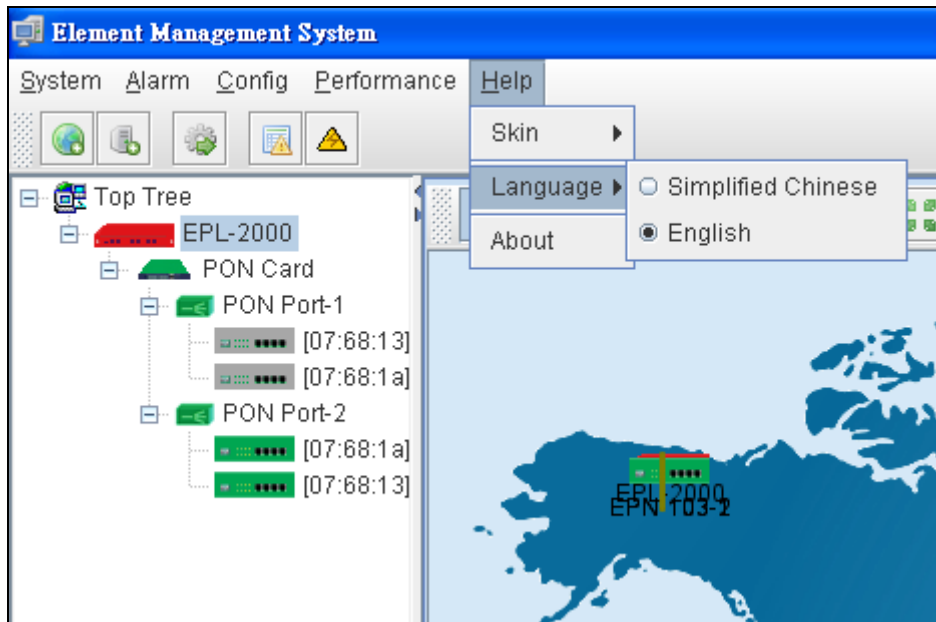

Figure 4-15 Language Screen

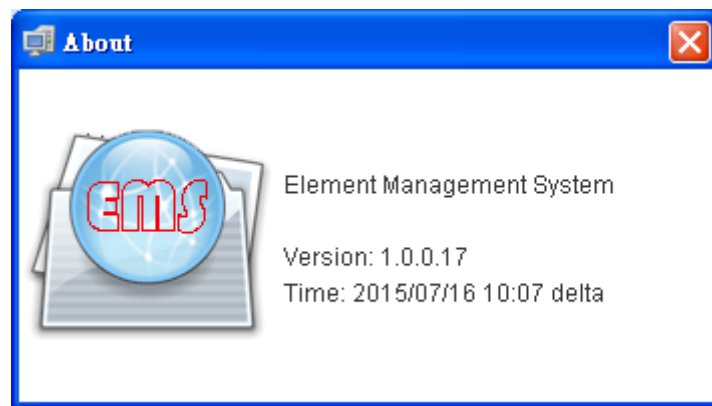

Figure 4-16 About Screen

The popup window includes the following fields:

Object	Description
<b>Skin:</b>	Allows user to change the color of window
<b>Lauange:</b>	Allows user to choose two kinds of languages: English and Simplified Chinese.
<b>About:</b>	Shows the version of EMS utility

## 4.2 OLT Management

To manage EPL-2000, EMS manager needs to add EPL-2000 device. They can add and manage the EPL-2000 from the two types of interfaces:

- **Management Port** – the 10/100BASE-TX RJ45 interface
- **Uplink ports** – the two 1000BASE-X SFP interfaces

The EPL-2000 is shipped with default IP addresses as follows:

**Management Port:** IP Address: **192.168.1.10**  
Subnet Mask: **255.255.255.0**

**Uplink Ports:** IP Address: **192.168.10.100**  
Subnet Mask: **255.255.255.0**

Right-click Top Tree and then click **[Add Device]** in the interface as the windows appear below.

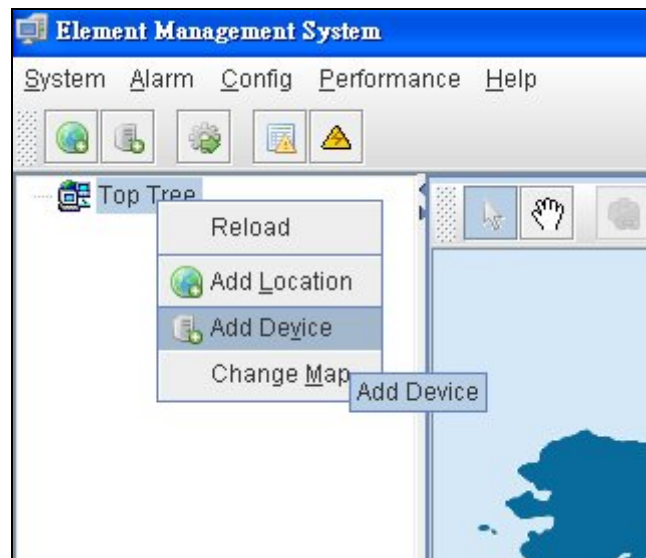

Figure 4-17 Top Tree Interface Screen

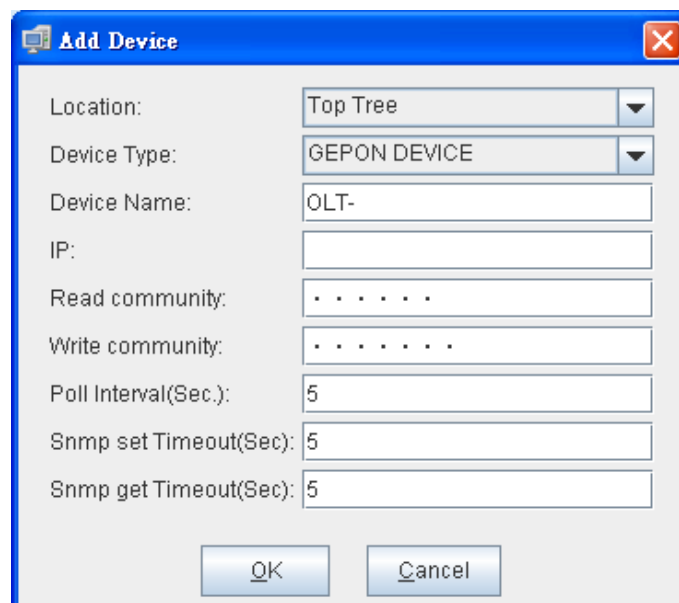
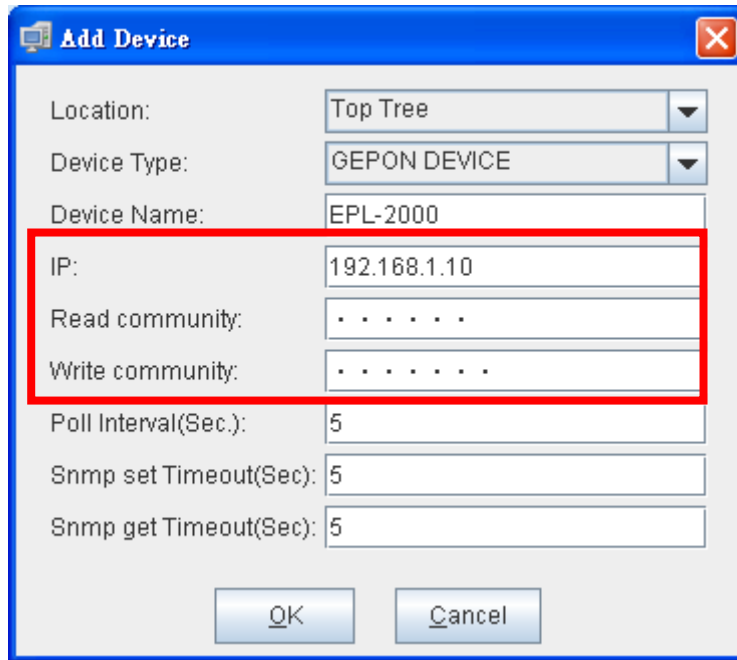

Figure 4-18 Add Device Screen

■ For example, add EPL-2000 through Management Port connection

Please enter the EPL-2000 default IP address “192.168.1.10”, Read Community “public” and Write Community “private” of the management port.



Double-click the EPL-2000 device node unit in the topology tree, and click **Chassis Management** in the interface as the window appears below:

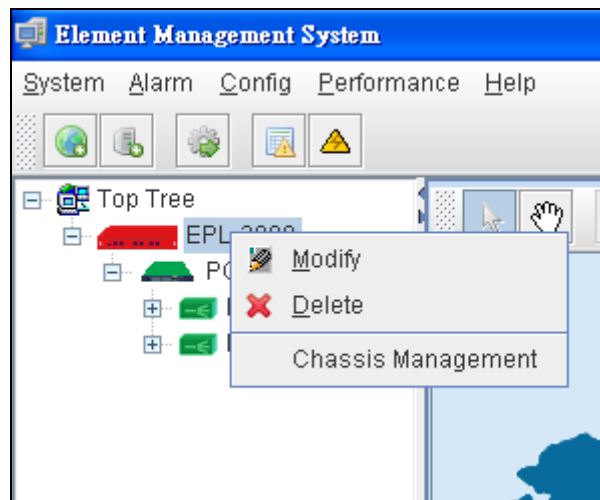

Figure 4-19 EPL-2000 Interface Screen

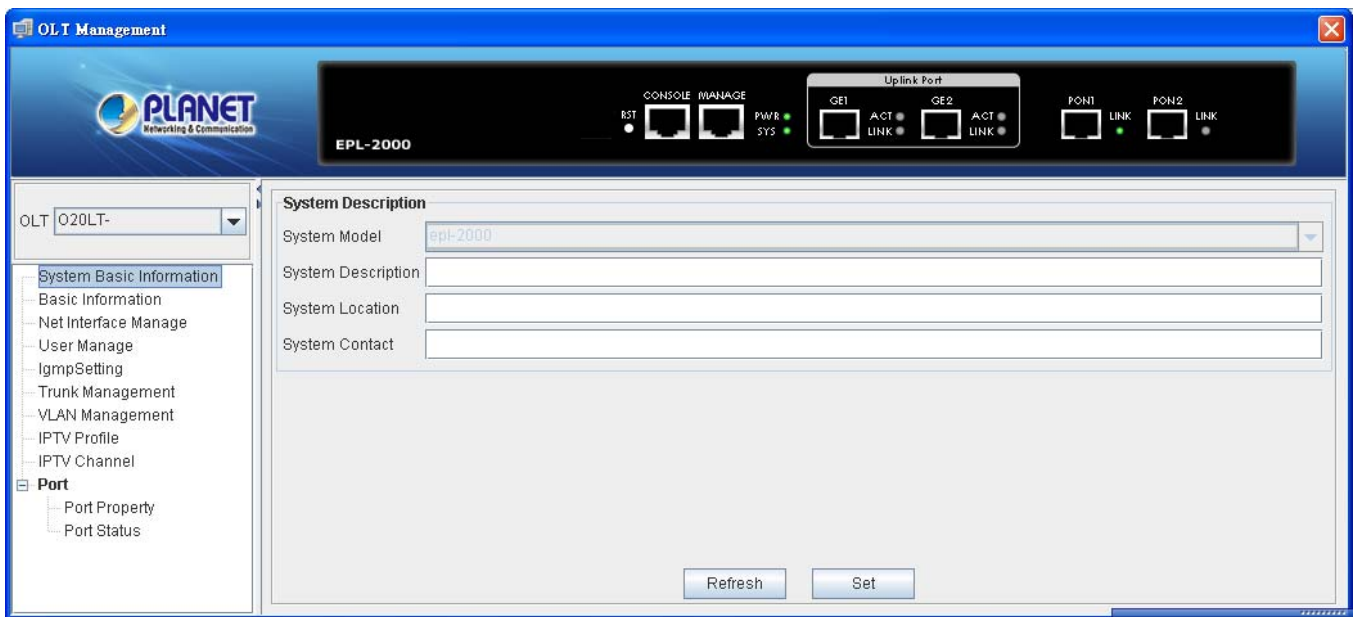

Figure 4-20 EPL-2000 OLT Management Screen

### 4.2.1 System Basic Information

The Basic System Information page provides information for the current device information. Basic System Information page helps an OLT administrator to identify the System Model, System Description, System Location and System Contact.

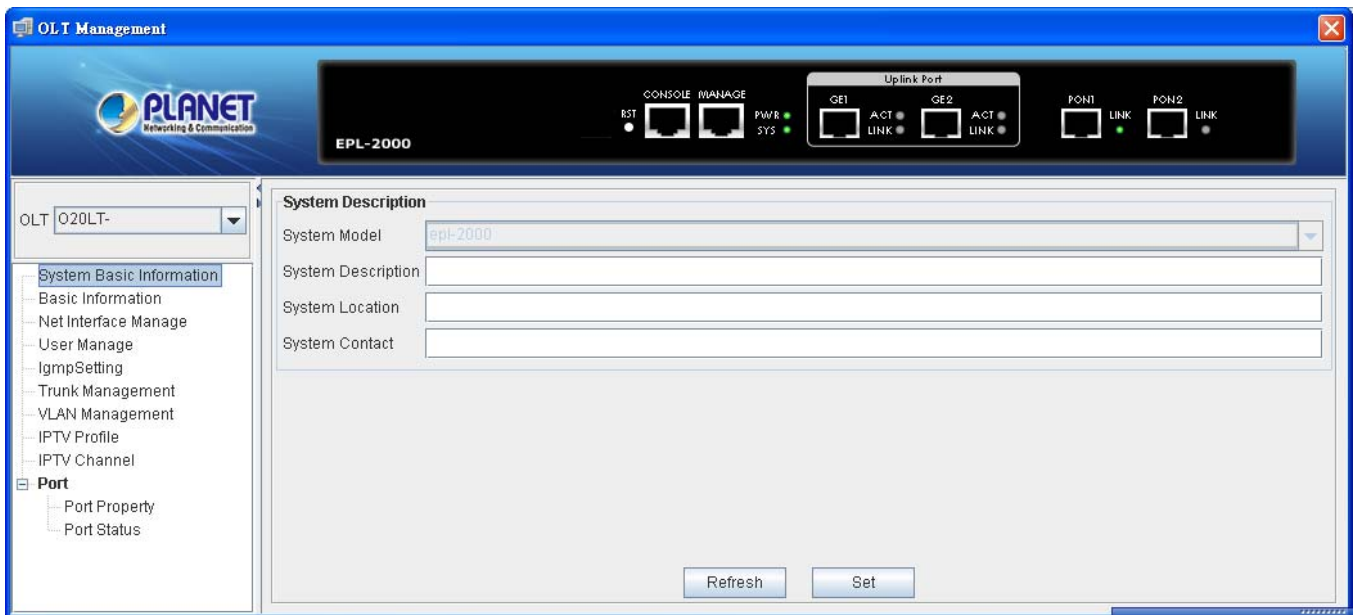

Figure 4-21 System Basic Information Screen

The window includes the following fields:

Object	Description
<b>System Model:</b>	Model name of OLT
<b>System Location:</b>	Allows user to fill in the words for system location
<b>System Description:</b>	Allows user to fill in the words for system description
<b>System Contact:</b>	Allows user to fill in the words for system contact

## 4.2.2 Basic Information

The Basic System Info page provides information for the current device information. Basic System Info page helps an OLT administrator to identify the firmware / hardware version, System Config and Switch Mode Configure.



Figure 4-22 Basic Information Screen

The window includes the following fields:

Object	Description
<b>Card Type:</b>	The OLT device type, EPL-2000 is epon-olt type.
<b>Serial NO.:</b>	The manufacture number.
<b>Hardware Version:</b>	The version of Current Hardware.
<b>Firmware Version:</b>	The version of Current Firmware.
<b>Running Status:</b>	Status of EPL-2000.
<b>Running Time:</b>	The period of time the device has been operational.
<b>Console Port Speed:</b>	The baud rate of Console Port. (Only for Manufacturer)
<b>oam Type:</b>	The default type is ctc-broadcom.
<b>Read Community:</b>	Indicates the community read access string to permit access to SNMP agent.
<b>R/W Community:</b>	Indicates the community write access string to permit access to SNMP agent.
<b>Trap Receiver 1~4 IP Address:</b>	Assign IP address of host to receive trap from the device.
<b>Outbandip:</b>	Manage Port IP address, the default is 192.168.1.10.
<b>OutbandMask:</b>	Manage Port subnet mask, the default is 255.255.255.0

### 4.2.3 Net Interface Management

The system supports two Management IP ports: One is **in-band IP** and one is **out-band IP ports**. This page is allow you to modify the in-band IP

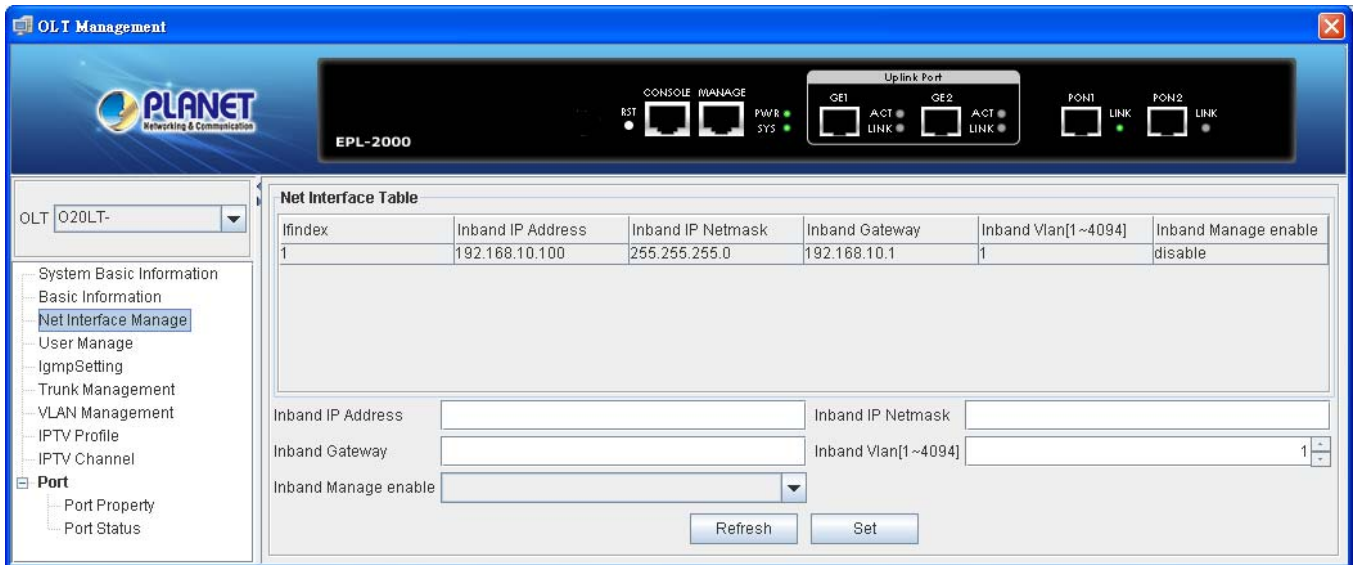

Figure 4-23 Net Interface Management Screen

The window includes the following fields:

Object	Description
<b>Inband IP Address:</b>	Allows user to change the IP Address. The default IP address of Net interface is <b>192.168.10.100</b>
<b>Inband IP Netmask:</b>	Allows user to change the Network Mask. The default Network Mask of Net interface is <b>255.255.255.0</b>
<b>Inband Gateway:</b>	Allows user to change the Default Gateway. The default IP address of Net interface is <b>192.168.10.1</b>
<b>VLAN[1~4094]:</b>	Allows user to change the VLAN ID. Default VLAN ID: <b>1</b>
<b>Inband Manage enable:</b>	Allows user to manage EPL-2000 through GE1 and GE2 ports.

## 4.2.4 User Manage

This page provides an overview of the current users. Currently the only way to login as another user on the web server is to close and reopen the browser. Please press the **“Add”** button for adding new login user account. After the setup is completed, press the **“OK”** button to take effect. Please login web interface with new user name and password as the screen in [Figure 4-24](#) appears.

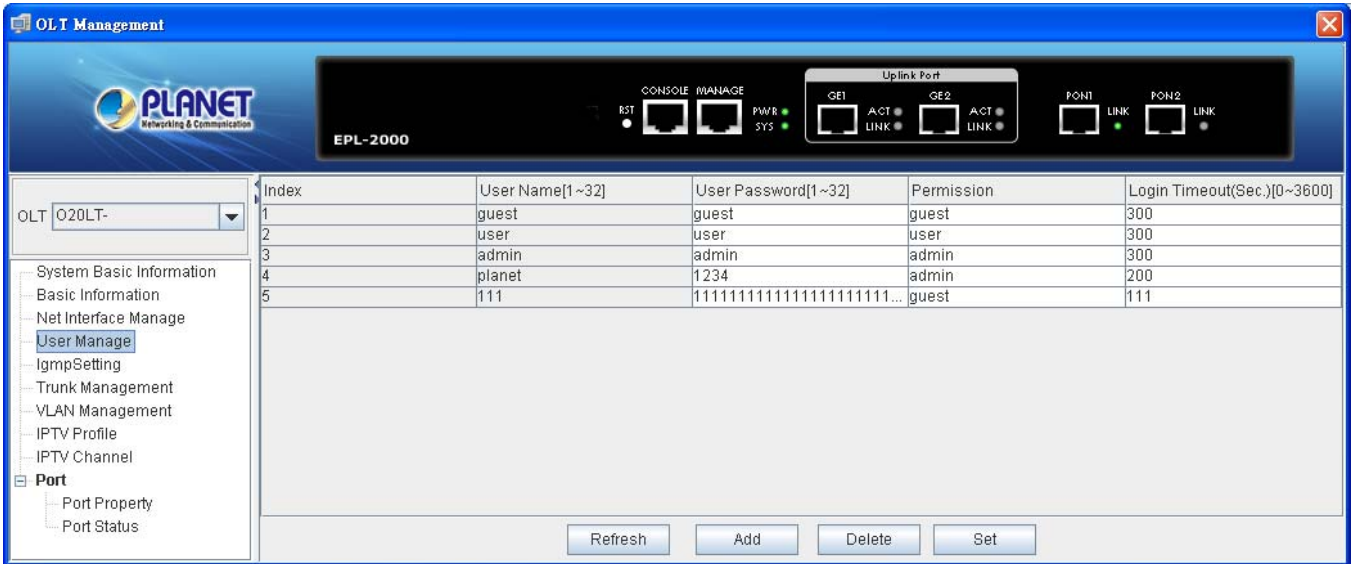

Figure 4-24 User Manage Screen

The window includes the following fields:

Object	Description
<b>Index:</b>	The number identifying the user.
<b>User Name:</b>	The name identifying the user.
<b>User Password:</b>	The password of the user. The allowed string length is <b>1</b> to <b>32</b> .
<b>Permission:</b>	The level of the user. There are three levels: guest, user and admin.
<b>Login Timeout:</b>	The login time for the user -- When idle and the setting time are over, it will log out automatically.

### Buttons

: Click to add a new user.

### Add/Edit User

This page configures a user



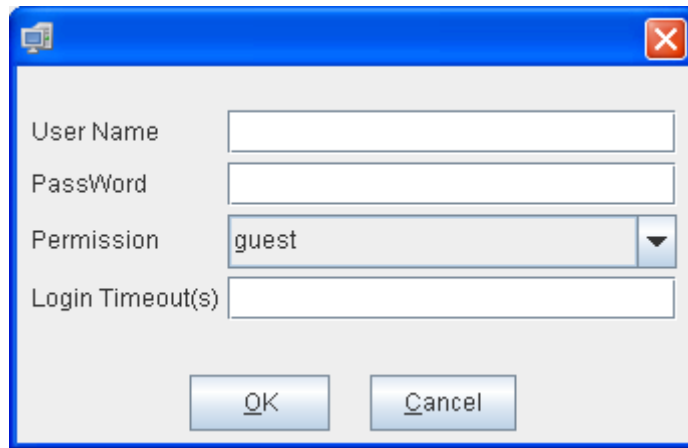

Figure 4-25 User Manage Screen

The window includes the following fields:

Object	Description
<b>User Name:</b>	The name identifying the user.
<b>User Password:</b>	The password of the user. The allowed string length is <b>1</b> to <b>32</b> .
<b>Permission:</b>	The level of the user. There are three levels: guest, user and admin.
<b>Login Timeout:</b>	The login time for the user -- When idle and the setting time are over, it will log out automatically.

### 4.2.5 IGMPSetting

This page allows user to modify the IGMP configuration.

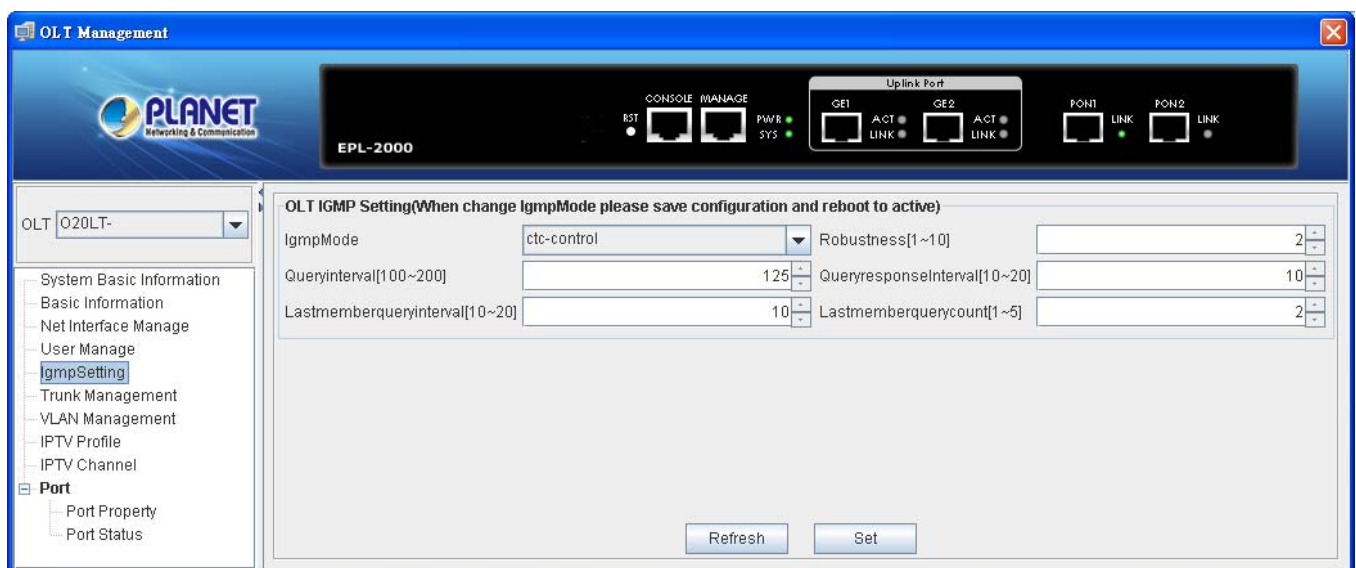

Figure 4-26 IGMP Setting Screen

The window includes the following fields:

Object	Description
<b>IgmpMode:</b>	Allows user to select IGMP mode.
<b>Robustness:</b>	Allows user to modify the Robusness, the range is 1 to 10.
<b>Queryinterval:</b>	Allows user to modify the Query interval, the range is 100 to 200.
<b>QueryresponseInterval:</b>	Allows user to modify the Query respon interval, the range is 10 to 20.
<b>Lastmemberqueryinterval:</b>	Allows user to modify the last member query interval, the range is 10 to 20.
<b>Lastmemberquerycount:</b>	Allows user to modify the last member query count, the range is 1 to 5.

### 4.2.6 Trunk Management

Trunk Management optimizes port usage by linking 2 GE ports together to form a single **Link Aggregated Group (LAG)**. Trunk multiplies the bandwidth between the devices, increases port flexibility, and provides link redundancy.

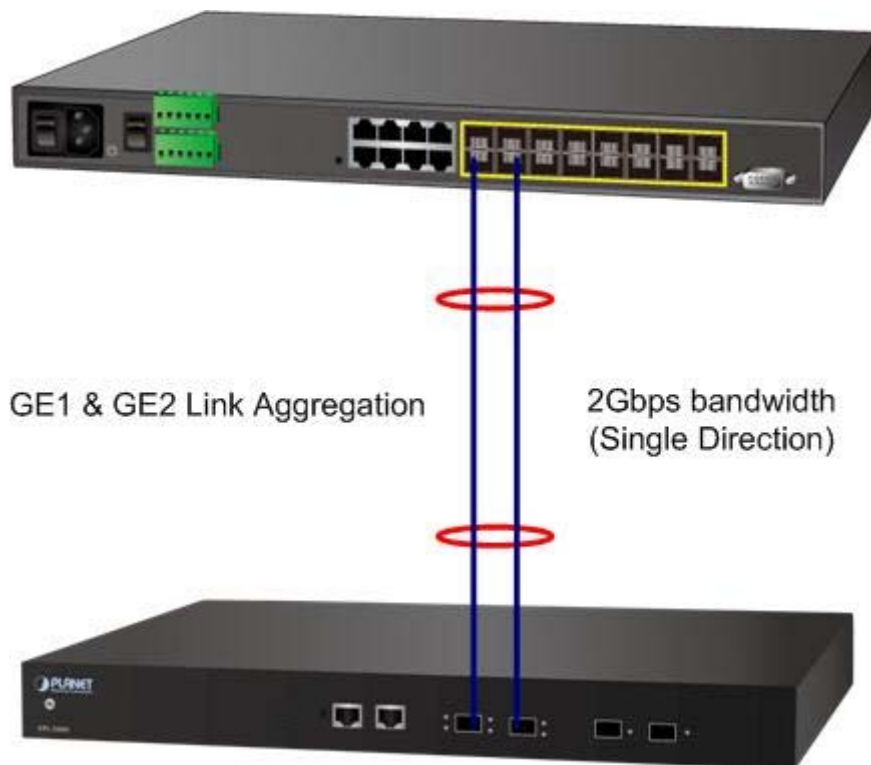

Note

As GEAPON OLT EPL-2000 SFP Ports of GE1 and GE2 are configured in 1000Mbps Forced Mode, the switch's SFP Ports should also change to the same mode if the connection is to be established successfully. Otherwise, the connection might fail.

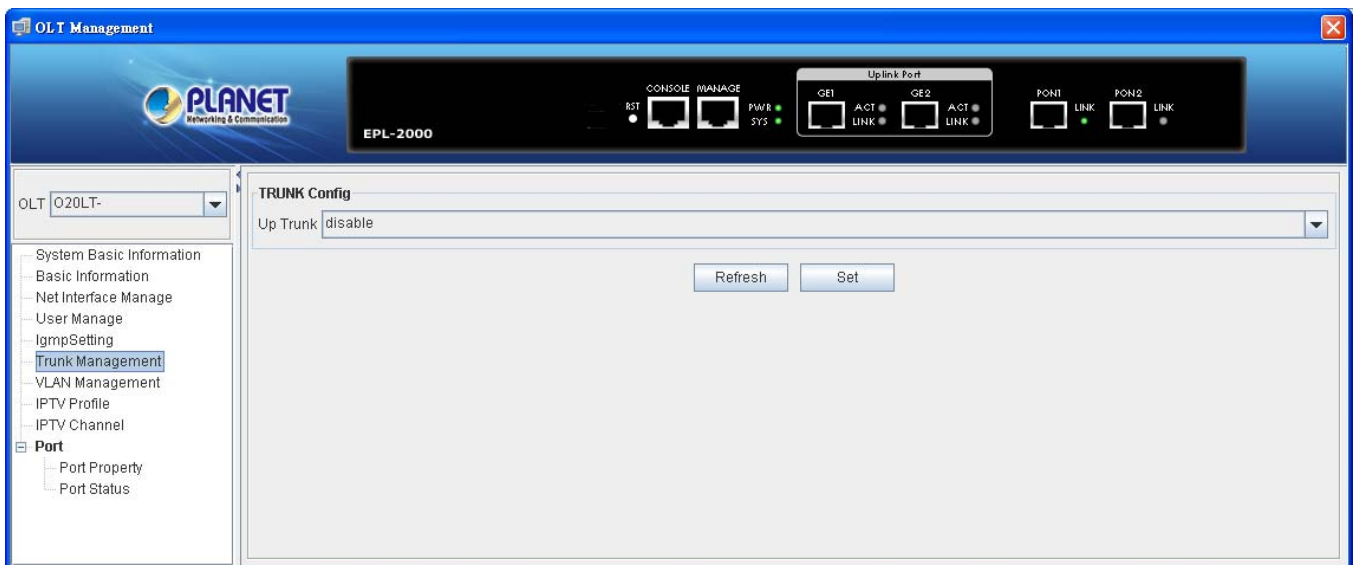

Figure 4-27 Trunk Management Screen

The window includes the following fields:

Object	Description
Up Trunk:	<b>Enable:</b> Trunk function Enable.
	<b>Disable:</b> Trunk function Disable.

## 4.2.7 VLAN Management

### 4.2.7.1 VLAN Overview

A **Virtual Local Area Network (VLAN)** is a network topology configured according to a logical scheme rather than the physical layout. VLAN can be used to combine any collection of LAN segments into an autonomous user group that appears as a single LAN. VLAN also logically segments the network into different broadcast domains so that packets are forwarded only between ports within the VLAN. Typically, a VLAN corresponds to a particular subnet, although not necessarily. VLAN can enhance performance by conserving bandwidth, and improve security by limiting traffic to specific domains.

#### ■ IEEE 802.1Q Standard

**IEEE 802.1Q (tagged) VLAN** are implemented on the Switch. 802.1Q VLAN requires tagging, which enables them to span the entire network (assuming all switches on the network are IEEE 802.1Q-compliant).

VLAN allows a network to be segmented in order to reduce the size of broadcast domains. All packets entering a VLAN will only be forwarded to the stations (over IEEE 802.1Q enabled switches) that are members of that VLAN, and this includes broadcast, multicast and unicast packets from unknown sources.

VLAN can also provide a level of security to your network. IEEE 802.1Q VLAN will only deliver packets between stations that are members of the VLAN. Any port can be configured as either **tagging** or **untagging**:

- The untagging feature of IEEE 802.1Q VLAN allows VLAN to work with legacy switches that don't recognize VLAN tags in packet headers.

- The tagging feature allows VLAN to span multiple 802.1Q-compliant switches through a single physical connection and allows Spanning Tree to be enabled on all ports and work normally.

Some relevant terms:

- **Tagging** - The act of putting 802.1Q VLAN information into the header of a packet.
- **Untagging** - The act of stripping 802.1Q VLAN information out of the packet header.

### 802.1Q VLAN Tags

The figure below shows the 802.1Q VLAN tag. There are four additional octets inserted after the source MAC address. Their presence is indicated by a value of **0x8100** in the Ether Type field. When a packet's Ether Type field is equal to 0x8100, the packet carries the IEEE 802.1Q/802.1p tag. The tag is contained in the following two octets and consists of 3 bits of user priority, 1 bit of Canonical Format Identifier (CFI - used for encapsulating Token Ring packets so they can be carried across Ethernet backbones), and 12 bits of **VLAN ID (VID)**. The 3 bits of user priority are used by 802.1p. The VID is the VLAN identifier and is used by the 802.1Q standard. Because the VID is 12 bits long, 4094 unique VLAN can be identified.

The tag is inserted into the packet header making the entire packet longer by 4 octets. All of the information originally contained in the packet is retained.

#### 802.1Q Tag

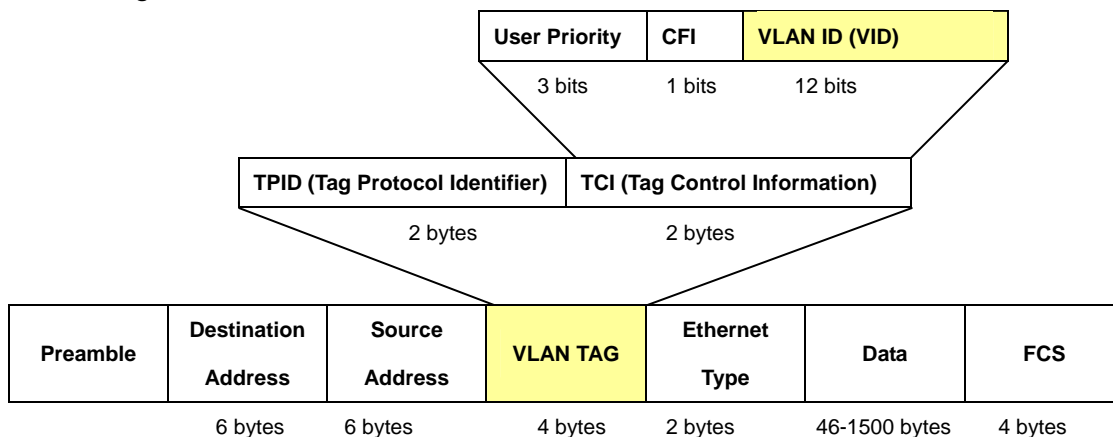

The Ether Type and VLAN ID are inserted after the MAC source address, but before the original Ether Type/Length or Logical Link Control. Because the packet is now a bit longer than it was originally, the Cyclic Redundancy Check (CRC) must be recalculated.

#### Adding an IEEE802.1Q Tag

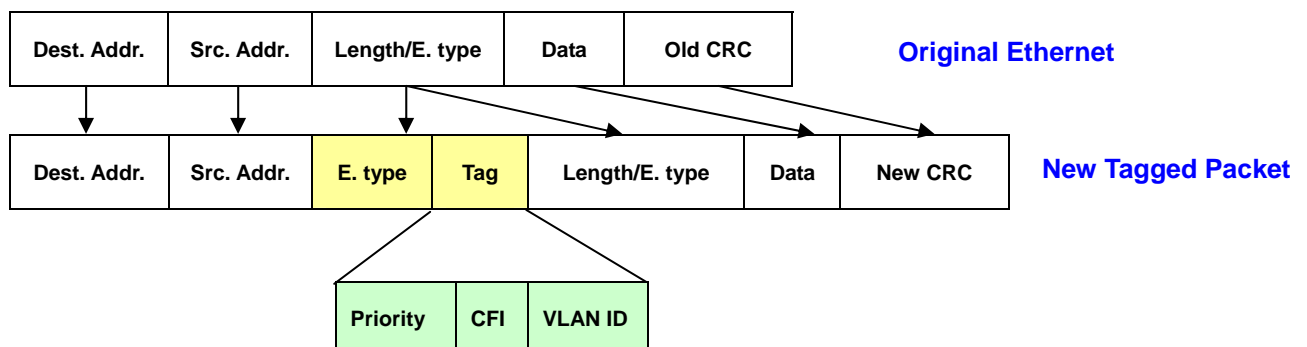

## ■ Port VLAN ID

Packets that are tagged (are carrying the 802.1Q VID information) can be transmitted from one 802.1Q compliant network device to another with the VLAN information intact. This allows 802.1Q VLAN to span network devices (and indeed, the entire network – if all network devices are 802.1Q compliant).

Every physical port on a switch has a PVID. 802.1Q ports are also assigned a PVID, for use within the switch. If no VLAN are defined on the switch, all ports are then assigned to a default VLAN with a PVID equal to 1. Untagged packets are assigned the PVID of the port on which they were received. Forwarding decisions are based upon this PVID, in so far as VLAN are concerned. Tagged packets are forwarded according to the VID contained within the tag. Tagged packets are also assigned a PVID, but the PVID is not used to make packet forwarding decisions, the VID is.

Tag-aware switches must keep a table to relate PVID within the switch to VID on the network. The switch will compare the VID of a packet to be transmitted to the VID of the port that is to transmit the packet. If the two VID are different the switch will drop the packet. Because of the existence of the PVID for untagged packets and the VID for tagged packets, tag-aware and tag-unaware network devices can coexist on the same network.

A switch port can have only one PVID, but can have as many VID as the switch has memory in its VLAN table to store them.

Because some devices on a network may be tag-unaware, a decision must be made at each port on a tag-aware device before packets are transmitted – should the packet to be transmitted have a tag or not? If the transmitting port is connected to a tag-unaware device, the packet should be untagged. If the transmitting port is connected to a tag-aware device, the packet should be tagged.

## ■ Default VLANs

The Switch initially configures one VLAN, VID = 1, called "**default**." The factory default setting assigns all ports on the Switch to the "**default**". As new VLAN are configured in Port-based mode, their respective member ports are removed from the "**default**."

## ■ Assigning Ports to VLANs

Before enabling VLANs for the switch, you must first assign each port to the VLAN group(s) in which it will participate. By default all ports are assigned to VLAN 1 as untagged ports. Add a port as a tagged port if you want it to carry traffic for one or more VLANs, and any intermediate network devices or the host at the other end of the connection supports VLANs. Then assign ports on the other VLAN-aware network devices along the path that will carry this traffic to the same VLAN(s), either manually or dynamically using GVRP. However, if you want a port on this switch to participate in one or more VLANs, but none of the intermediate network devices nor the host at the other end of the connection supports VLANs, then you should add this port to the VLAN as an untagged port.

## ■ Tagged and Untagged

Every port on an 802.1Q compliant network device can be configured as tagged or untagged.

- Tagged:** Ports with tagging enabled will put the VID number, priority and other VLAN information into the header of all packets that flow into those ports. If a packet has previously been tagged, the port will not alter the packet, thus keeping the VLAN information intact. The VLAN information in the tag can then be used by other 802.1Q compliant devices on the network to make packet-forwarding decisions.
- Untagged:** Ports with untagging enabled will strip the 802.1Q tag from all packets that flow into those ports. If the packet doesn't have an 802.1Q VLAN tag, the port will not alter the packet. Thus, all packets received by and forwarded by an untagging port will have no 802.1Q VLAN information. (Remember that the PVID is only used internally within the Switch). Untagging is used to send packets from an 802.1Q-compliant network device to a non-compliant network device.

Frame Income Frame Leave	Income Frame is <b>tagged</b>	Income Frame is <b>untagged</b>
Leave port is tagged	Frame remains tagged	Tag is inserted
Leave port is untagged	Tag is removed	Frame remain untagged

**Table 4-2-1** Ingress/Egress port with VLAN VID Tag/Untag table

#### 4.2.7.2 VLAN Configuration

To completely configure the VLAN functions on the GEOPN OLT, two of the following sub-menus are needed to be well configured.

- **OLT Management/VLAN Management**
- **OLT Management/Port \ Port Property**

#### ■ **OLT Management/VLAN Management**

This page is used for configuring the OLT port VLAN. The VLAN Management page contains fields for managing ports that are part of a VLAN.



Figure 4-28 VLAN Management Screen

The window includes the following fields:

Object	Description
<b>VLAN ID:</b>	Indicates the ID of this particular VLAN.
<b>Description:</b>	Allows user to fill in the words for VLAN description
<b>Egress Ports:</b>	Select specific port for VLAN group.
<b>Untagged Port:</b>	Selects specific port for this check box to transmit outgoing frames without VLAN-Tagged.
<b>Add:</b>	Add new VLAN ID configuration.
<b>Delete:</b>	Delete VLAN ID.
<b>Set:</b>	Set VLAN configuration.

■ OLT Management/Port/Port Property

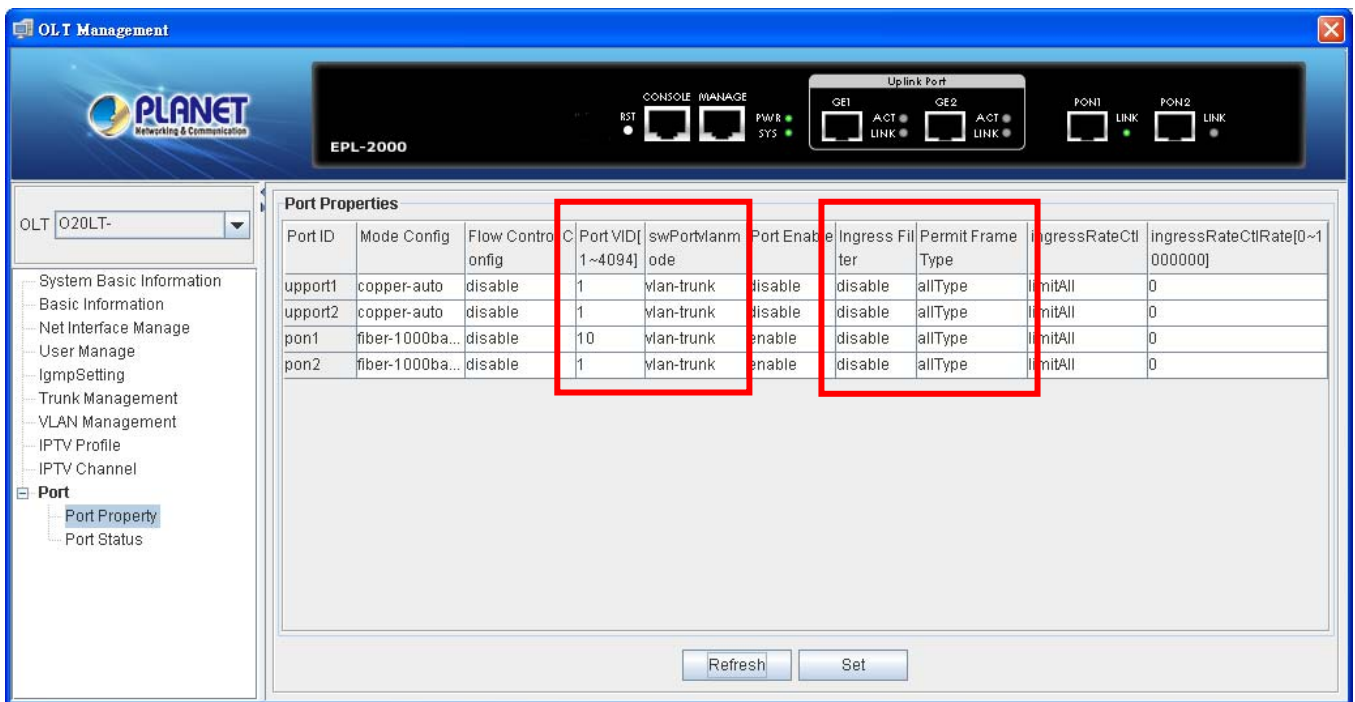

Figure 4-29 Port Property Screen

The window includes the following fields:

Object	Description
<b>Port ID:</b>	This is the logical port name for this row.
<b>Port VID:</b>	Allows to assign PVID for selected port. The range for the PVID is 1-4094. The PVID will be inserted into all untagged frames entering the ingress port. The PVID must be the same as the VLAN ID whose port belongs to VLAN group, or the untagged traffic will be dropped.
<b>swPortvlanmode:</b>	Allows user to modify the VLAN mode, there are two modes: <b>Vlan-access:</b> Only allow Untagged frames <b>Vlan-Trunk:</b> Allows Tagged and Untagged frames.
<b>Ingress Filter:</b>	Enable ingress filtering for a port by checking the box. This parameter affects VLAN ingress processing. If ingress filtering is enabled and the ingress port is not a member of the classified VLAN of the frame, the frame is discarded. <ul style="list-style-type: none"> <li>■ Enabled</li> <li>■ Disabled</li> </ul> By default, ingress filtering is disabled (no checkmark).
<b>Permit Frame Type:</b>	Determines whether the port accepts all frames or only VLAN tagged frames. This parameter affects VLAN ingress processing. If the port only accepts tagged frames, untagged frames received on the port are discarded. Options: <ul style="list-style-type: none"> <li>■ allType</li> </ul>



	<ul style="list-style-type: none"> <li>■ <b>tagged</b></li> </ul> <p>By default, the field is set to <b>allType</b>.</p>
--	--

### 4.2.8 IPTV Profile

This page allows user to create IPTV profile.

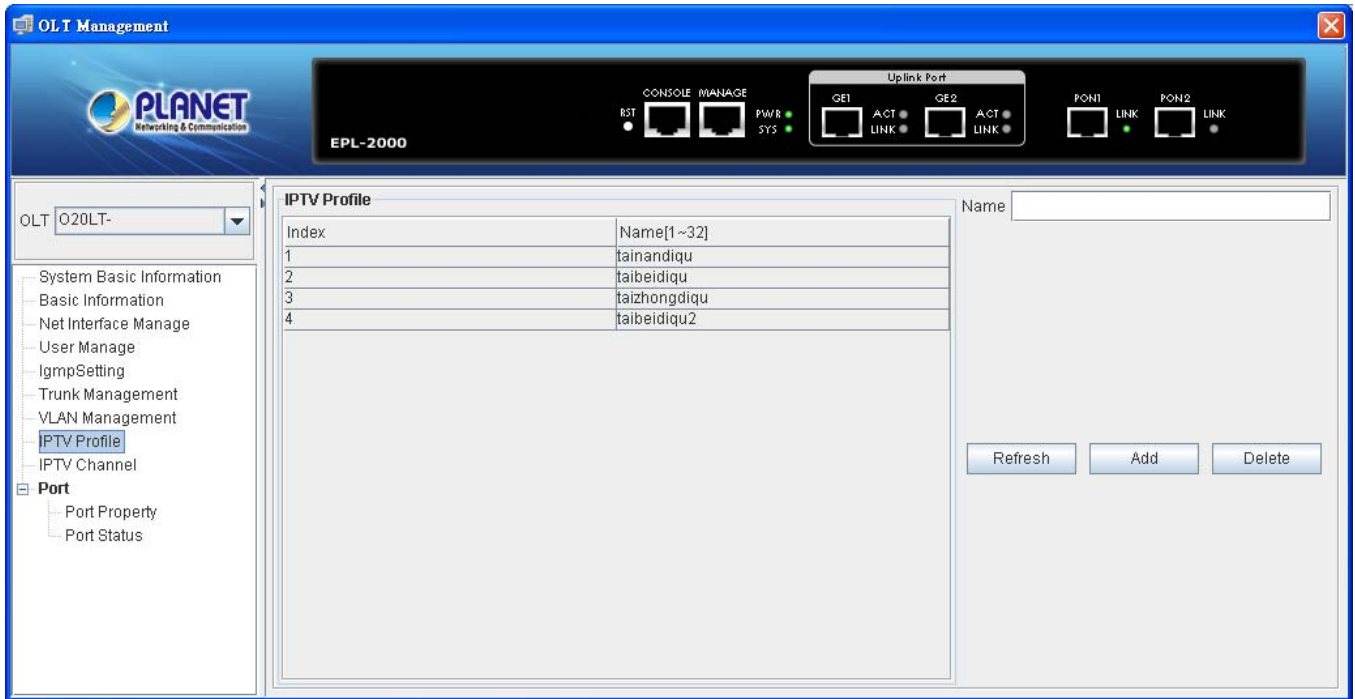

Figure 4-30 IPTV Profile Screen

The window includes the following fields:

Object	Description
<b>Index:</b>	The number identifying the user.
<b>Name:</b>	Indicates the per IPTV profile name.
<b>Refresh:</b>	Refresh the page. Any changes made locally will be undone.
<b>Add:</b>	Add new VLAN ID configuration.
<b>Delete:</b>	Delete VLAN ID.

## 4.2.9 IPTV Channel

This page allows for selecting the specific IPTV profile and creates their own IPTV channels.



Figure 4-31 IPTV Channel Screen

The window includes the following fields:

Object	Description
<b>IPTV Profile:</b>	The user can select specific IPTV Profile; the IPTV profile is creating by IPTV profile page.
<b>Index:</b>	The number identifying the user.
<b>Channel Name:</b>	Indicates the name of IPTV channel.
<b>Multicast Group:</b>	Allows user to fill the multicast streaming IP address.
<b>IPTV Vlan:</b>	Add IPTV VLAN ID configuration.
<b>IPTV User ID:</b>	The User ID is meaning of ONU ethernet ports. For example: EPN-103, there are two ethernet ports. User ID1: Gigabit port (Port 1) User ID2: Fast Ethernet Port (Port 2)
<b>User View Time:</b>	Configures the time for viewing IPTV channel.

## 4.2.10 Port Property

In Port Property you can configure the settings of each port to control the connection parameters, and the status of each port is listed below:

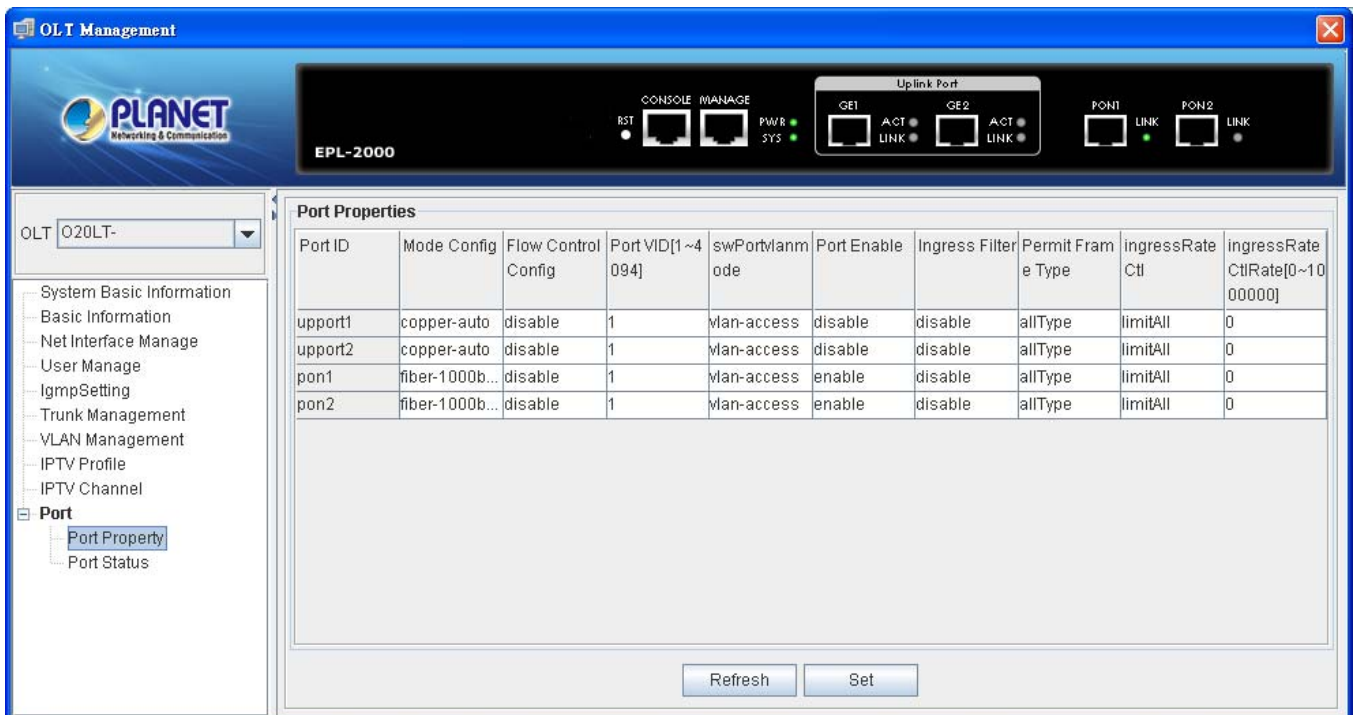

Figure 4-32 Port Property Screen

The popup window includes the following fields:

Object	Description
<b>Port ID:</b>	This is the logical port name for this row.
<b>Mode Config:</b>	Select any available link mode for the given EPL-2000 fiber port. Draw the menu bar to select the mode. <ul style="list-style-type: none"> <li>■ <b>Auto</b> - Setup Auto negotiation for copper interface.</li> <li>■ <b>Copper-1000BASE</b> - Force sets 1000Mbps/Full-Duplex mode.</li> <li>■ <b>Fiber-1000BASE</b> - Force sets 1000Mbps/Full-Duplex mode.</li> </ul>
<b>Flow Control Config:</b>	Whether or not the receiving node sends feedback to the sending node is determined by this item. When enabled, once the device exceeds the input data rate of another device, the receiving device will send a PAUSE frame which halts the transmission of the sender for a specified period of time. When disabled, the receiving device will drop the packet if too much to process.
<b>Port VID:</b>	Allows to assign PVID for selected port. The range for the PVID is 1-4094. The PVID will be inserted into all untagged frames entering the ingress port. The PVID must be the same as the VLAN ID whose port belongs to VLAN group, or the untagged traffic will be dropped.
<b>swPortvlanmode:</b>	Allows user to modify the VLAN mode, there are two modes:

	<p><b>Vlan-access:</b> Only allow Untagged frames</p> <p><b>Vlan-Trunk:</b> Allows Tagged and Untagged frames.</p>
<b>Port Enable:</b>	<p>The port can be set to disable or enable mode.</p> <p>If the port is set as 'Disable', it will not receive or transmit any packet.</p>
<b>Ingress Filter:</b>	<p>Enable ingress filtering for a port by checking the box. This parameter affects VLAN ingress processing. If ingress filtering is enabled and the ingress port is not a member of the classified VLAN of the frame, the frame is discarded.</p> <ul style="list-style-type: none"> <li>■ <b>Enabled</b></li> <li>■ <b>Disabled</b></li> </ul> <p>By default, ingress filtering is disabled (no checkmark).</p>
<b>Permit Frame Type:</b>	<p>Determines whether the port accepts all frames or only VLAN tagged frames. This parameter affects VLAN ingress processing. If the port only accepts tagged frames, untagged frames received on the port are discarded.</p> <p>Options:</p> <ul style="list-style-type: none"> <li>■ <b>allType</b></li> <li>■ <b>tagged</b></li> </ul> <p>By default, the field is set to <b>allType</b>.</p>
<b>Ingress Rate Control:</b>	<p>There are four kinds of Limit Rates:</p> <ol style="list-style-type: none"> <li>1. LimitAll</li> <li>2. LimitB</li> <li>3. LimitM</li> <li>4. LimitBMUC</li> </ol>
<b>Ingress Rate Control Rate [0~1000000]</b>	<p>Set up the Rate of Ingress Rate.</p>



As GEPON OLT EPL-2000 SFP Ports of GE1 and GE2 are configured in **1000Mbps Forced Mode**, the switch's SFP Ports should also be changed to 1000Mbps Forced Mode if the connection is to be established successfully. Otherwise, the connection might fail.

### 4.2.11 Port Status

This page displays the current port configurations and operating status – it is a ports' configurations summary table. Via the summary table, you can know status of each port clearly at a glance, like Port Link Up/Link Down status, Link Speed and Duplex mode.

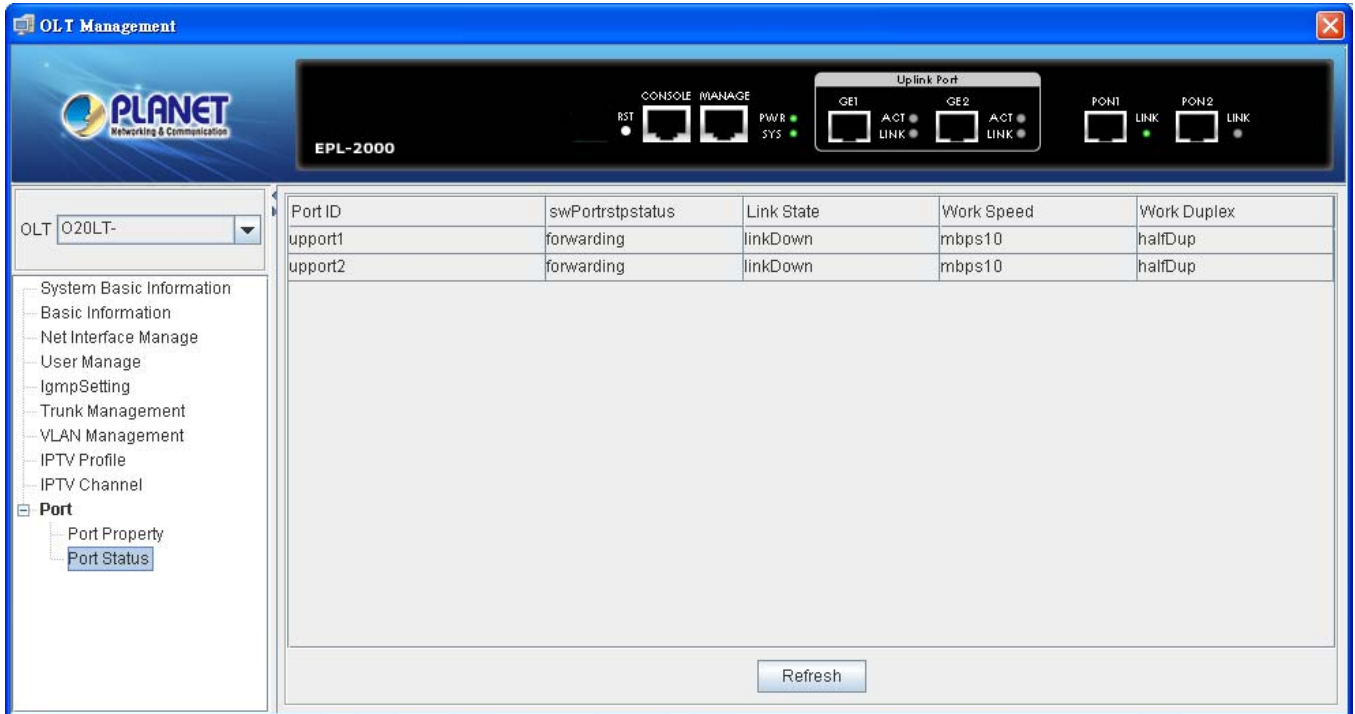

Figure 4-33 Port Status Screen

### 4.3 PON Card Management

Double-click the PON Card device node unit in the topology tree or right-click **PON Card Management** in the interface as the window shows below:

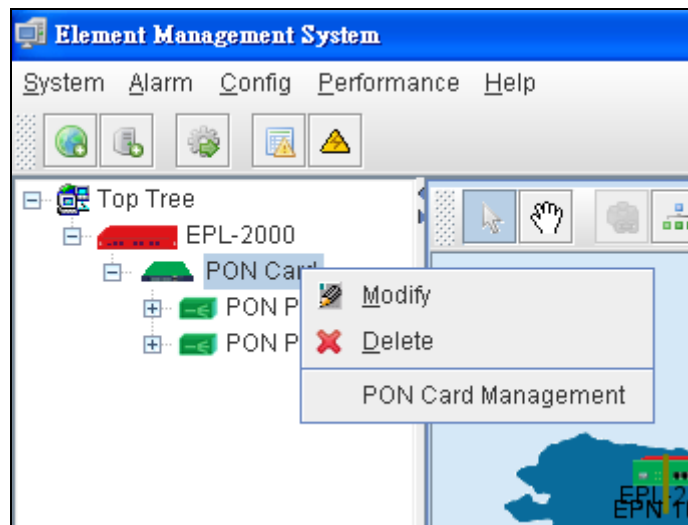

Figure 4-34 PON Card Interface Screen

#### 4.3.1 Interface Information

This page displays the current PON Card Information – it is a PON Card Configuration page. Via the PON Card Configuration page, you can know PON Card MAC addresses or configure ONU AUTH, etc.

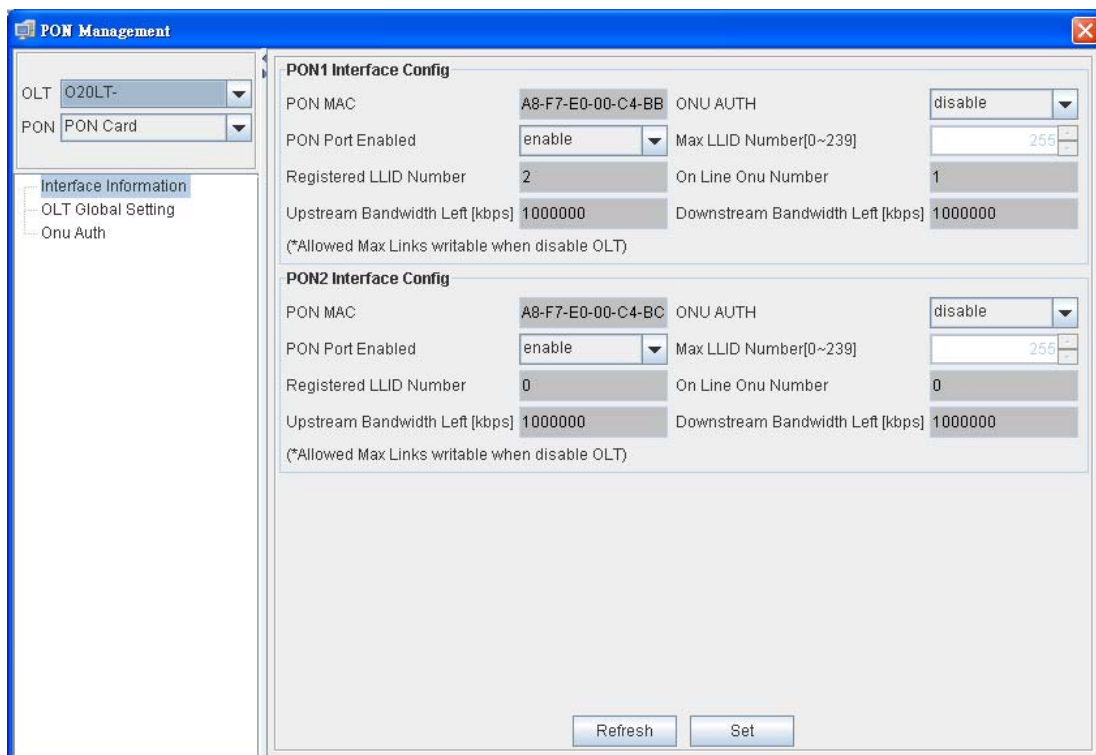
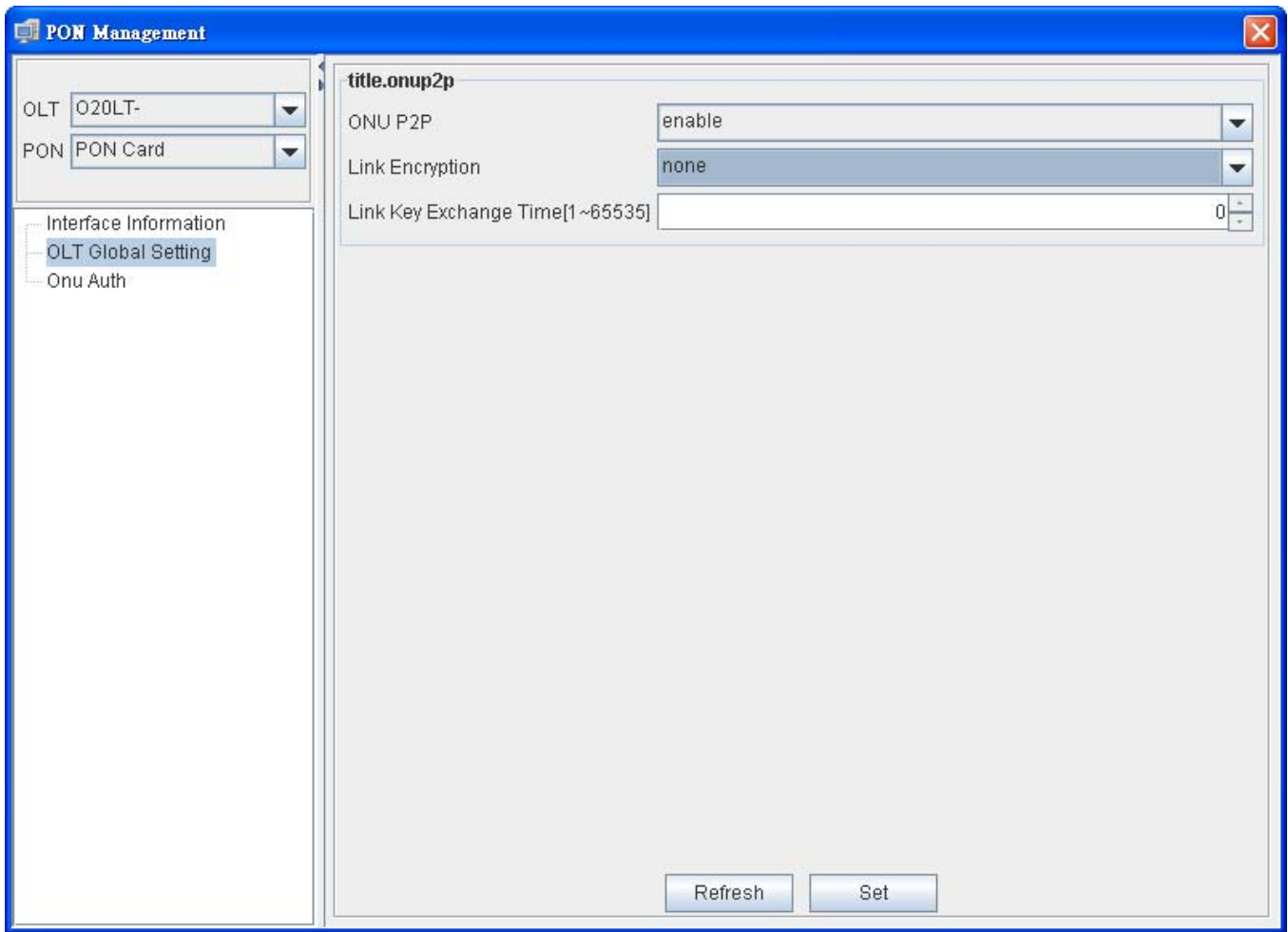

Figure 4-35 Interface Information Screen

The popup window includes the following fields:

Object	Description
<p><b>PON1 Interface Config:</b></p>	<p><b>PON MAC:</b> Shows the PON1 interface MAC address.</p> <p><b>ONU AUTH:</b> Selects the Auth mode.</p> <p><b>PON Port Enabled:</b> Enabled or Disable the PON1 port.</p> <p><b>Max LLID Number[0~239]:</b> Allows for setting value of LLID</p> <p><b>Registered LLID Number:</b> Allows for setting number of Registered LLID.</p> <p><b>On Line ONU Number:</b> Shows how many current ONUs connects on PON1.</p> <p><b>Upstream Bandwidth Left[kbps]:</b> Shows how much current upstream bandwidth left.</p> <p><b>Downstream Bandwidth Left[kbps]:</b> Shows how much current downstream bandwidth left.</p>
<p><b>PON2 Interface Config:</b></p>	<p><b>PON MAC:</b> Shows the PON2 interface MAC address.</p> <p><b>ONU AUTH:</b> Selects the Auth mode.</p> <p><b>PON Port Enabled:</b> Enabled or Disable the PON2 port.</p> <p><b>Max LLID Number[0~239]:</b> Allows for setting value of LLID</p> <p><b>Registered LLID Number:</b> Allows for setting number of Registered LLID.</p> <p><b>On Line ONU Number:</b> Shows how many current ONUs connects on PON1.</p> <p><b>Upstream Bandwidth Left[kbps]:</b> Shows how much current upstream bandwidth left.</p> <p><b>Downstream Bandwidth Left[kbps]:</b> Shows how much current downstream bandwidth left.</p>

### 4.3.2 OLT Global Setting



**Figure 4-36** OLT Global Setting Screen

The popup window includes the following fields:

Object	Description
<b>ONU P2P:</b>	<b>Enabled/Disable</b> the ONU P2P function.
<b>Link Encryption:</b>	Selects the link encryption mode, there are three modes. <b>None</b> , <b>Teknoves</b> and <b>CTC</b> mode
<b>Link Key Exchange Time:</b>	Arranges the time of Link Key, the range is 1 to 65535.



### 4.3.3 ONU Auth

The screenshot shows the 'PON Management' window. On the left, there is a sidebar with a tree view containing 'Interface Information', 'OLT Global Setting', and 'Onu Auth'. The main content area has a 'PON Port' dropdown menu currently set to 'Pon Port 0'. Below this is a section titled 'ONU Auth' containing a table with the following columns: 'Index', 'Mac Address', 'LOID[1~24]', and 'Password[1~24]'. The table is currently empty. At the bottom of the main area, there are three buttons: 'Refresh', 'Add', and 'Delete'.

Figure 4-37 Onu Auth Screen

The popup window includes the following fields:

Object	Description
<b>PON Port:</b>	Allows for selecting which PON port for modifying.
<b>Index:</b>	The number identifying the user.
<b>Mac Address:</b>	The MAC address of the entry.
<b>LOID:</b>	The LOID of the entry, it is same as user name.
<b>Password:</b>	The password of the user. The allowed string length is <b>1</b> to <b>24</b> .



If you want to configure ONU Auth, the user must enable the ONU Auth from Interface Information page.

## 4.4 ONU Management

Double-click the EPL-2000 device node unit in the topology tree or right-click **Chassis Management** in the interface as the windows show below:

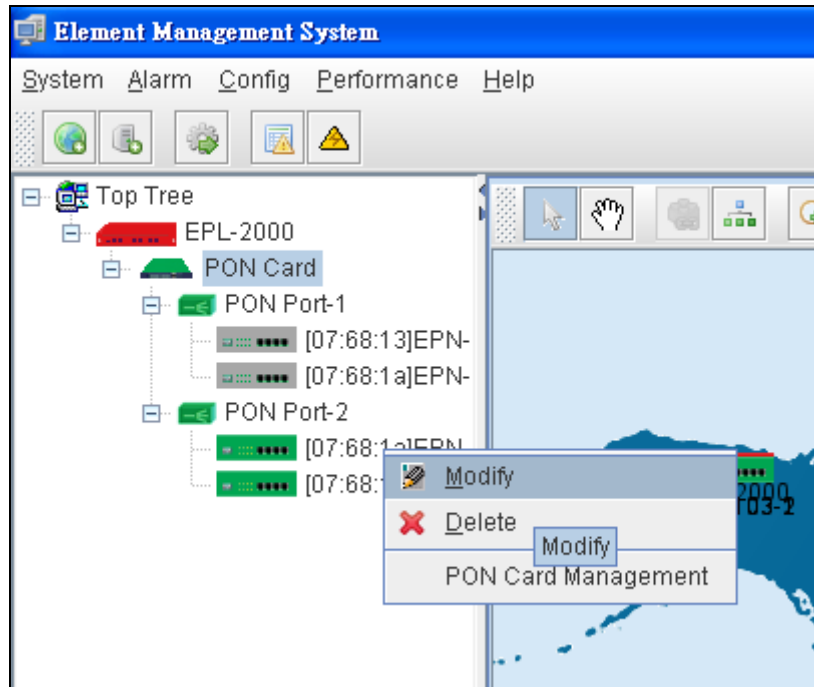

Figure 4-38 ONU Interface Screen

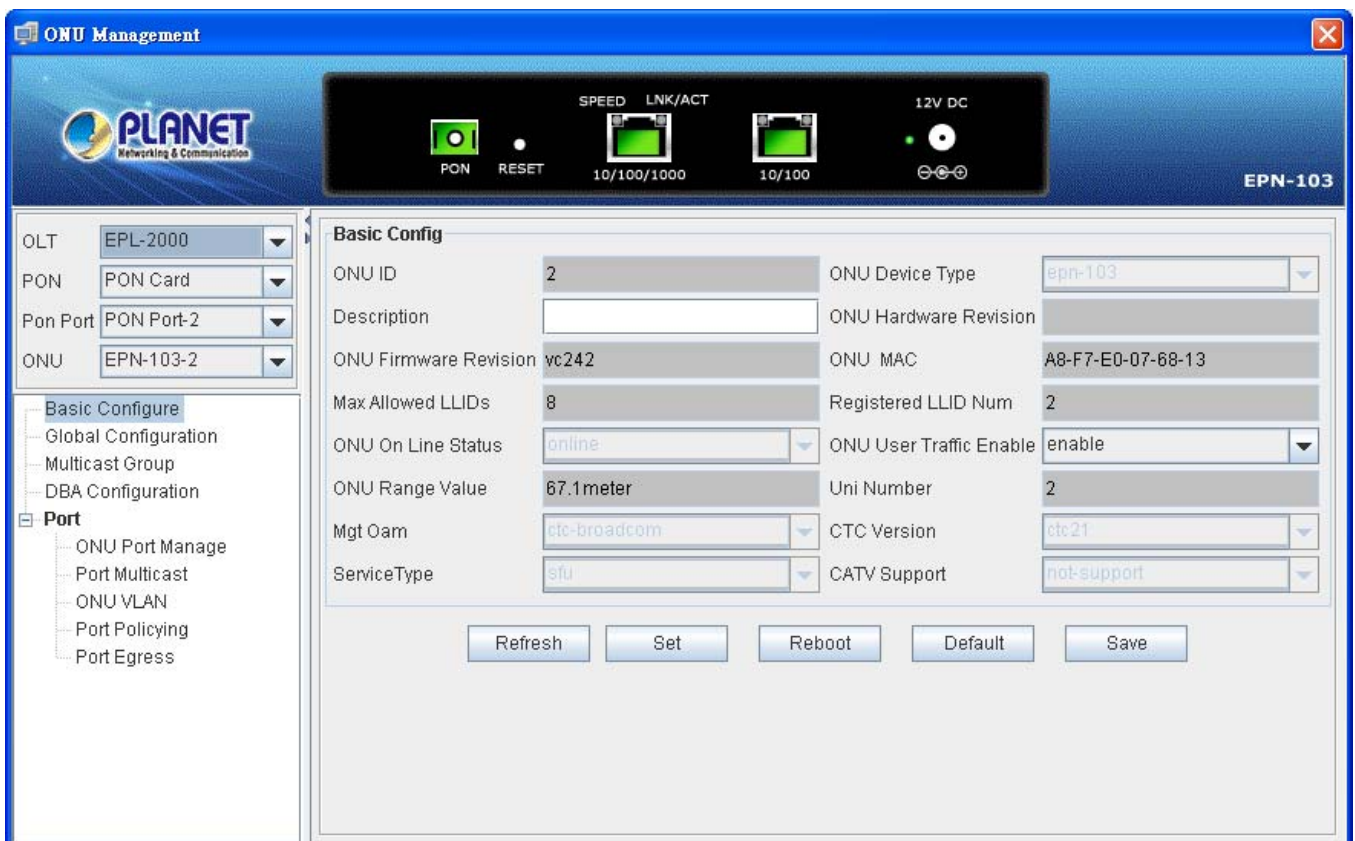

Figure 4-39 ONU Management Screen

## 4.4.1 Basic Configuration

The Basic System page provides information on the current device status. Basic System page helps an OLT administrator to identify the ONU device's firmware/hardware version, ONU MAC Address, ONU Line Status and others.

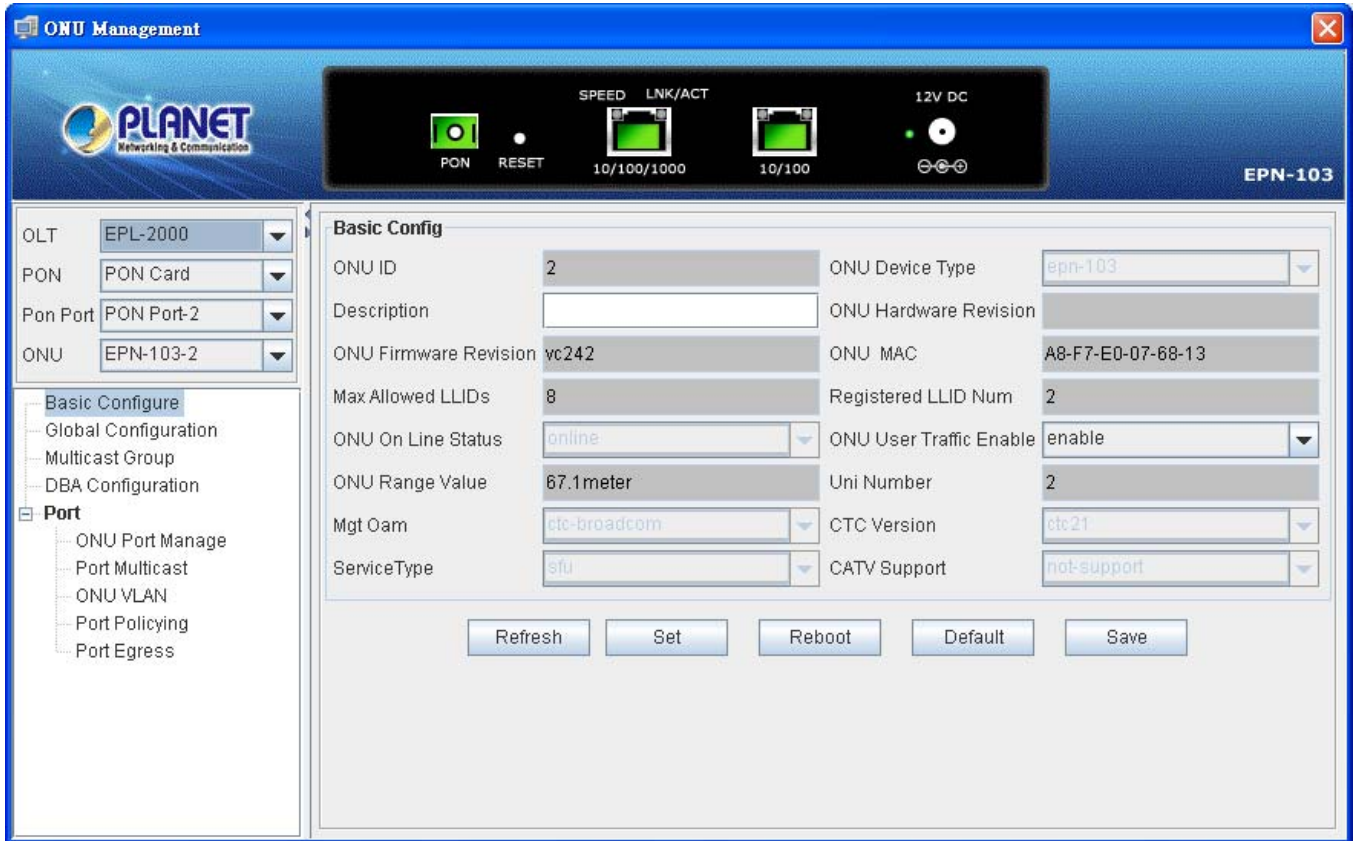

Figure 4-40 Basic Configuration Screen

The window includes the following fields:

Object	Description
<b>ONU ID:</b>	Number of ONU Devices detected by EMS Utility.
<b>ONU Device Type:</b>	Model name of ONU device.
<b>Description:</b>	Allows user to fill in the words for ONU description
<b>ONU Hardware Revision:</b>	Displays the ONU Hardware Version.
<b>ONU Software Revision:</b>	Displays the ONU Firmware Version.
<b>Max Allowed LLIDs:</b>	Displays the ONU MAX
<b>Registered LLID Num:</b>	Displays the registered LLID Number of ONU.
<b>ONU On Line Status:</b>	Displays the current ONU status.
<b>ONU User Traffic Enable:</b>	Enable: Allows user to transfer data via port. Disable: User is not allowed to transfer data via port.

<b>ONU Range Value:</b>	Displays the distances from OLT to ONU. (Short cabling would make detection difficult.)
<b>Uni Number:</b>	Displays the ONU Uni unnumber.
<b>Mgt Oam:</b>	Displays the ONU OAM management type.
<b>CTC Version:</b>	Displays the CTC version.
<b>Service Type:</b>	Displays the ONU service type.
<b>CATV Support:</b>	Displays the ONU CATV support type.

### 4.4.2 Global Parameter

This page allows user to configure the IGMP Fastleave, IPTV Profile, etc.

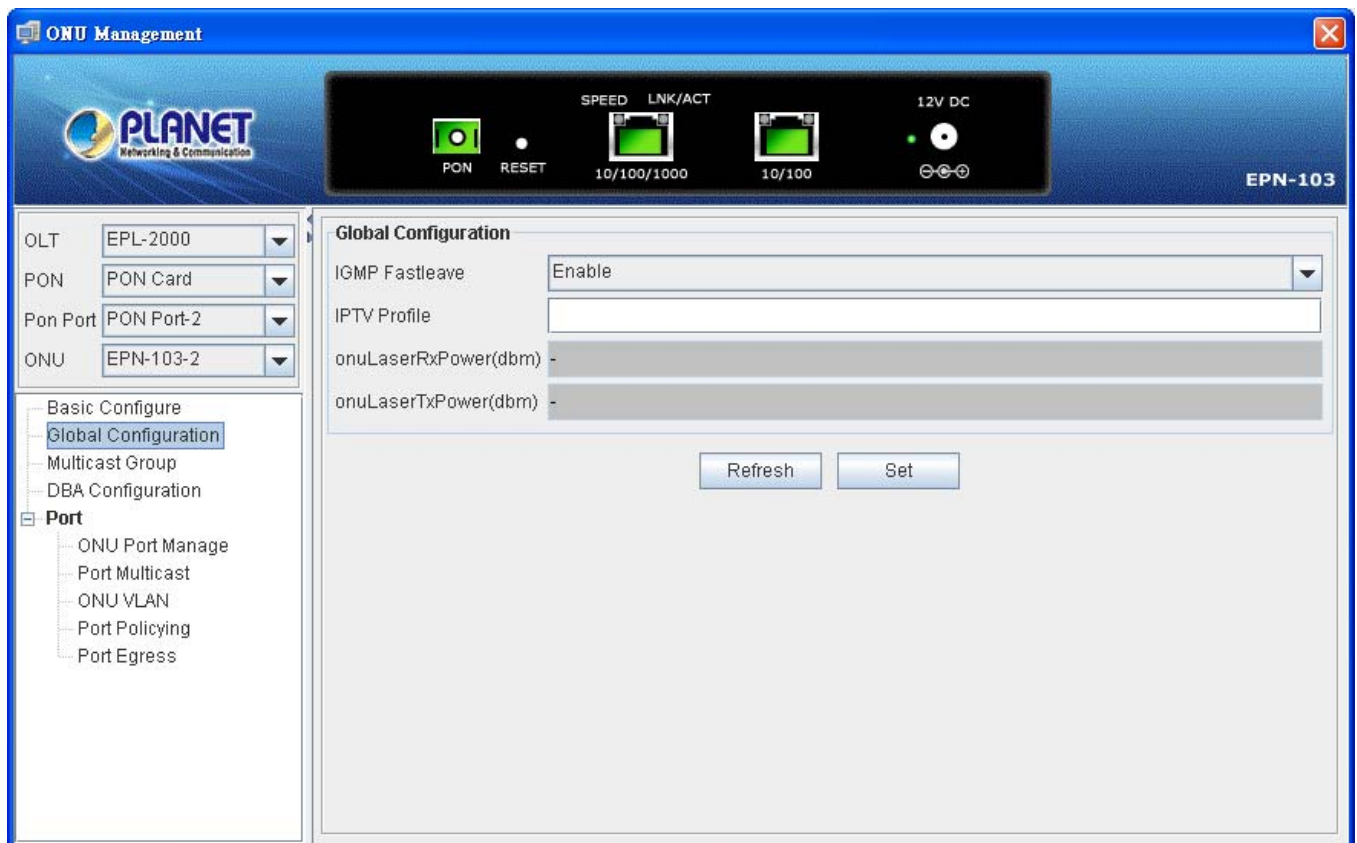

Figure 4-41 Global Parameter Screen

The window includes the following fields:

Object	Description
<b>IGMP Fastleave:</b>	<b>Enable:</b> Open the ONU IGMP Fastleave function. <b>Disable:</b> Close the ONU IGMP Fastleave function.
<b>IPTV Profile:</b>	Fill out the IPTV Profile name which has created from EPL-2000 IPTV Profile

	page.
<b>onuLaserRXPower(dbm):</b>	Displays the ONU Fiber Laser RX power.
<b>onuLaserTXPower(dbm):</b>	Displays the ONU Fiber Laser TX power.

### 4.4.3 ONU Multicast Group

This page displays all of your multicast connection information.

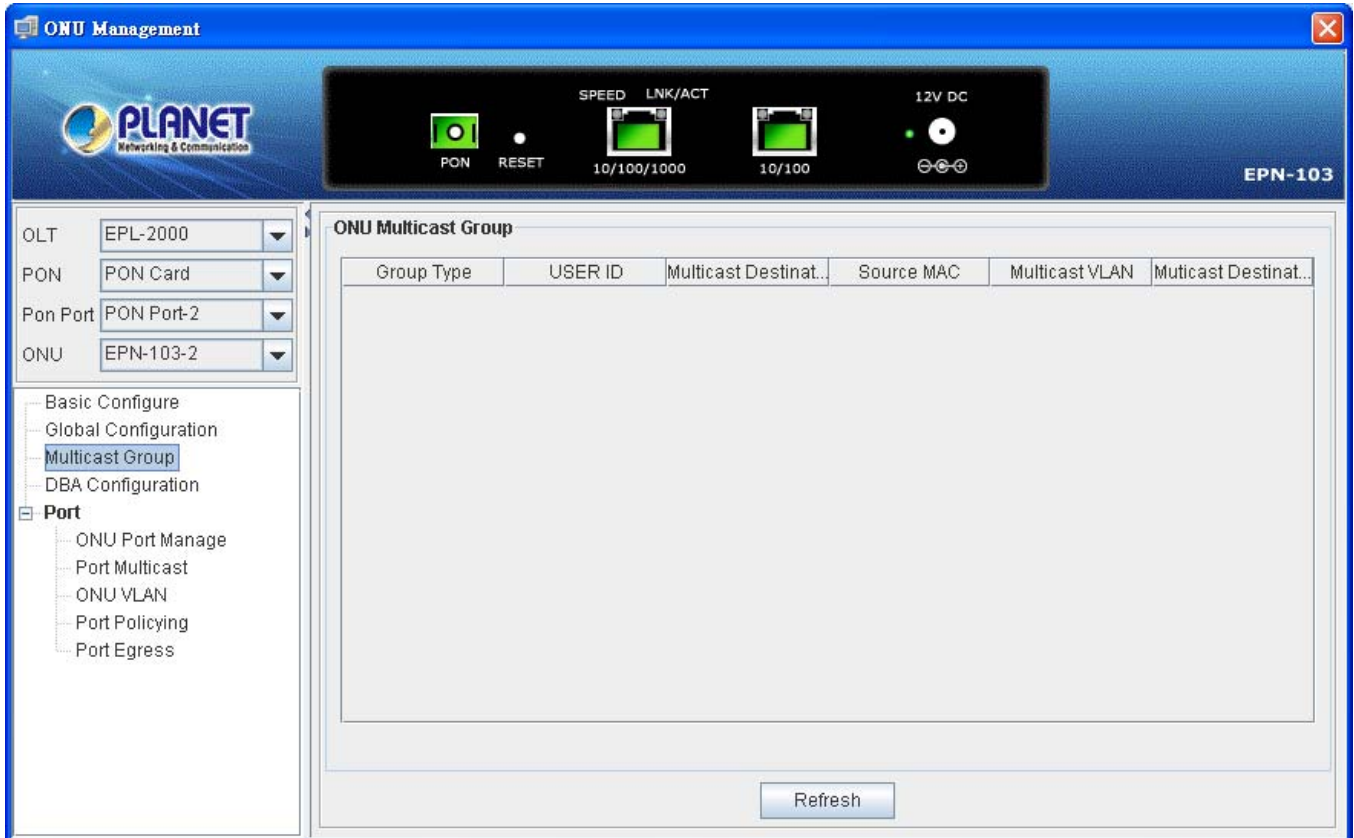

Figure 4-42 Global Parameter Screen

### 4.4.4 DBA Configuration (Only for EPN-103)

This page allows to configure the ONU speed rate.

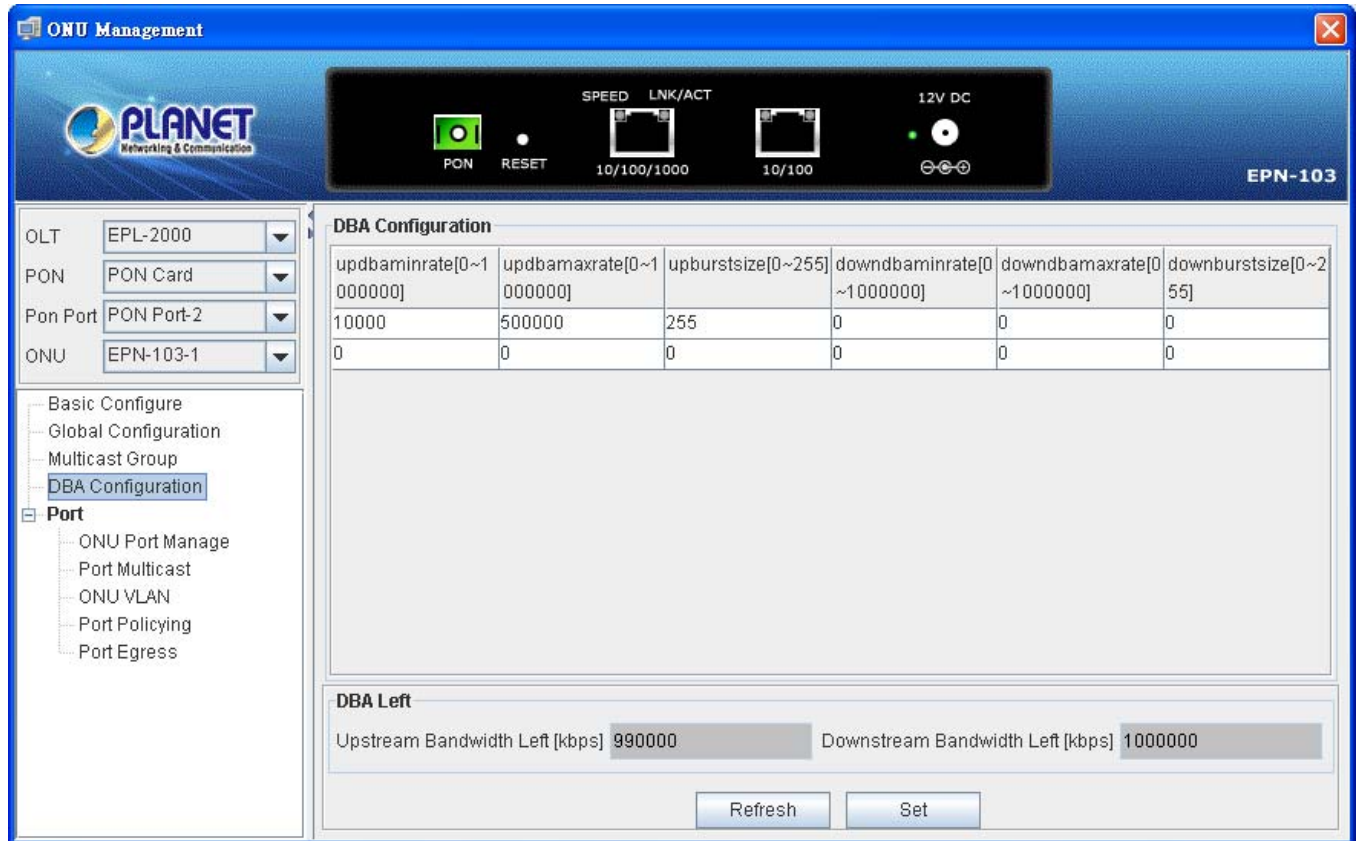

Figure 4-43 DBA Configuration Screen

The window includes the following fields:

Object	Description
<b>Updbaminrate[0~1000000]</b>	Enter the minimum upload rate which is allowed for the ONU Gigabit port and Fast Ethernet port. The allowed range is 0 bytes to 1000000 bytes.
<b>Updbamaxrate[0~1000000]</b>	Enter the maximum upload rate which is allowed for the ONU Gigabit port and Fast Ethernet port. The allowed range is 0 bytes to 1000000 bytes.
<b>Upburstsize[0~255]</b>	Enter the upload burst size; the default can be configured as 255.
<b>Downdbaminrate[0~1000000]</b>	Enter the maximum download rate which is allowed for the ONU Gigabit port and Fast Ethernet port. The allowed range is 0 bytes to 1000000 bytes.
<b>Downdbamaxrate[0~1000000]</b>	Enter the maximum download rate which is allowed for the ONU Gigabit port and Fast Ethernet port. The allowed range is 0 bytes to 1000000 bytes.
<b>downburstsize[0~255]</b>	Enter the download burst size; the default can be configured as 255.



### 4.4.5 ONU Port Management

In ONU Port Management, you can configure the settings of ONU ports to control the connection parameters like Port Speed, Duplex mode, Flow Control and Port Auto-Negotiation.

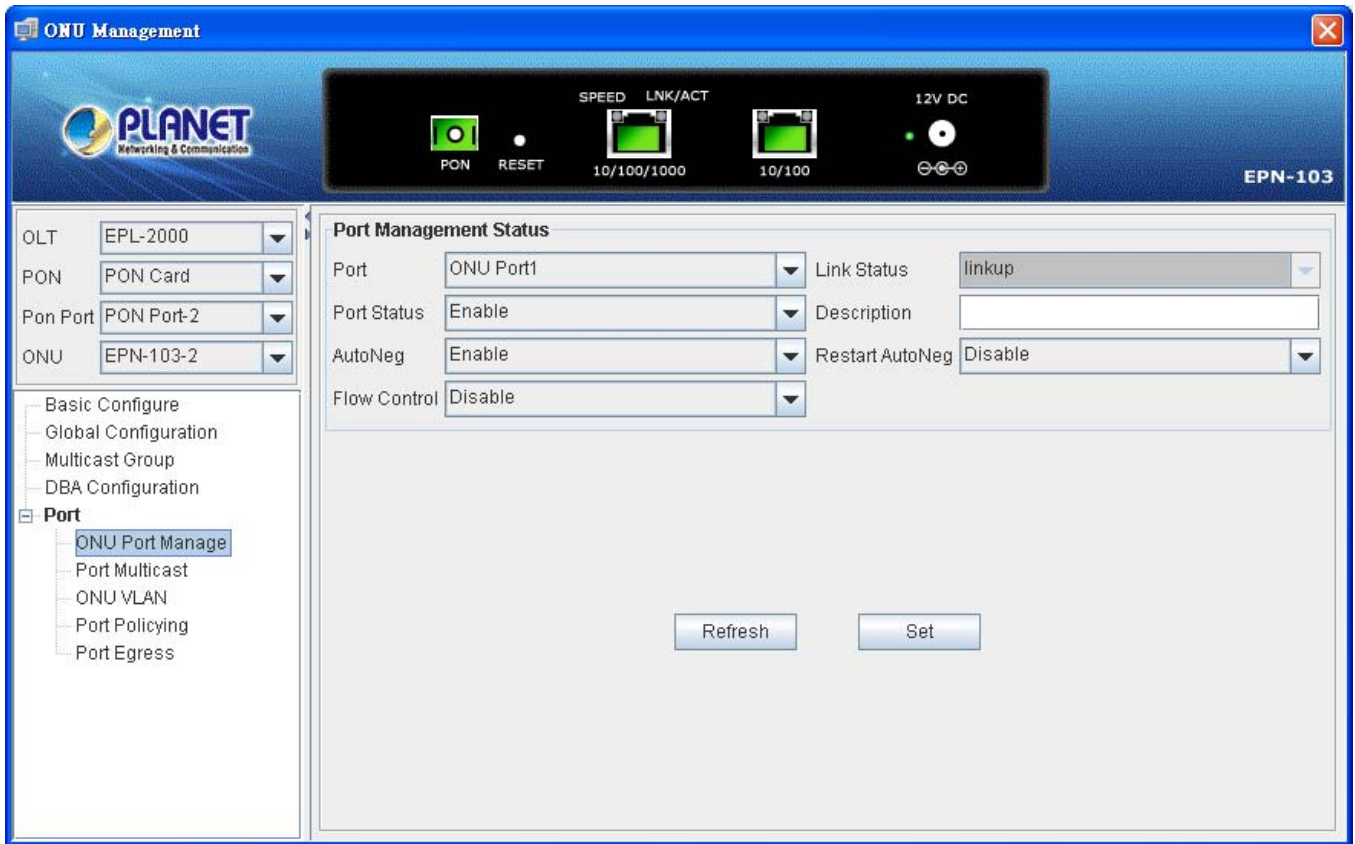

Figure 4-44 ONU Port Management Screen

The window includes the following fields:

Object	Description
<b>Port:</b>	ONU Port1: 10/100/1000Mbps Port. ONU Port2: 10/100Mbps Port.
<b>Link Status:</b>	Indicates the ONU current ethernet Port stauts.
<b>Port Status:</b>	<b>Enable:</b> Open the ONU Port1/2 stauts. <b>Disable:</b> Close the ONU Port1/2 stauts.
<b>Description:</b>	Allows user to fill in the words for ONU port 1 or 2 description
<b>AutoNeg:</b>	<b>Enable:</b> Open the ONU Port1/2 Auto-Negotiation. <b>Disable:</b> Close the ONU Port1/2 Auto-Negotiation.
<b>Restart AutoNeg:</b>	<b>Enable:</b> Allows for restarting the ONU Port1/2 Auto-Negotiation. <b>Disable:</b> Not allows for restarting the ONU Port1/2 Auto-Negotiation.
<b>Flow Control:</b>	It is available for selecting when the Negotiation column is set as Disable. When the Negotiation column is set as Enable, this column is read-only.

### 4.4.6 Port Multicast

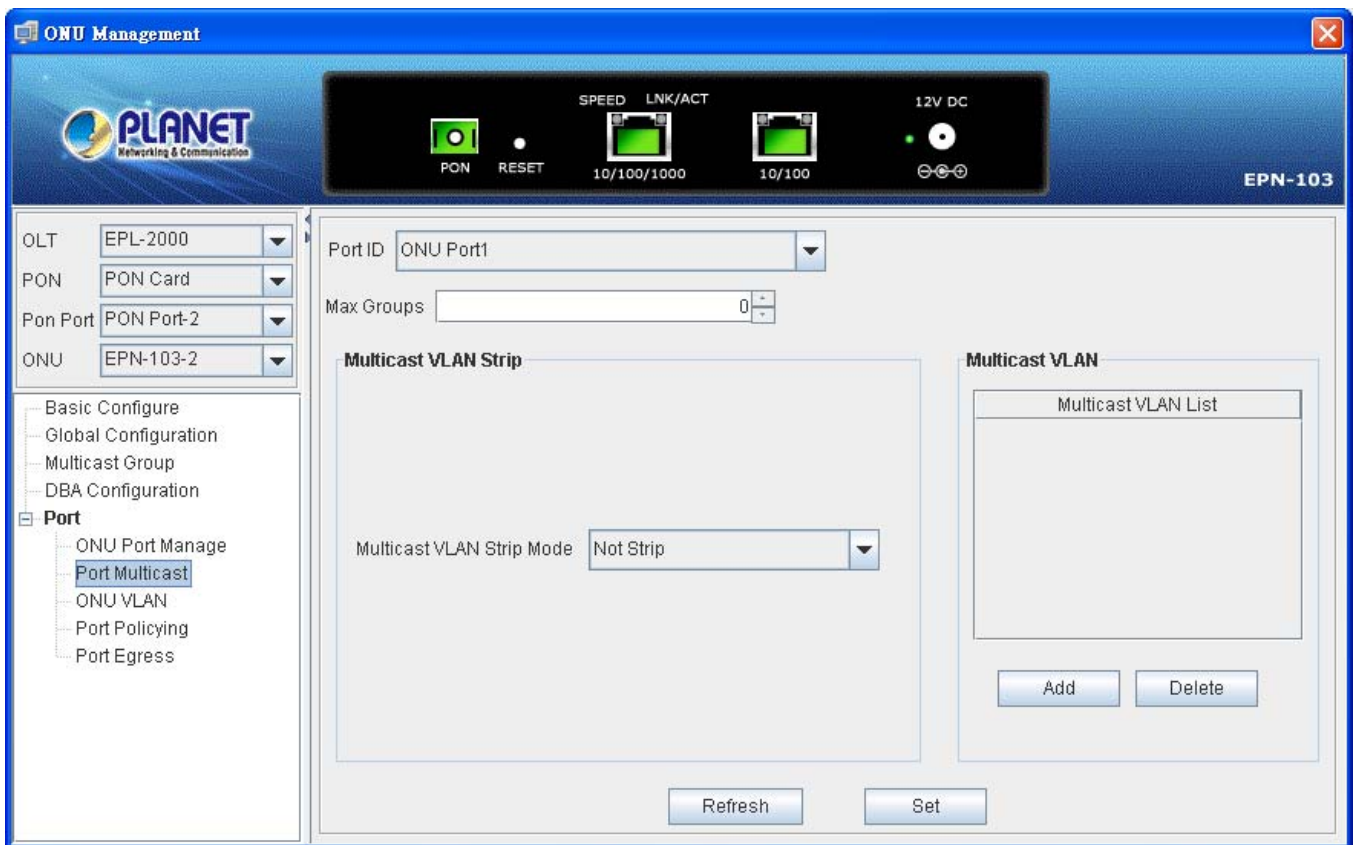

Figure 4-45 ONU Bridging Mode Screen

The window includes the following fields:

Object	Description
<b>Port ID:</b>	ONU Port1: 10/100/100Mbps Port. ONU Port2: 10/100Mbps Port.
<b>Max Groups:</b>	Allows user to configure how many groups.
<b>Multicast VLAN Strip Mode:</b>	Allows user to configure the mode of VLAN strip.
<b>Multicast VLAN list:</b>	List of Multicast VLANs.



### 4.4.7 ONU VLAN

This page allows the user to modify per port VLAN mode.

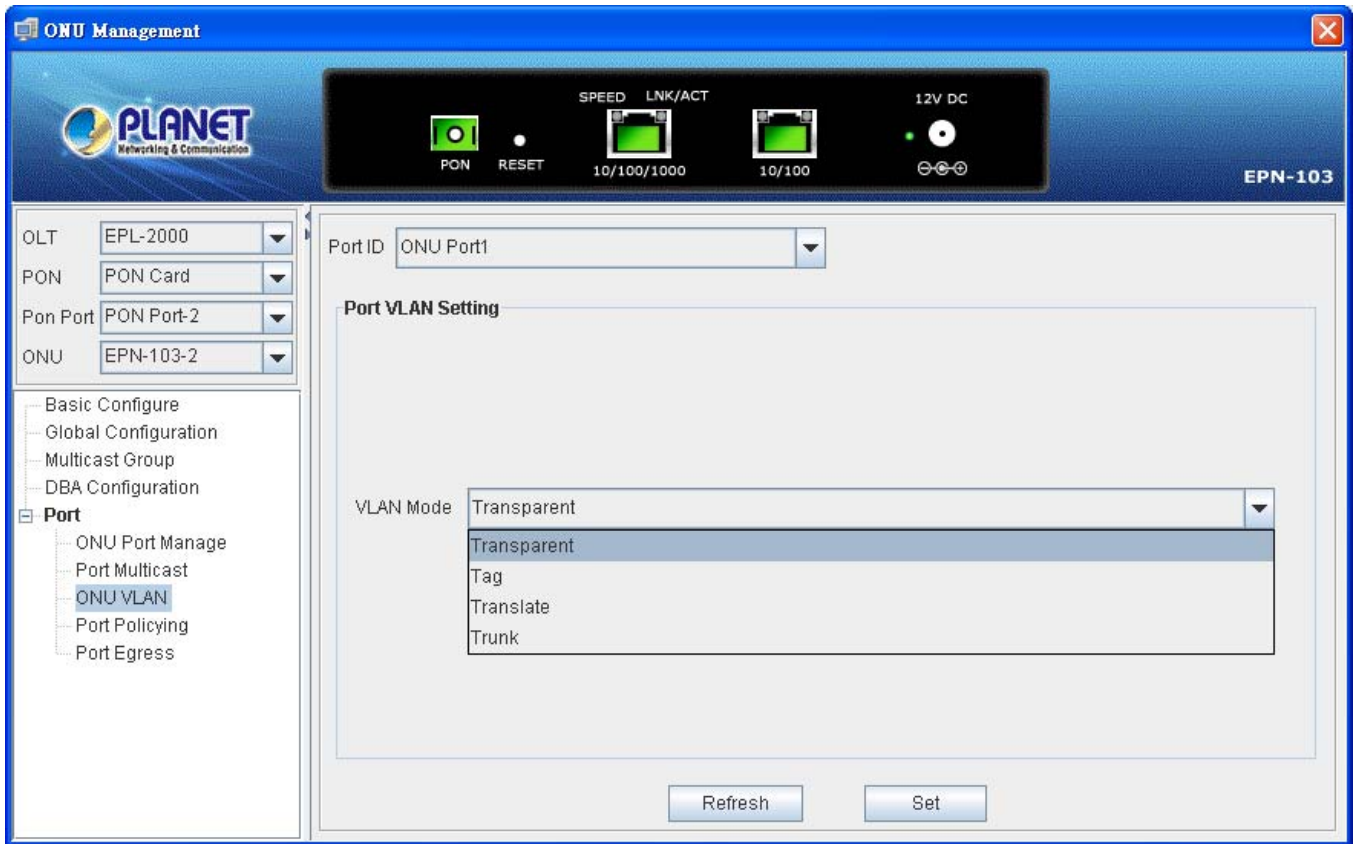

Figure 4-46 MAC Address Management Screen

The window includes the following fields:

Object	Description
<b>Port ID:</b>	ONU Port1: 10/100/100Mbps Port. ONU Port2: 10/100Mbps Port.
<b>VLAN Mode:</b>	There are four modes: <b>Transparent, Tag, Translate and Trunk modes.</b>

### 4.4.8 Port Policing

This page allows user to modify the Port Policy configuration.

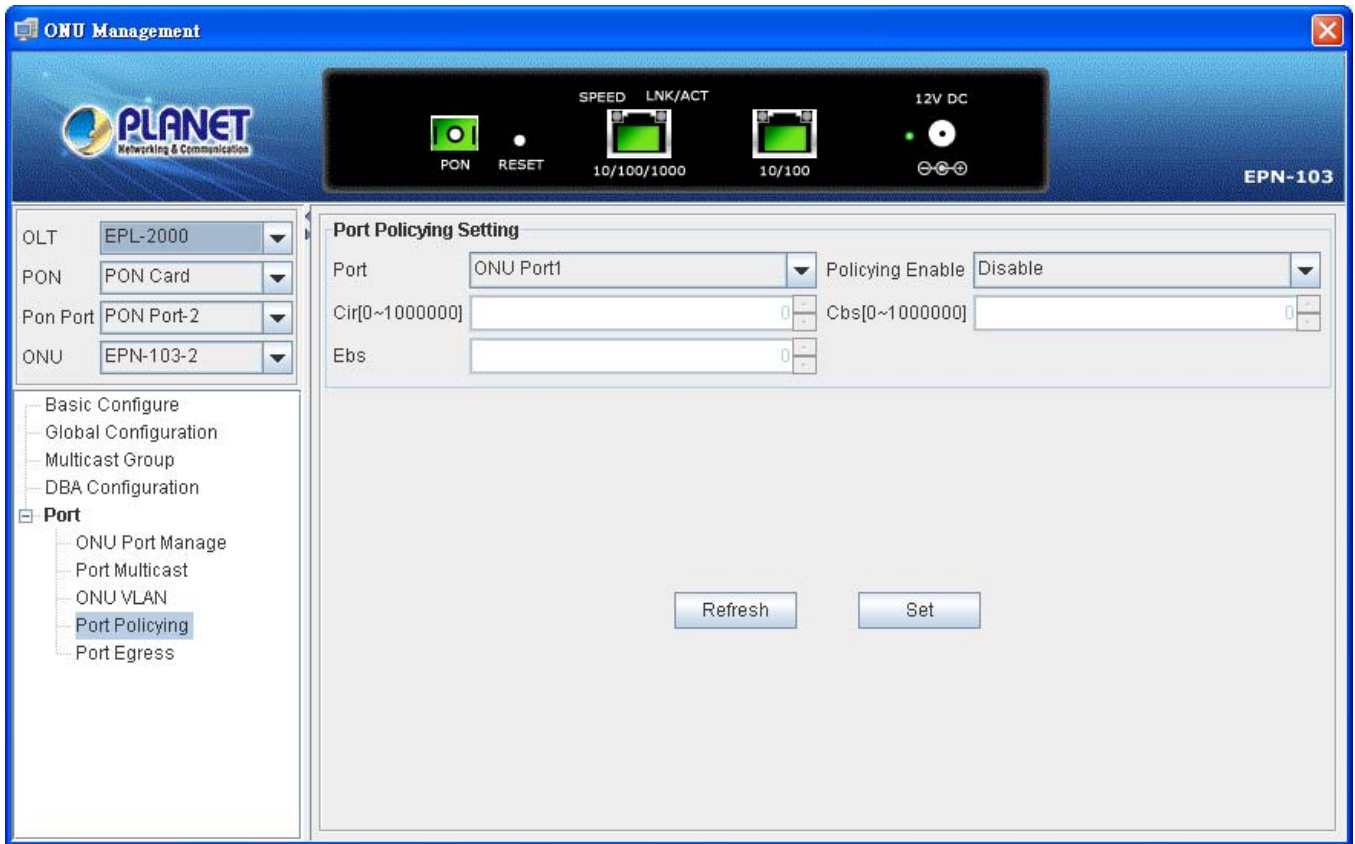

Figure 4-47 Port Policing Screen

The window includes the following fields:

Object	Description
<b>Port:</b>	ONU Port1: 10/100/1000Mbps Port. ONU Port2: 10/100Mbps Port.
<b>Policy Enable:</b>	Allows user Disable or Enable the Policy mode.
<b>Cir[0-1000000]:</b>	Allows user to fill out the Cir value, the range 0~1000000.
<b>Cbs[0-1000000]:</b>	Allows user to fill out the Cbs value, the range 0~1000000.
<b>Ebs:</b>	Allows user to fill out the Ebs value.

### 4.4.9 Port Egress

This page allows user to modify the Port Egress configuration.

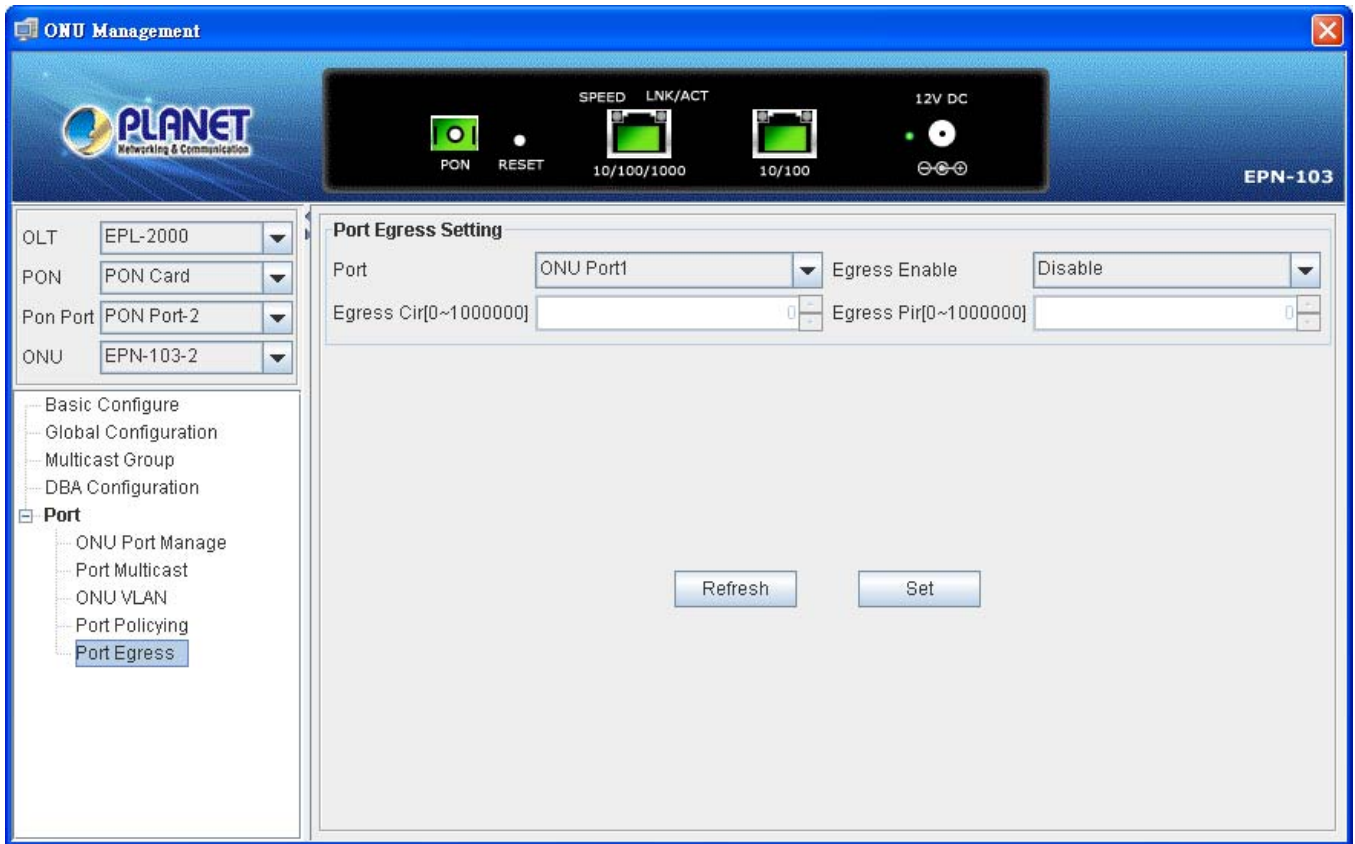

Figure 4-48 Port Egress Screen

The window includes the following fields:

Object	Description
<b>Port:</b>	ONU Port1: 10/100/1000Mbps Port. ONU Port2: 10/100Mbps Port.
<b>Egress Enable:</b>	Allows user Disable or Enable the Egress mode.
<b>Egress Cir[0-1000000]:</b>	Allows user to fill out the Egress Cir value, the range 0~1000000.
<b>Egress Pir[0-1000000]:</b>	Allows user to fill out the Egress Pir value, the range 0~1000000.

## 4.5 How to upgrade EPL-2000 firmware

For upgrading the EPL-2000 firmware, you need to have FTP server software. Here we are using Home FTP Server software for an example:

1. The following main screen of Home FTP Server appears:

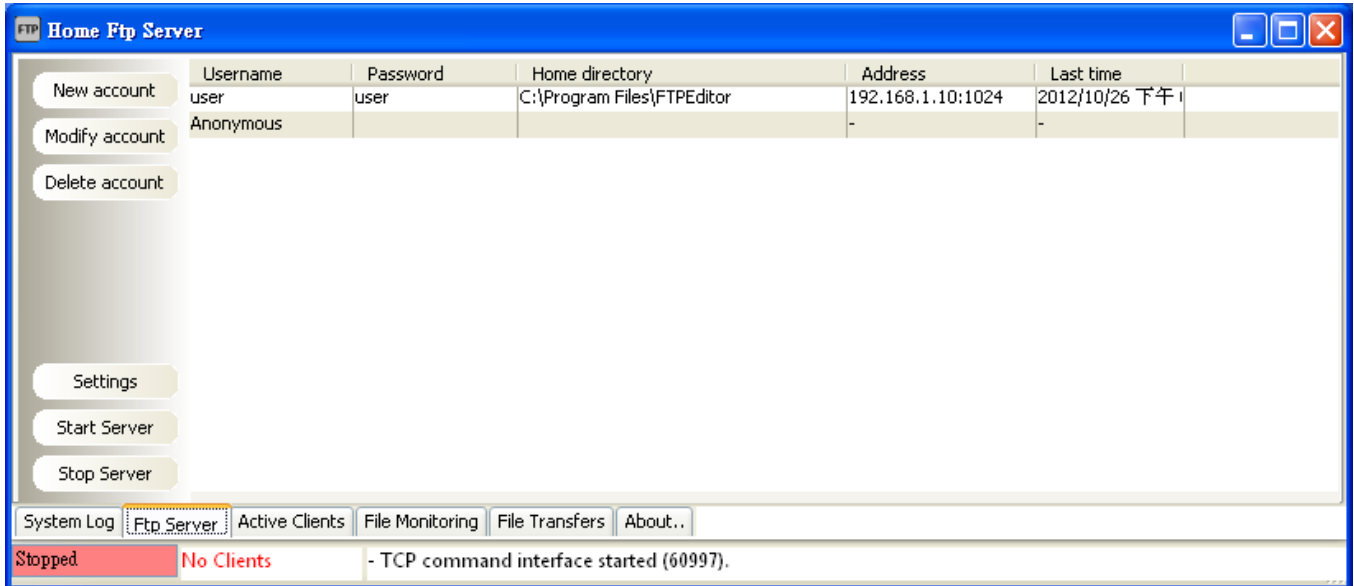

Figure 4-49 Home FTP Server Main Screen

2. Press the **"New account"** on the left column and the FTP Client Editor window appears below . Please fill in the user name and password as **"user"**.

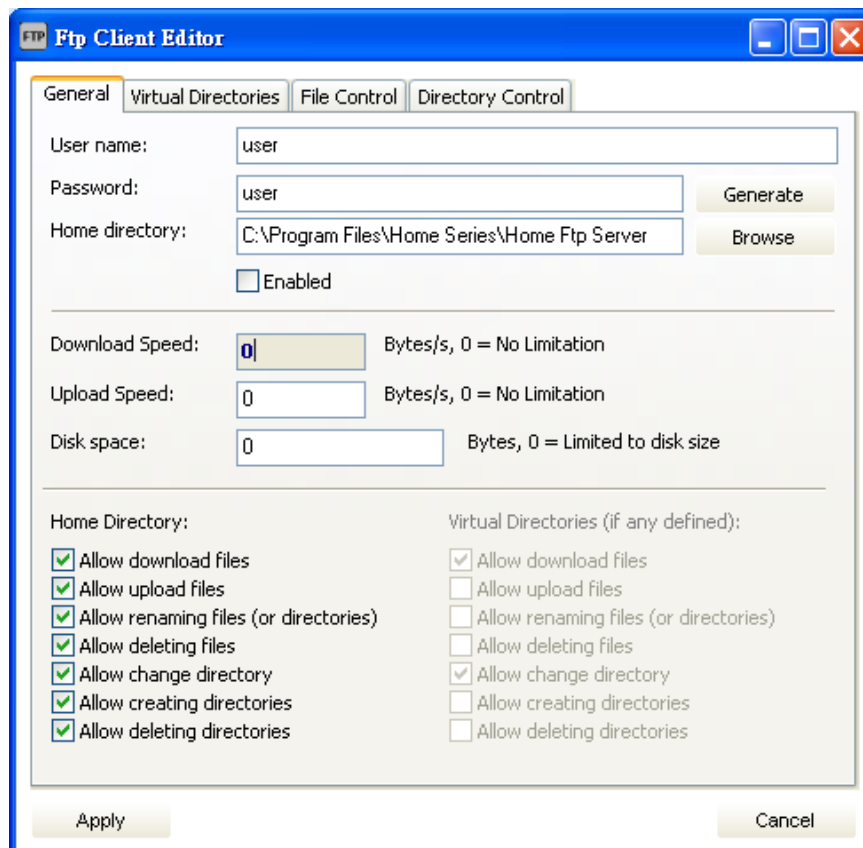

Figure 4-50 FTP Client Editor Screen

3. Execute "Start Server" for making connection establish.

4. Copy the EPL-2000 firmware to the Home Ftp server directory.

For example: C:\Program Files\Home Series\Home Ftp Server

5. Operate EMS utility → click EPL-2000 once → excute "Device Upgrade" on the EMS toolbar of Config.

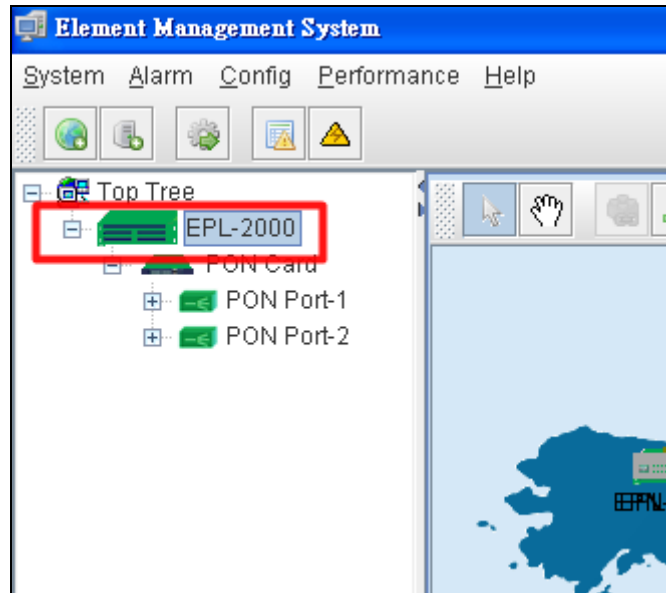

Figure 4-51 EPL-2000 Interface Screen

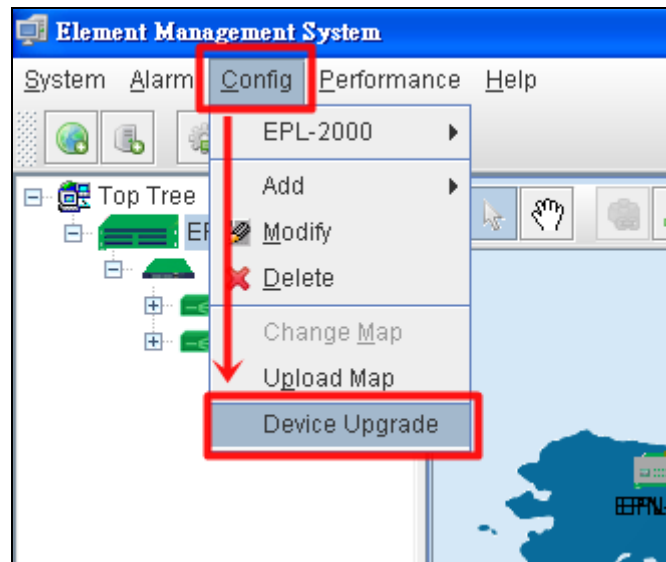

Figure 4-52 Device Upgrade Item Screen

6. After executing the Device Upgrade, the following window will appear. Please fill in the user name and password as "user".

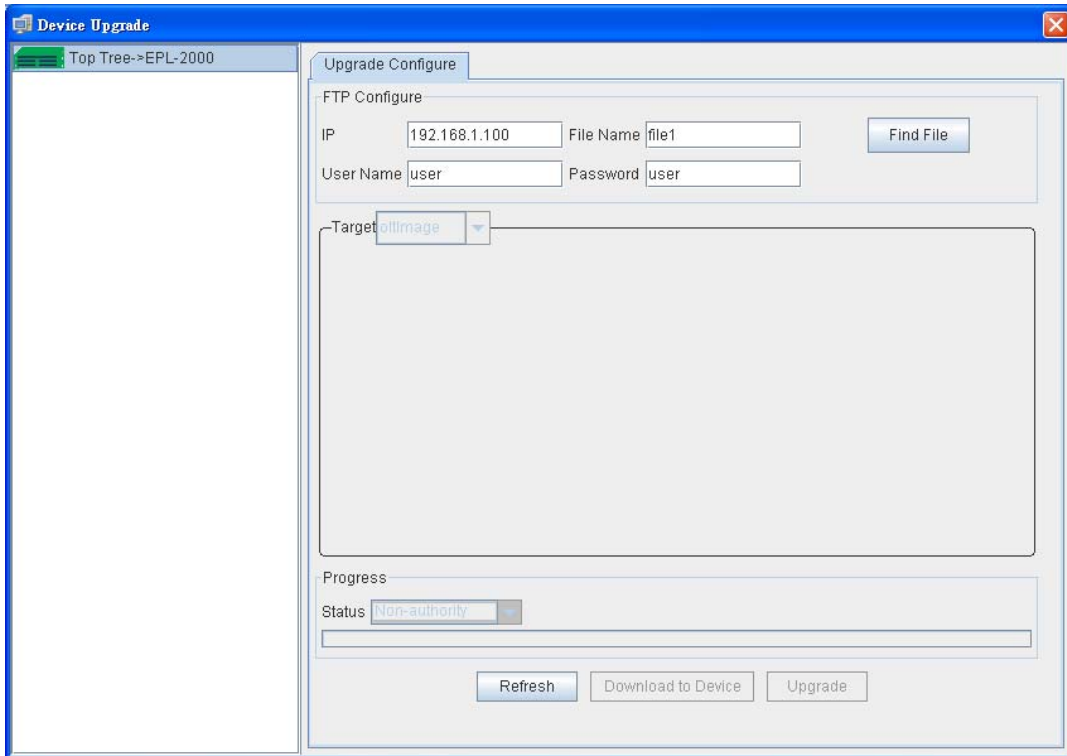

Figure 4-53 Device Upgrade Procedure (1) Screen

7. Press the "Find File" button to get EPL-2000 firmware. Following Step 3, the file should be at "C:\Program Files\Home Series\Home Ftp Server".

8. Press the "Download to Device" button for downloading the firmware. After a couple of seconds, the Progress Status "TransmitOK" will appear like the window below:

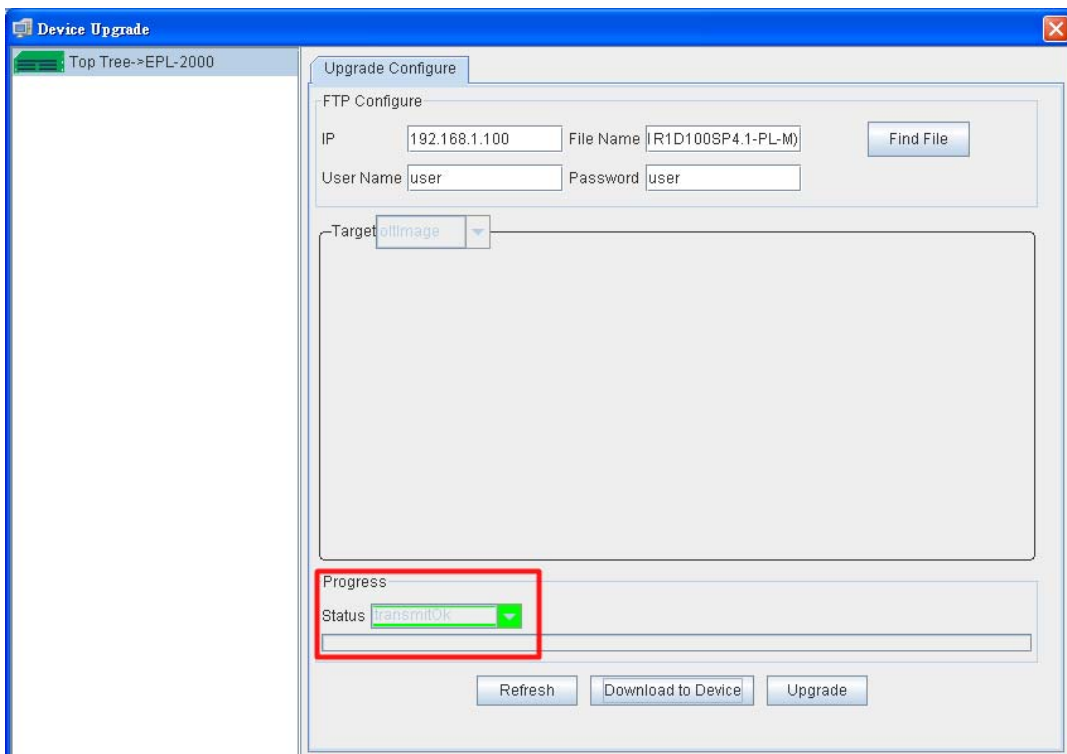

Figure 4-54 Device Upgrade Procedure (2) Screen

9. Press the "Upgrade" button for upgrading the firmware. During the period, the Progress Status will show "Upgrading". After finishing the upgrading, the Progress Status will show "Upgrade OK".

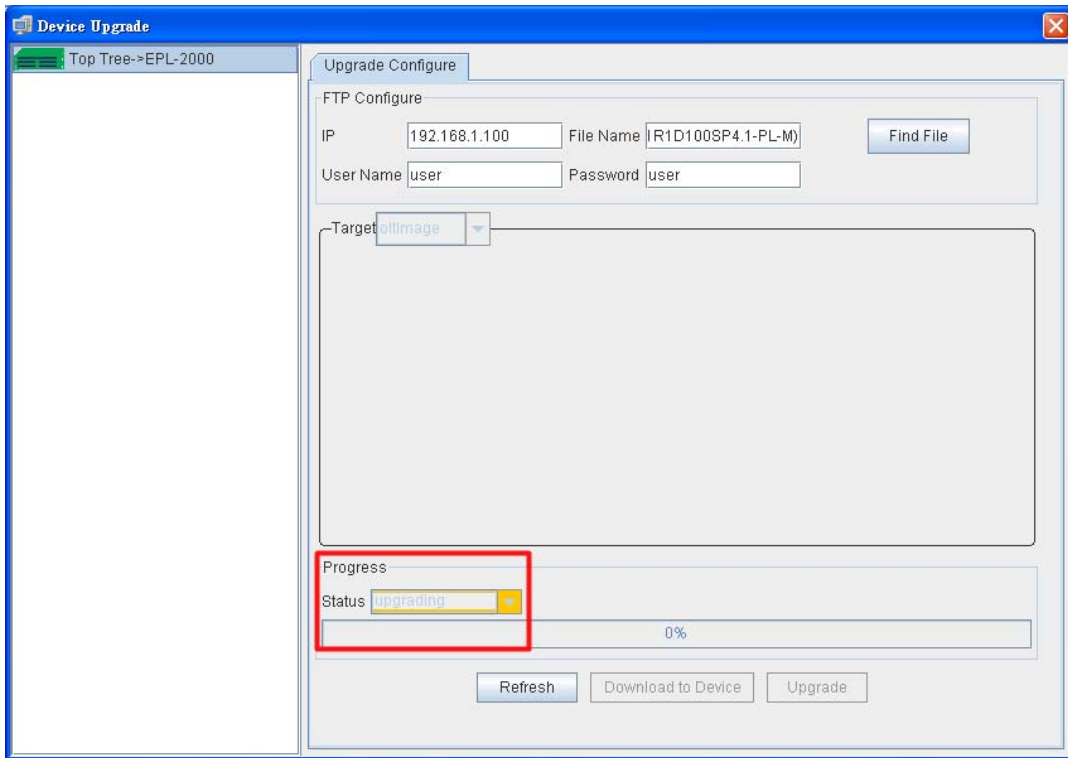

Figure 4-55 Device Upgrade Procedure (3) Screen

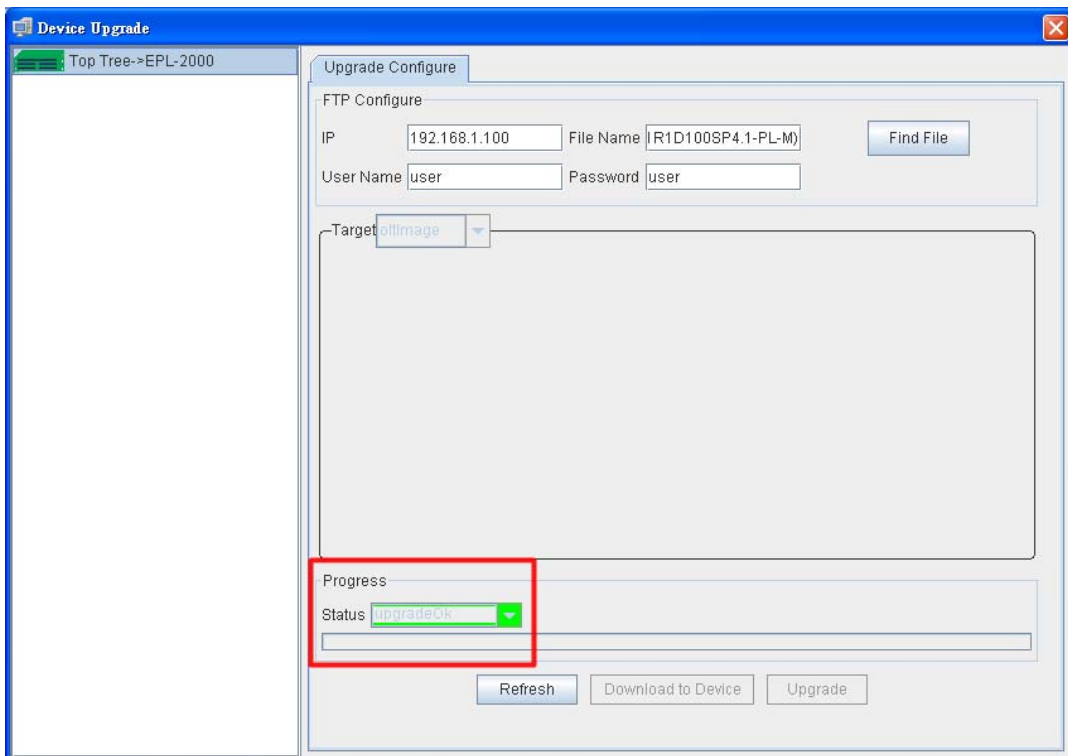

Figure 4-56 Device Upgrade Procedure (4) Screen

10. After finishing the firmware upgrade, please reboot the EPL-2000.

## 5. EPL-2000 OPERATION

### 5.1 Address Table

The OLT switch is implemented with an address table. This address table is composed of many entries. Each entry is used to store the address information on some nodes on the network, including MAC address, port number, etc.

### 5.2 Learning

When one packet comes in from any port, the OLT Switch will record the source address, port number, and other related information in the address table. This information will be used to decide either forwarding or filtering for future packets.

### 5.3 Forwarding & Filtering

When one packet comes from some port of the Ethernet Switching, it will also check the destination address besides the source address learning. The OLT Switch will look up the address table for the destination address. If not found, this packet will be forwarded to all the other ports except the port, which this packet comes in. And these ports will transmit this packet to the network it connected. If found, and the destination address is located at a different port from this packet comes in, the OLT Switch will forward this packet to the port where this destination address is located according to the information from the address table. But, if the destination address is located at the same port with this packet that comes in, then this packet will be filtered, thereby increasing the network throughput and availability

### 5.4 Auto-Negotiation

The STP ports on the Switch have built-in "Auto-negotiation". This technology automatically sets the best possible bandwidth when a connection is established with another network device (usually at Power On or Reset). This is done by detecting the modes and speeds at the second of both devices are connected and capable of. Both 10BASE-T and 100BASE-TX devices can connect with the port in either Half- or Full-Duplex mode.

If attached device is:	100BASE-TX port will set to:
10Mbps, no auto-negotiation	10Mbps.
10Mbps, with auto-negotiation	10/20Mbps (10BASE-T/Full-Duplex)
100Mbps, no auto-negotiation	100Mbps
100Mbps, with auto-negotiation	100/200Mbps (100BASE-TX/Full-Duplex)



## APPENDIX A

### A.1 Switch's RJ45 Pin Assignments

1000Mbps, 1000BASE-T

Contact	MDI	MDI-X
1	BI_DA+	BI_DB+
2	BI_DA-	BI_DB-
3	BI_DB+	BI_DA+
4	BI_DC+	BI_DD+
5	BI_DC-	BI_DD-
6	BI_DB-	BI_DA-
7	BI_DD+	BI_DC+
8	BI_DD-	BI_DC-

Implicit implementation of the crossover function within a twisted-pair cable, or at a wiring panel, while not expressly forbidden, is beyond the scope of this standard.

### A.2 10/100Mbps, 10/100BASE-TX

When connecting your 10/100Mbps Ethernet Switch to another switch, a bridge or a hub, a straight or crossover cable is necessary. Each port of the Switch supports auto-MDI/MDI-X detection. That means you can directly connect the Switch to any Ethernet devices without making a crossover cable. The following table and diagram show the standard RJ45 receptacle/connector and their pin assignments:

RJ45 Connector pin assignment		
Contact	MDI Media Dependent Interface	MDI-X Media Dependent Interface-Cross
1	Tx + (transmit)	Rx + (receive)
2	Tx - (transmit)	Rx - (receive)
3	Rx + (receive)	Tx + (transmit)
4, 5	Not used	
6	Rx - (receive)	Tx - (transmit)
7, 8	Not used	

The standard cable, RJ45 pin assignment

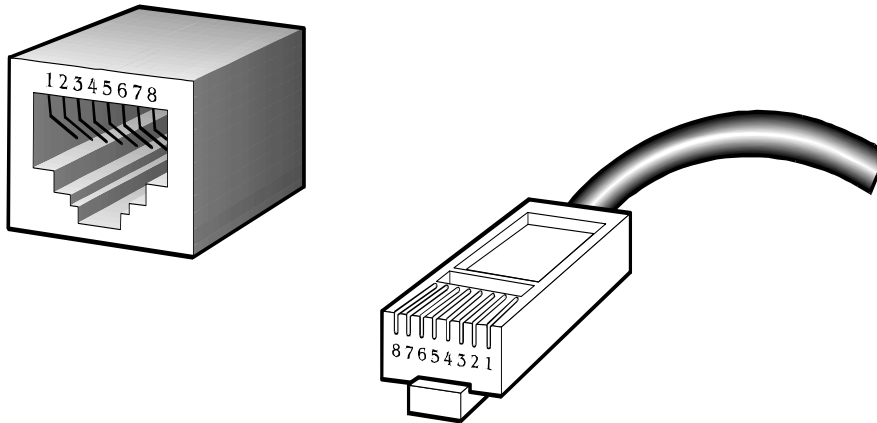

The standard RJ45 receptacle/connector

There are 8 wires on a standard UTP/STP cable and each wire is color-coded. The following shows the pin allocation, color of straight cable and crossover cable connection:

Straight Cable		SIDE 1	SIDE 2						
1	2	3	4	5	6	7	8	SIDE 1 1 = White / Orange 2 = Orange 3 = White / Green 4 = Blue 5 = White / Blue 6 = Green 7 = White / Brown 8 = Brown  SIDE 2 1 = White / Orange 2 = Orange 3 = White / Green 4 = Blue 5 = White / Blue 6 = Green 7 = White / Brown 8 = Brown	SIDE 1 1 = White / Orange 2 = Orange 3 = White / Green 4 = Blue 5 = White / Blue 6 = Green 7 = White / Brown 8 = Brown  SIDE 2 1 = White / Orange 2 = Orange 3 = White / Green 4 = Blue 5 = White / Blue 6 = Green 7 = White / Brown 8 = Brown
1	2	3	4	5	6	7	8		
1	2	3	4	5	6	7	8		
1	2	3	4	5	6	7	8		
1	2	3	4	5	6	7	8		
1	2	3	4	5	6	7	8		
1	2	3	4	5	6	7	8		
1	2	3	4	5	6	7	8		
Crossover Cable		SIDE 1	SIDE 2						
1	2	3	4	5	6	7	8	SIDE 1 1 = White / Orange 2 = Orange 3 = White / Green 4 = Blue 5 = White / Blue 6 = Green 7 = White / Brown 8 = Brown  SIDE 2 1 = White / Green 2 = Green 3 = White / Orange 4 = Blue 5 = White / Blue 6 = Orange 7 = White / Brown 8 = Brown	SIDE 1 1 = White / Orange 2 = Orange 3 = White / Green 4 = Blue 5 = White / Blue 6 = Green 7 = White / Brown 8 = Brown  SIDE 2 1 = White / Green 2 = Green 3 = White / Orange 4 = Blue 5 = White / Blue 6 = Orange 7 = White / Brown 8 = Brown
1	2	3	4	5	6	7	8		
1	2	3	4	5	6	7	8		
1	2	3	4	5	6	7	8		
1	2	3	4	5	6	7	8		
1	2	3	4	5	6	7	8		
1	2	3	4	5	6	7	8		
1	2	3	4	5	6	7	8		

Figure A-1: Straight-through and Crossover Cables

Please make sure your connected cables are with the same pin assignment and color as the above diagram before deploying the cables into your network.