

VERIFY THE CONTENTS INSIDE THE PACKAGE BOX

The package should contain the following items plus VIP-2020PT. If any item is missing or damaged, please contact the seller immediately.



Quick Guide



CD-ROM



Handset



Handset Cord



RJ-45 cable



Power Adapter



Stand

Step 1. Handset Connection

Plug one end of the handset cord into the handset and the other end into the handset jack

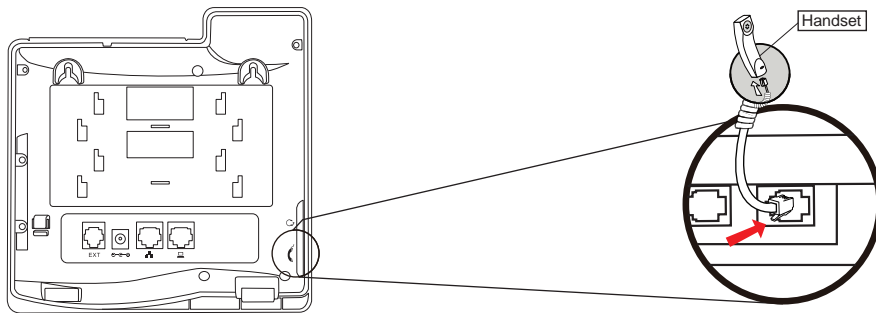

Step 2. Connecting Power System

The VIP-2020PT can be powered either by external AC/DC adapter or by connecting to an IEEE802.3af/at PSE device such as 802.3af Injector / Hub or 802.3af/at POE switch.

Once the VIP-2020PT is powered, the LCD screen will prompt for POST.

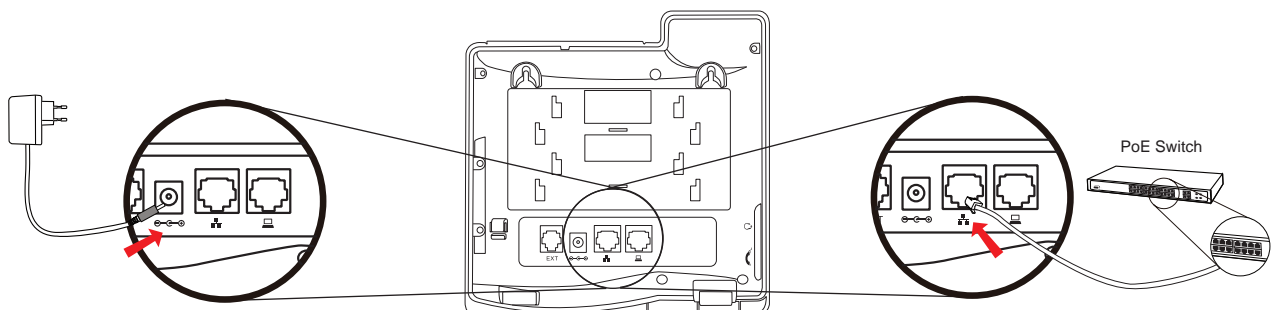

- NOTE :**
1. Use only the power adapter shipped with the unit to ensure correct functionality
 2. Only WAN supports POE.

Step 3. Connecting Network

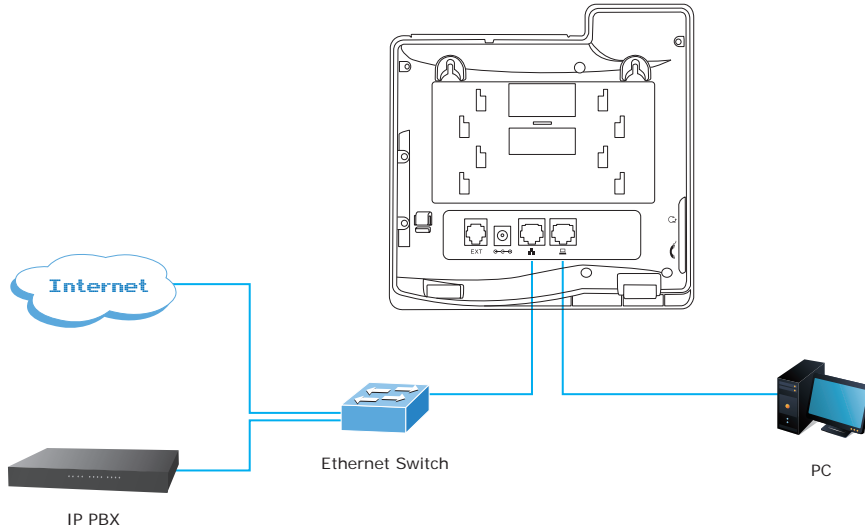

Step 4. Computer Network Setup

Set your computer's IP address to 192.168.0.x, where x is a number between 2 to 254 (except 1 where is being used for the phone by default). If you don't know how to do this, please ask your network administrator. Connect your PC to VIP-2020PT PC port.

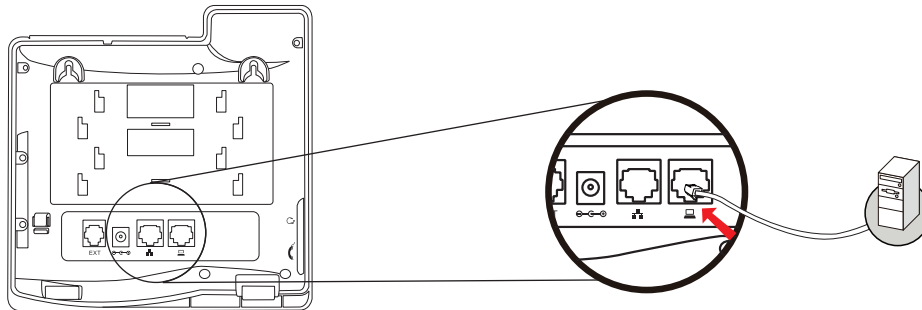

Step 5. Login Prompt

Use web browser (Internet Explorer 6.0 or above) to connect to 192.168.0.1 (type this address in the address bar of web browser).

You'll be prompted to input user name and password: **admin** and **123**



Further Configuration

For detailed configuration, please check user's manual on the bundled CD.

If you have any other question, please contact the dealer where you purchased this product or you can contact PLANET directly at the following: Email address: support@planet.com.tw