

**Industrial Wall-mount Managed
Gigabit Ethernet Switch**

WGS-804HPT/WGS-4215-8T

WGS-4215-8T2S/WGS-4215-8P2S/WGS-4215-16P2S

Quick Installation Guide

Table of Contents

1. Package Contents	3
2. Requirements	4
3. Wiring the Power Inputs.....	5
3.1 Terminal Block Connector Pinout	6
3.2 DC Power Jack	6
4. Hardware Installation	7
4.1 Wall-mount Installation.....	7
4.2 Magnet Installation	8
4.2.1 Magnet Installation of WGS-4215-16P2S	8
4.3 DIN-rail Mounting	9
5. Web Login.....	11
5.1 Starting Web Management.....	11
5.2 Saving Configuration via the Web.....	16
6. SSH Login.....	17
6.1 Configuring IP Address	19
6.2 Storing the Current Switch Configuration	20
7. Recovering Back to Default Configuration.....	21
8. Customer Support	22







1. Package Contents

Thank you for purchasing PLANET Industrial Wall-mount Managed Gigabit Switch, WGS-804HPT or WGS-4215 series. The table below shows the models with the number of ports:

Model Name	10/100/1000T Copper Ports	802.3at PoE Ports	100/1000 SFP Fiber Optic Interface
WGS-4215-8T	8	—	—
WGS-4215-8T2S	8	—	2
WGS-804HPT	8	4	—
WGS-4215-8P2S	8	8	2
WGS-4215-16P2S	16	16	2

In the following sections, unless specified, the term **“Wall-mount Managed Switch”** mentioned in this quick installation guide refers to the above models.

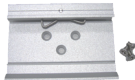
Open the box of the Wall-mount Managed Switch and carefully unpack it. The box should contain the following items:

The Wall-mount Managed Switch x 1	QR Code Sheet x 1 pc	3-pin Terminal Block Connector x 1 pc
 (Vary on the model)		
Wall-mounted Kit x 1 set	Magnet Kit x 1 set	DIN-rail Kit x 1 set
		
RJ45 Dust Cap x 8 pcs	SFP Dust Cap x 2 pcs	
 (x16 for WGS-4215-16P2S only)	 (WGS-4215-8T2S/WGS-4215-8P2S/ WGS-4215-16P2S only)	

If any item is found missing or damaged, please contact your local reseller for replacement.

2. Requirements

- **Workstations** running Windows 7/8/10/11, macOS 10.12 or later, Linux Kernel 2.6.18 or later, or other modern operating systems are compatible with TCP/IP Protocols.
- Workstations are installed with **Ethernet NIC** (Network Interface Card).
- **Ethernet Port Connection**
 - Network cables -- Use standard network (UTP) cables with RJ45 connectors.
 - The above PC is installed with **Web browser**.



Note

It is recommended to use Google Chrome, Microsoft Edge or Firefox to access the Wall-mount Managed Switch. If the Web interface of the Wall-mount Managed Switch is not accessible, please turn off the anti-virus software or firewall and then try it again.

3. Wiring the Power Inputs

The Wall-mount Managed Switch features a strong dual power input system (terminal block and DC jack) incorporated into customer's automation network to enhance system reliability and uptime.

Model	Power Input Range	3-pin Terminal Block	DC Jack
WGS-4215-8T		12~48V DC, 24V AC	12~48V DC, 24V AC
WGS-4215-8T2S		12~48V DC, 24V AC	12~48V DC
WGS-804HPT		48~54V DC	48~54V DC
WGS-4215-8P2S		48~54V DC	48~54V DC
WGS-4215-16P2S		48~54V DC	48~54V DC



Note

Maximum power requirements also rely on the real site application.

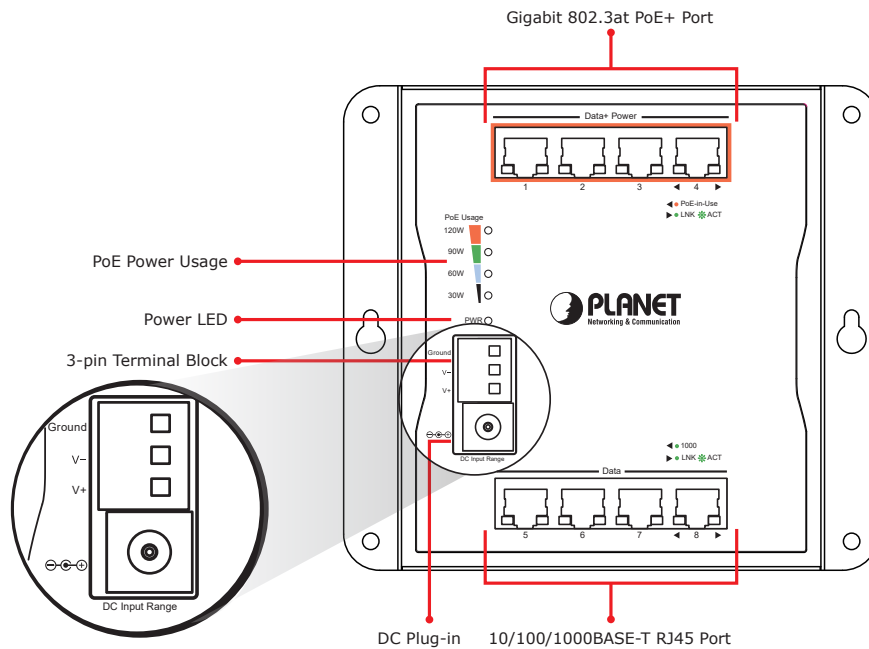

3.1 Terminal Block Connector Pinout

To install the 3-pin Terminal Block Connector on the Wall-mount Managed Switch, simply follow the following steps:

Step 1: Insert positive DC power wire into **V+**, negative DC power wire into **V-**, and grounding wire into **Ground**.

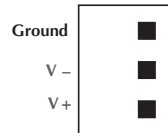

Step 2: Tighten the wire-clamp screws for preventing the wires from loosening and plug into the Wall-mount Managed switch.



Note

1. The wire gauge should be in the range from 12 to 24 AWG.
2. The device must be grounded.

3.2 DC Power Jack

The WGS-804HPT/WGS-4215 PoE models requires **DC 48V~54V** power input, and the WGS-4215-8T/WGS-4215-8T2S requires **DC 12~48V** power input. Should you have the issue of power connection, please contact your local sales representative.

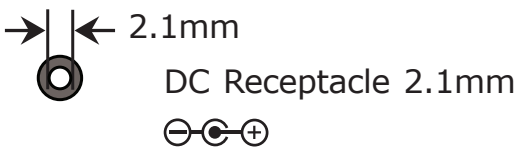

DC receptacle is 2.1mm wide that conforms to the WGS-4215 series 2.1mm DC jack's central post. Do not install any improper power adaptor.

4. Hardware Installation

4.1 Wall-mount Installation

To install the Wall-mount Managed Switch on the wall, simply follow the following steps:

Step 1: Drive four 8mm diameter holes into the wall horizontally with the distance between the 2 holes being 133mm (WGS-804HPT/WGS-4215-8T), 163mm (WGS-4215-8T2S/WGS-4215-8P2S) and 230mm (WGS-4215-16P2S) shown in the table below.

Step 2: Lightly hammer the wall anchors into the four holes.

Step 3: Place the unit on the wall where there are four holes, and screw the bolts into the wall anchors to finish the installation.

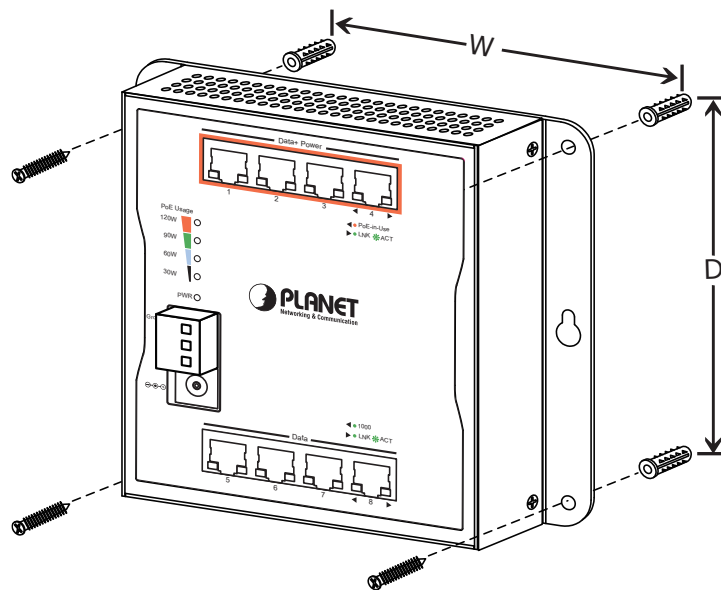

Hole sizes for mounting			
Distance (mm)	8-port	8+2S	16+2S
W	133	163	230
D	118	118	124

4.2 Magnet Installation

To install the Wall-mount Managed Switch on a magnetic surface, simply follow the following diagrams:

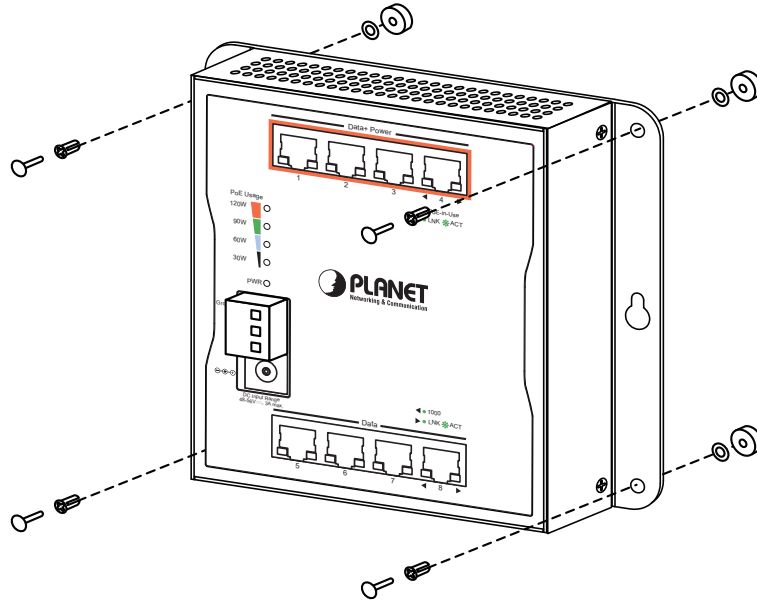

4.2.1 Magnet Installation of WGS-4215-16P2S

There are six holes on the unit, using six round magnets to install. Please refer to the following.

Step 1: Turn the switch to the back and place the six round magnets through the holes.

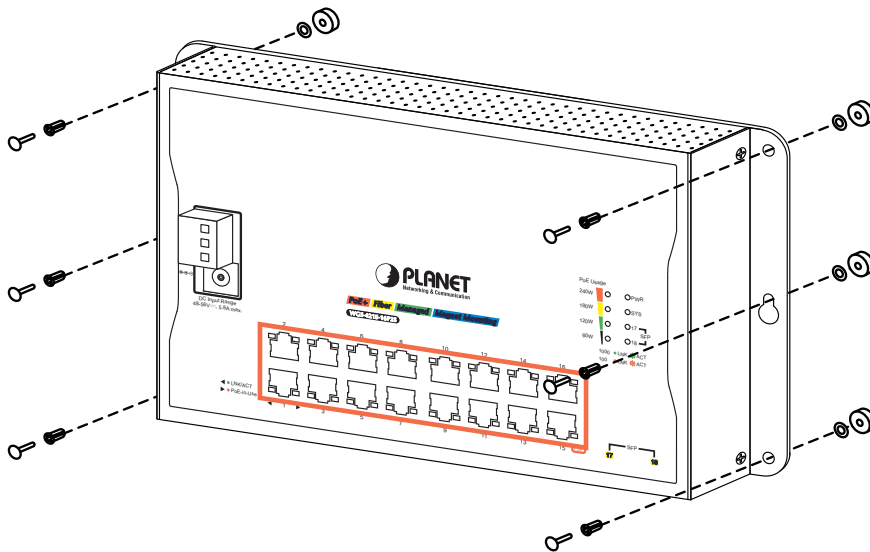

Step 2: Turn the switch to the front and push the plastic bolts into the holes to secure the magnets.

Step 3: One last round magnet should be fixed in the middle of the switch.

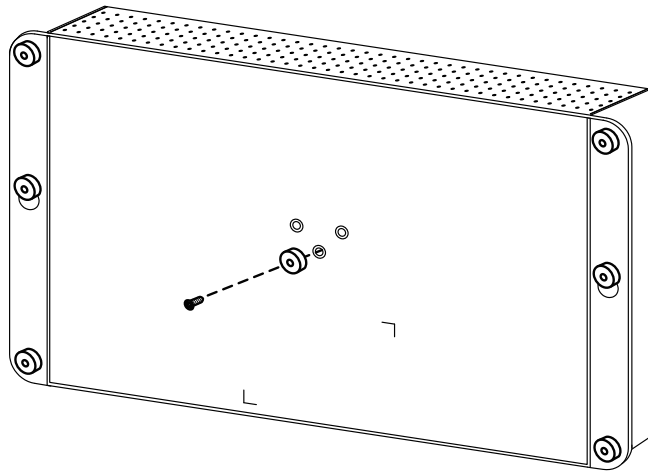

Step 4: Now you can place the switch on to any magnetic surface.



Caution

Make sure magnetic mounting is securely fixed, so that the switch will not drop or break due to vibration.



Note

Please use the screw from the magnet kit to avoid breaking the device.

4.3 DIN-rail Mounting

The DIN-rail kit is included in the package for wall mounting. Refer to the following figures to screw the DIN-rail on the Wall-mount Managed Switch. To hang up the Wall-mount Managed Switch, follow the steps below:

Step 1: Screw the DIN-rail on the Wall-mount Managed Switch.

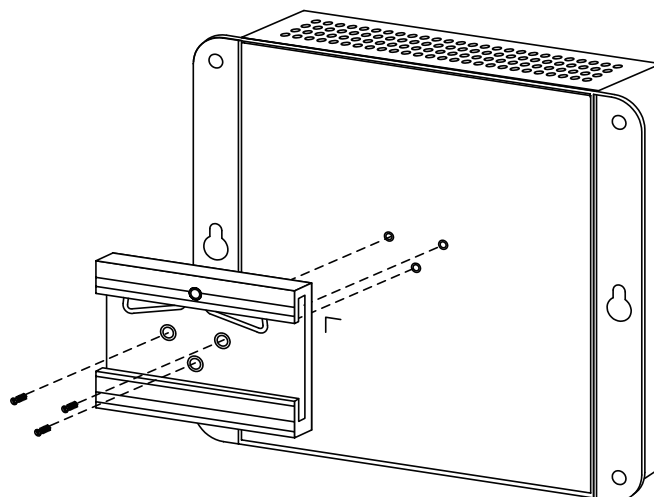

Step 2: Lightly insert the DIN-rail into the track.

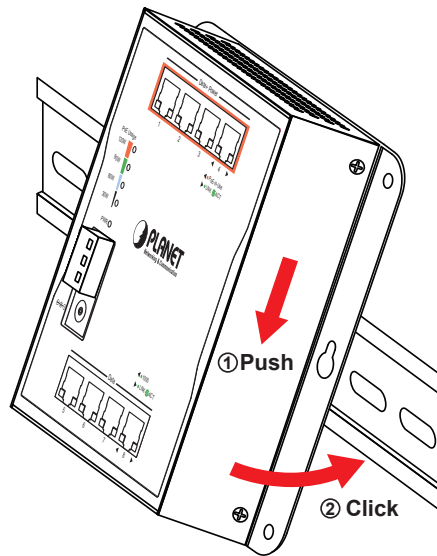

Step 3: Check whether the DIN-rail is tightly on the track.

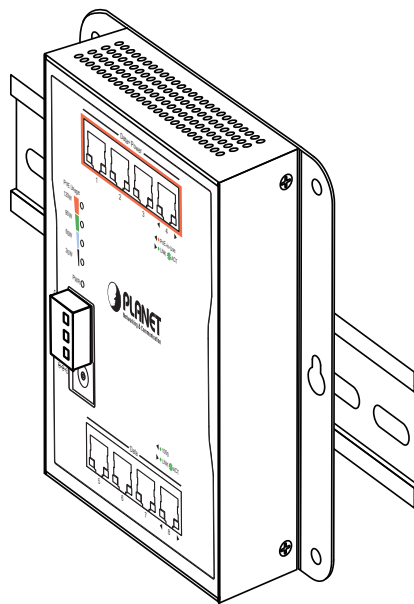

5. Web Login

5.1 Starting Web Management

The following shows how to start up the **Web Management** of the Wall-mount Managed Switch. Note the Wall-mount Managed Switch is configured through an Ethernet connection. Please make sure the manager PC must be set to the same **IP subnet address**.

For example, the default IP address of the Wall-mount Managed Switch is **192.168.0.100**, then the manager PC should be set to **192.168.0.x** (where x is a number between 1 and 254, except 100) and the default subnet mask is 255.255.255.0.

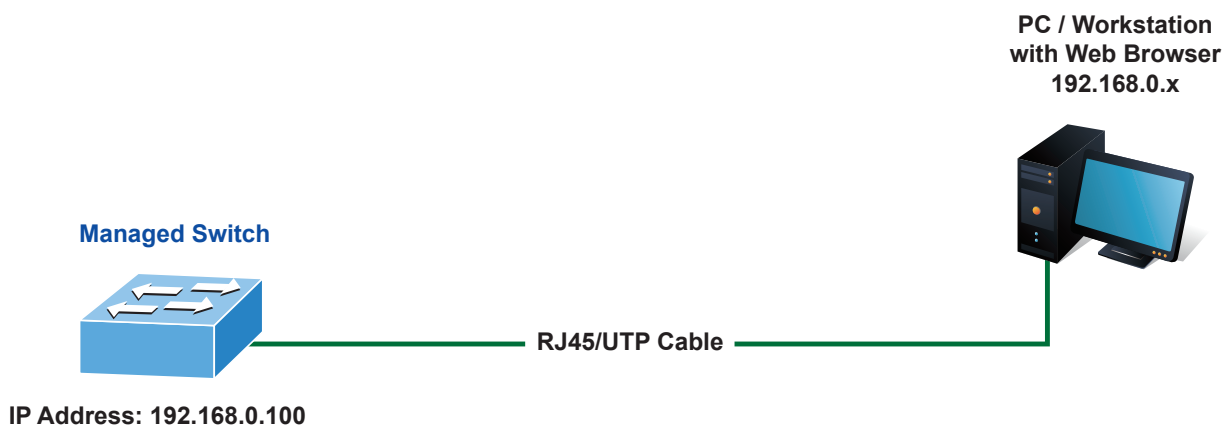

Figure 5-1: IP Management Diagram

Logging in to the Wall-mount Managed Switch

1. Use Google Chrome or above Web browser and enter IP address **<https://192.168.0.100>** to access the Web interface.



Note

The following web screen is based on the firmware version before **February of 2024**.

2. When the following dialog box appears, please enter "**admin**" in both the default user name and password fields. The login screen in Figure 5-2 appears.

Default IP Address: **192.168.0.100**

Default Username: **admin**

Default Password: **admin**

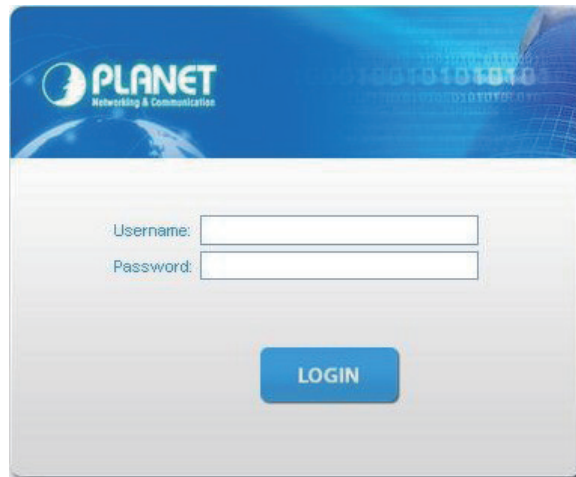

Figure 5-2: Web Login Screen

3. After entering the password, the main screen appears as Figure 5-7 shows.



Note

The following web screen is based on the firmware version of **February of 2024 or after**.

1. When the following dialog box appears, please enter the default user name **"admin"** and password. Refer to following to determine your initial login password.

Default IP Address: **192.168.0.100**

Default User Name: **admin**

Default Password: **sw + the last 6 characters of the MAC ID in lowercase**

2. Find the MAC ID on your device label. The default password is "sw" or "mc" followed by the last six lowercase characters of the MAC ID.

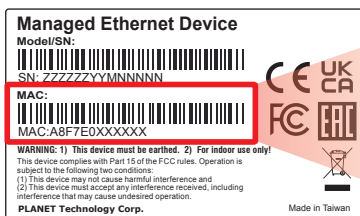

MAC ID: A8F7E0XXXXXX

Default Password: swXXXXXX

("x" means the last 6 digits of the MAC address.

All characters should be in lowercase.)

Figure 5-3: Industrial Managed Switch MAC ID Label

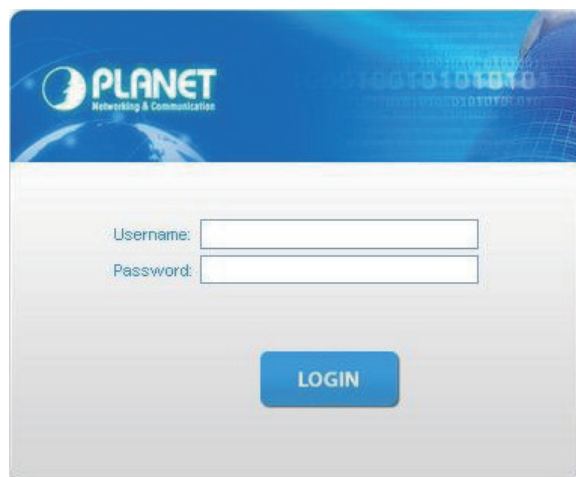
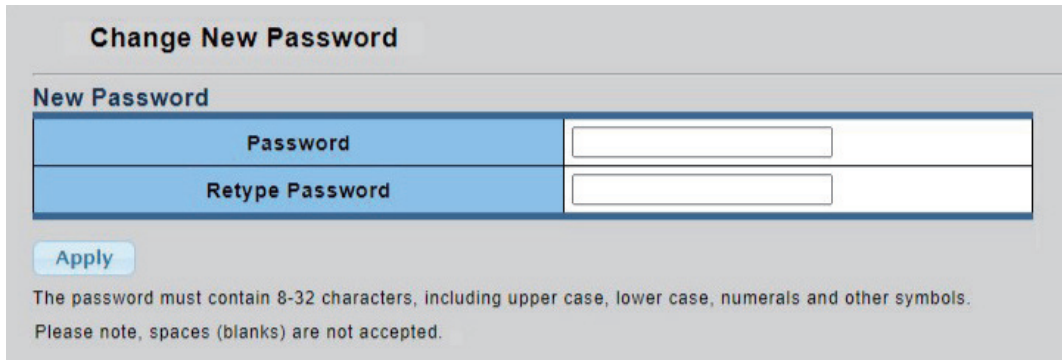

Figure 5-4: Web Login Screen

3. After logging in, you will be prompted to change the initial password to a permanent one.



Change New Password

New Password

Password	<input type="text"/>
Retype Password	<input type="text"/>

Apply

The password must contain 8-32 characters, including upper case, lower case, numerals and other symbols.
Please note, spaces (blanks) are not accepted.

Figure 5-5: Create a New Password

4. Enter the default username and password, then set a new password according to the rule-based prompt and confirm it. Upon success, press any key to return to the login prompt. Log in with **"admin"** and the **"new password"** to access the Web interface.

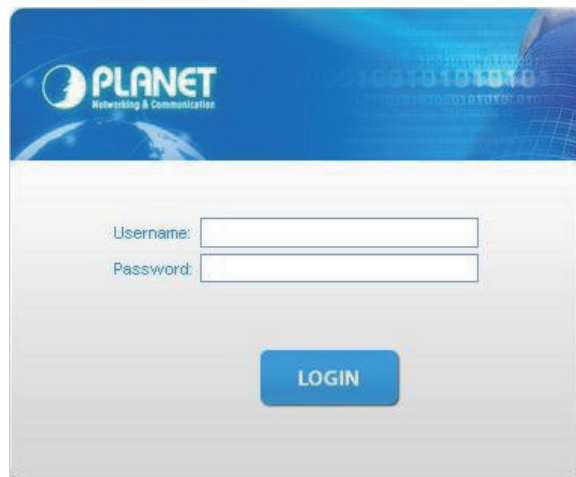

PLANET
Network & Communication

Username:

Password:

LOGIN

Figure 5-6: Web Login with New Password



Note

The following web screen is based on the WGS-4215-8T2S. The display of the WGS-4215-8T2S is the same as those of wall-mount Managed Switch.



Figure 5-7: Web Main Screen of Wall-mount Managed Switch

The Switch Menu on the top of the Web page lets you access all the commands and statistics the Industrial Managed Switch provides. The Switch Menu always contains one or more buttons, such as **"System"**, **"Switching"**, **"QoS"**, **"Security"**, **"Ring"** and **"Maintenance"**.



Figure 5-8: Switch Menu



Figure 5-9: Switch Sub-menu



Figure 5-10: Switch Sub-menu

Now, you can use the Web management interface to continue the Switch management. Please refer to the user’s manual for more.

5.2 Saving Configuration via the Web

In the Wall-mount Managed Switch, the running configuration file stores in the RAM. In the current version, the running configuration sequence of running-config can be saved from the RAM to FLASH by **“Save Configurations to FLASH”** function, so that the running configuration sequence becomes the startup configuration file, which is called configuration save.

To save all applied changes and set the current configuration as a startup configuration, the startup-configuration file will be loaded automatically across a system reboot.

1. Click **“Save > Save Configurations to FLASH”** to log in **“Configuration Manager”** Page.

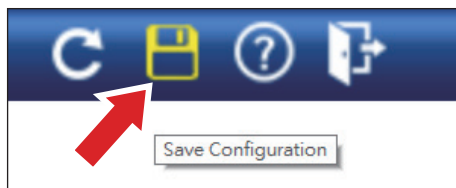

2. Press the **“Apply”** button to save running configuration to start up configuration.

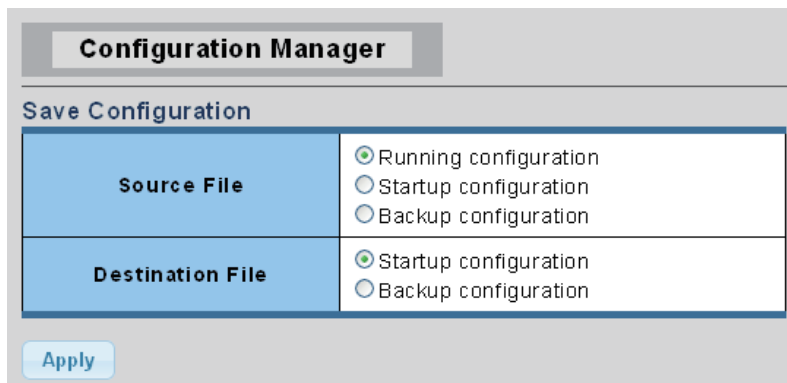

6. SSH Login

The Wall-mount Managed Switch also supports SSHv2 for remote management. The switch asks for user name and password for remote login when using SSHv2 client software; please use the default username and password. Refer to **5.1 Starting Web Management** to determine your initial login password.



Note

The following web screen is based on the firmware version before **February of 2024**.

Default IP Address: **192.168.0.100**

Default Username: **admin**

Default Password: **admin**

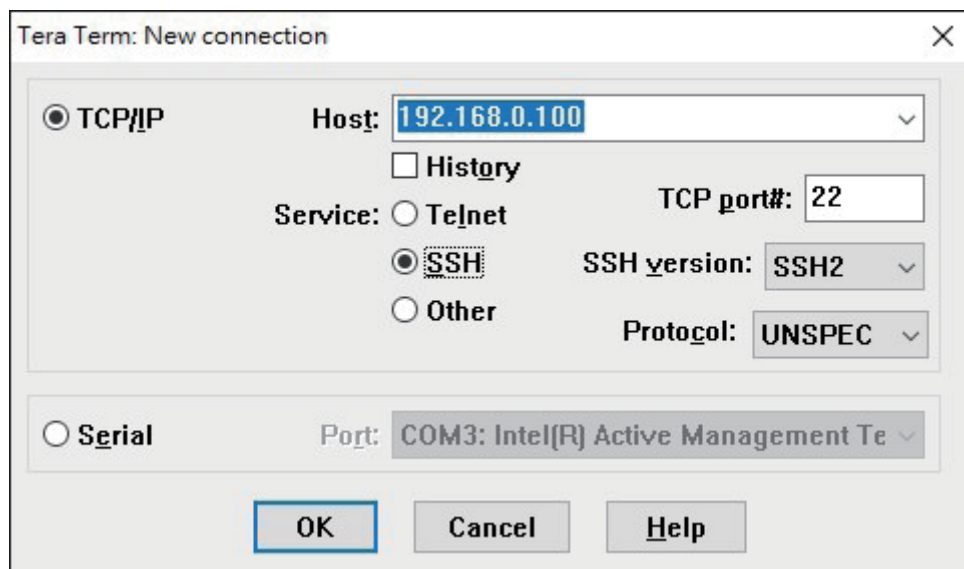

```
Username: admin
Password: *****
WGS-4215-16P2S#
```

Figure 6-1: Wall-mount Managed Switch SSH Login Screen



Note

The following web screen is based on the firmware version of **February of 2024 or after**.

Default IP Address: **192.168.0.100**

Default Username: **admin**

Default Password: **sw + the last 6 characters of the MAC ID in lowercase**

Find the MAC ID on your device label. The default password is "sw" followed by the last six lowercase characters of the MAC ID.

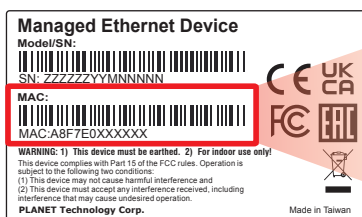

MAC ID: A8F7E0XXXXXX

Default Password: swxxxxxx

("x" means the last 6 digits of the MAC address.
All characters should be in lowercase.)

Figure 6-2: Managed Switch MAC ID Label

Enter the default username and password, then set a new password according to the rule-based prompt and confirm it. Upon success, press any key to return to the login prompt. Log in with "**admin**" and the "**new password**" to access the CLI.

```
(New)Password: *****
Verify (New)Password: *****
Success.
Press any key to continue
Username: admin
Password: *****
IGS-4215-8UP4X# █
```

Figure 6-3: Create a New Password and Login Again

The user can now enter commands to manage the Wall-mount Managed Switch. For a detailed description of the commands, please refer to the following chapters.



Note

1. For security reason, **please change and memorize the new password after this first setup**.
2. Only accept command in lowercase letter under console interface.

6.1 Configuring IP Address

The Wall-mount Managed Switch is shipped with default IP address shown below:

```
IP Address: 192.168.0.100  
Subnet Mask: 255.255.255.0
```

To check the current IP address or modify a new IP address for the Switch, please use the procedure as follows:

■ Display of the Current IP Address

1. At the “#” prompt, enter “**show ip**”.
2. The screen displays the current IP address shown in Figure 6-4.

```
Username: admin  
Password: *****  
WGS-4215-16P2S# show ip  
IP Address: 192.168.0.100  
Subnet Netmask: 255.255.255.0  
Default Gateway: 192.168.0.254  
WGS-4215-16P2S#
```

Figure 6-4: IP Information Screen

■ Configuration of the IP Address

3. At the “#” prompt, enter the following command and press **<Enter>** as shown in Figure 6-5.

```
WGS-4215-16P2S# configure  
WGS-4215-16P2S(config)# ip address 192.168.1.100 mask 255.255.255.0  
WGS-4215-16P2S(config)# ip default gateway 192.168.1.254
```

The previous command would apply the following settings for the Wall-mount Managed Switch.

```
IP Address: 192.168.1.100  
Subnet Mask: 255.255.255.0  
Gateway: 192.168.1.254
```

```
Username: admin  
Password: *****  
WGS-4215-16P2S# configure  
WGS-4215-16P2S(config)# ip address 192.168.1.100 mask 255.255.255.0  
WGS-4215-16P2S(config)# ip default-gateway 192.168.1.254  
WGS-4215-16P2S(config)#
```

Figure 6-5: Configuring IP Address Screen

4. Repeat step 1 to check if the IP address has changed.

6.2 Storing the Current Switch Configuration

At the “#” prompt, enter the following command and press **<Enter>**.

```
# copy running-config startup-config
```

```
Username: admin
Password: ****
WGS-4215-16P2S# copy running-config startup-config
Success
WGS-4215-16P2S# _
```

Figure 6-6: Saving Current Configuration Command Screen

If the IP is successfully configured, the Wall-mount Managed Switch will apply the new IP address setting immediately. You can access the Web interface of the Wall-mount Managed Switch through the new IP address.



Note

If you are not familiar with the Telnet command or the related parameter, enter “?” anytime in console to get the help description.

7. Recovering Back to Default Configuration

■ IP Address has been changed or admin password has been forgotten –

To reset the IP address to the default IP Address "192.168.0.100" and the user name password to factory default mode (default password is admin or sw + the last 6 characters of the MAC ID in lowercase), press the **reset button** on the front panel for about **5 seconds**. After the device is rebooted, you can log in the Web interface management within the same subnet of 192.168.0.xx.

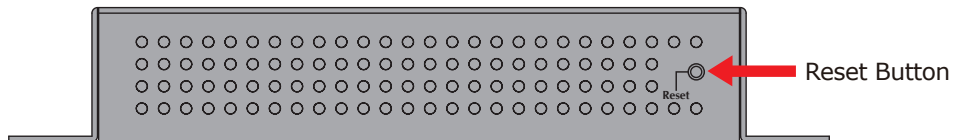

Figure 7-1: WGS-804HPT/WGS-4215-8T Reset Button

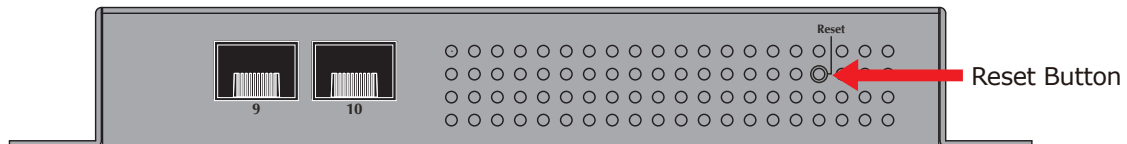

Figure 7-2: WGS-4215-8T2S/WGS-4215-8P2S Reset Button

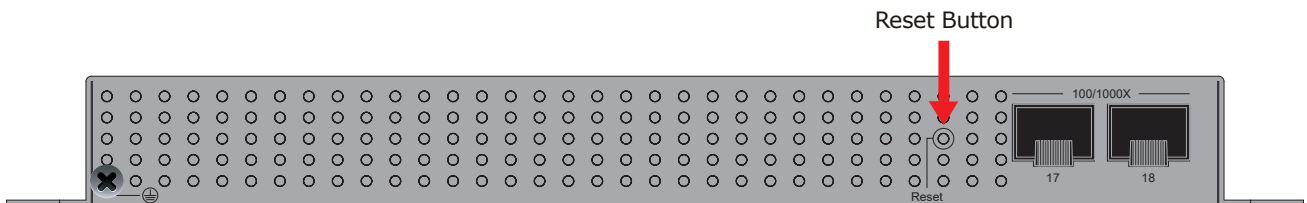

Figure 7-3: WGS-4215-16P2S Reset Button

8. Customer Support

Thank you for purchasing PLANET products. You can browse our online FAQ resource and User's Manual on PLANET Web site first to check if it could solve your issue. If you need more support information, please contact PLANET switch support team.

PLANET online FAQs:

<https://www.planet.com.tw/en/support/faq>

Switch support team email address:

support@planet.com.tw

WGS-804HPT/WGS-4215-8T/WGS-4215-8T2S/WGS-4215-8P2S/WGS-4215-16P2S

User's Manual:

<https://www.planet.com.tw/en/support/downloads?&method=keyword&keyword=WGS&view=3#list>



Copyright © PLANET Technology Corp. 2024.

Contents are subject to revision without prior notice.

PLANET is a registered trademark of PLANET Technology Corp.

All other trademarks belong to their respective owners.