

**Industrial 4-Port 10/100/1000BASE-T 802.3bt PoE + 2-Port
10/100/1000T + 2-Port 100/1000X SFP Ethernet Switch**

IGS-824UPT
User's Manual

Table of Contents

1. Package Contents.....	3
2. Product Specifications	4
3. Hardware Introduction	6
3.1 Switch Front Panel	6
3.2 LED Indicators.....	7
3.3 Switch Upper Panel.....	9
3.4 Wiring the Power Inputs.....	9
3.5 Wiring the Fault Alarm Contact	11
3.6 Grounding the Device.....	11
4. Installation	12
4.1 DIN-rail Mounting Installation	12
4.2 Wall-mount Plate Mounting	13
Customer Support.....	14







1. Package Contents

Thank you for purchasing PLANET IGS-824UPT Industrial 8-Port Gigabit Ethernet Switch with 4-Port PoE++. The interfaces of this model are shown below:

Model Name	10/100/1000T RJ45 Port	100/1000X SFP Slot	PoE Port
IGS-824UPT	6	2	4

In the following section, the term **“Industrial PoE++ Switch”** means the IGS-824UPT.

Open the box of the Industrial PoE++ Switch and carefully unpack it. The box should contain the following items:

Industrial PoE++ Switch x 1	User’s Manual x 1	DIN-rail Kit x 1
		
Wall-mount Kit x 1	RJ45 Dust Cap x 6	SFP Dust Cap x 2
		

If any of these are missing or damaged, please contact your dealer immediately.

2. Product Specifications

Model	IGS-824UPT
Hardware Specifications	
Copper Ports	6 10/100/1000BASE-T RJ45 auto-MDI/MDI-X ports
SFP Slots	2 1000BASE-SX/LX/BX SFP interfaces Compatible with 100BASE-FX SFP
Connector	Removable 6-pin terminal block Pin 1/2 for Power 1 Pin 3/4 for fault alarm Pin 5/6 for Power 2
Alarm	One relay output for power failure. Alarm relay current carry ability: 1A@DC 24V
Power Requirements	48~54V DC, 5A (max.) Redundant power with reverse polarity protection function
Power Consumption	Max. 3.24 watt/11.06 BTU (Idle) Max. 250 watt/853.04 BTU (Full load)
Dimensions (W x D x H)	55 x 85 x 135 mm
Weight	777g
Enclosure	IP30 aluminum case
Installation	DIN-rail kit and wall-mount kit
ESD Protection	6KV
Switch Specifications	
Switch Architecture	Store-and-Forward
Switch Fabric	16Gbps
Throughput (packet per second)	11.9Mpps@64bytes
Address Table	4K entries
Buffer Memory	4M bits on-chip buffer memory
Jumbo Frame	9K bytes

Flow Control	Back pressure for half duplex IEEE 802.3x pause frame for full duplex
Power over Ethernet	
PoE Standard	IEEE 802.3bt PoE++ type 4 PSE Backward compatible with IEEE 802.3at PoE+ PSE
PoE Power Supply Type	802.3bt Legacy/Force End-span/Mid-span
PoE Power Output	Max. 95 watts to 802.3bt PoE++ PD Max. 95 watts to Legacy/Force PD Max. 36 watts to 802.3at PoE+ PD
Power Pin Assignment	End-span: 1/2(-), 3/6(+) Mid-span: 4/5(+), 7/8(-) 802.3bt/PoH: 1/2(-), 3/6(+), 4/5(+), 7/8(-)
PoE Power Budget	240 watts maximum@52-54V DC input 160 watts maximum@48-51V DC input
Standard Conformance	
Regulatory Compliance	FCC Part 15 Class A, CE
Stability Testing	IEC 60068-2-32 (free fall) IEC 60068-2-27 (shock) IEC 60068-2-6 (vibration)
Standards Compliance	IEEE 802.3 Ethernet IEEE 802.3u Fast Ethernet IEEE 802.3ab Gigabit Ethernet IEEE 802.3z Gigabit SX/LX IEEE 802.3x Full-Duplex Flow Control IEEE 802.3az Energy Efficient Ethernet (EEE) IEEE 802.3bt Power over Ethernet Plus Plus IEEE 802.3at Power over Ethernet Plus PSE IEEE 802.1p Class of Service
Environment	
Temperature	Operating: -40~75 degrees C Storage: -40~75 degrees C
Humidity	Operating: 5~90% (non-condensing) Storage: 5~90% (non-condensing)

3. Hardware Introduction

3.1 Switch Front Panel

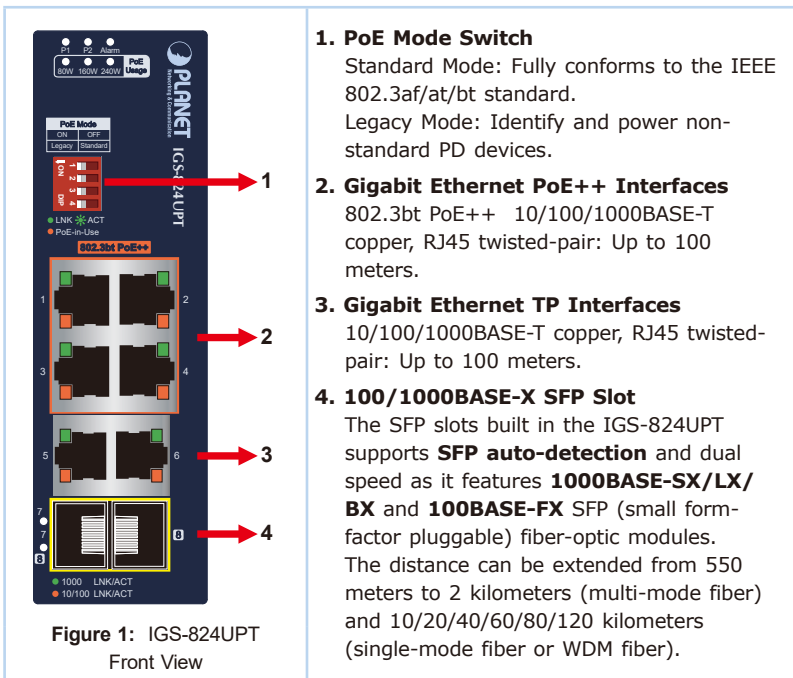

Details of PoE Mode

PoE Mode	Description
Standard (Default)	The Standard mode is to provide power to the PD device that follows the IEEE 802.3af/at/bt standard.
Legacy	The Legacy mode supports Ultra PoE. It is to provide power to the PD devices that do not fully follow the IEEE 802.3af/at/bt standard.



Caution

The IGS-824UPT also supports Force Power Mode in the Legacy mode. If the output power of IGS-824UPT in the Legacy Mode is less than 1 watt for 20 seconds, the Force Mode will be enabled for 2 seconds. If the loading is still less than 1 watt, the Legacy Mode will be enabled again.



Warning

The IGS-824UPT in the Force Mode will also provide a maximum 95-watt power to the PD. TO PREVENT THE DEVICES FROM DAMAGE, please make sure the remote devices supports either the Legacy or Force Mode before turning the DIP switch to the Legacy Mode.



Note

Only adjust the DIP switch to the desired mode before powering on the IGS-824UPT. Power off first before changing mode.

3.2 LED Indicators

> System

LED	Color	Function
P1	Green	Lights to indicate power 1 has power.
P2	Green	Lights to indicate power 2 has power.
Alarm	Red	Lights to indicate either power 1 or power 2 has no power.

> PoE Power Usage (Unit: Watt)

LED	Color	Function
80W	Amber	Blinks to indicate that the PoE usage is around 40W to 79W. Lights to indicate the PoE usage is around/over 80W.
160W	Amber	Blinks to indicate that the PoE usage is around 120W to 159W. Lights to indicate the PoE usage is around/over 160W.
240W	Amber	Blinks to indicate that the PoE usage is around 200W to 239W. Lights to indicate the PoE usage is at the maximum.

➤ **Per 802.3bt PoE++ 10/100/1000BASE-T Interface (Port 1 to Port 4)**

LED	Color	Function
LNK/ACT	Green	<p>Lights to indicate the link through that port is successfully established at 10Mbps or 100Mbps or 1000Mbps.</p> <p>Blinks to indicate that the Switch is actively sending or receiving data over that port.</p>
PoE-in-Use	Amber	<p>Lights to indicate the port is providing DC in-line power.</p> <p>Off to indicate the connected device is not a PoE powered device (PD).</p>

➤ **Per 10/100/1000BASE-T Interface (Port 5 and Port 6)**

LED	Color	Function
1000 LNK/ACT	Green	<p>Lights to indicate the port is successfully established at 1000Mbps.</p> <p>Blinks to indicate that the Switch is actively sending or receiving data over that port.</p>
10/100 LNK/ACT	Amber	<p>Lights to indicate the port is successfully established at 100Mbps or 10Mbps.</p> <p>Blinks to indicate that the Switch is actively sending or receiving data over that port.</p>

➤ **Per 1000BASE-X SFP Slot (Port 7 and Port 8)**

LED	Color	Function
1000 LNK/ACT	Green	<p>Lights to indicate the port is successfully established at 1000Mbps.</p> <p>Blinks to indicate that the Switch is actively sending or receiving data over that port.</p>
100 LNK/ACT	Amber	<p>Lights to indicate the port is successfully established at 100Mbps</p> <p>Blinks to indicate that the Switch is actively sending or receiving data over that port.</p>

3.3 Switch Upper Panel

The upper panel of the Industrial PoE++ Switch consists of one terminal block connector within two DC power inputs.

Figure 3-2 shows the upper panel of the Industrial PoE++ Switch.

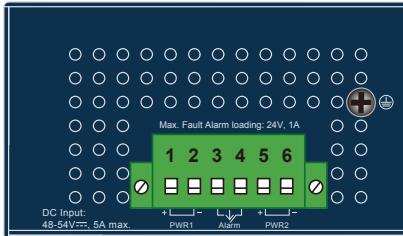

Figure 3-2: Industrial PoE++ Switch Upper Panel

3.4 Wiring the Power Inputs

The 6-contact terminal block connector on the top panel of Industrial PoE++ Switch is used for two DC redundant power inputs. Please follow the steps below to insert the power wire.



When performing any of the procedures like inserting the wires or tightening the wire-clamp screws, make sure the power is OFF to prevent from getting an electric shock.

1. The DC power input range is **48V ~ 54V DC**. Please insert positive and negative DC power wires into contacts 1 and 2 for POWER 1, or 5 and 6 for POWER 2.

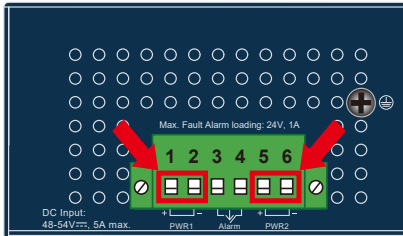

Figure 3-3: Industrial PoE++ Switch DC Input

DC Input	Max. PoE Budget
48~51V	160W
52V~54V	240W



Note

1. To avoid damage, please use the Industrial PoE++ Switch according to its specifications.
2. Please follow the table above for DC input in relation with maximum PoE budget.

2. Tighten the wire-clamp screws for preventing the wires from loosening.

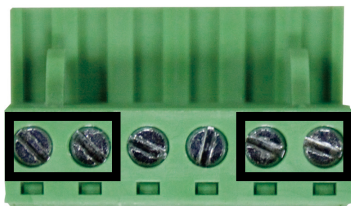

1	2	3	4	5	6
Power 1		Alarm		Power 2	
+	-			+	-



Note

The wire gauge for the terminal block should be in the range between 12 and 24 AWG.



Caution

PWR1 and PWR2 must provide exactly the **same DC voltage** for power load balance while operating with dual power input.

3.5 Wiring the Fault Alarm Contact

The fault alarm contacts are in the middle of the terminal block connector as the picture shows below. Inserting the wires, the Industrial PoE++ Switch will detect the fault status of the power failure and then forms an open circuit. The following illustration shows an application example for wiring the fault alarm contacts.

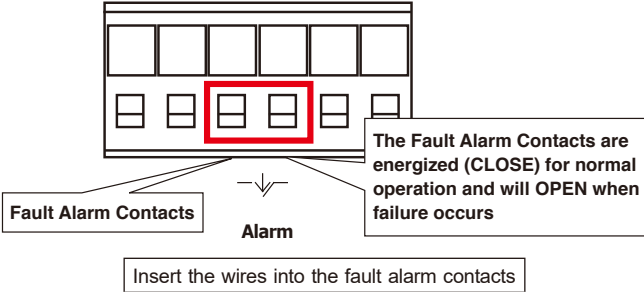

Note

1. The wire gauge for the terminal block should be in the range between 12 and 24 AWG.
2. Alarm relay circuit accepts up to 24V, max. 1A currents.

3.6 Grounding the Device

Users **MUST** complete grounding wired with the device; otherwise, a sudden lightning could cause fatal damage to the device.

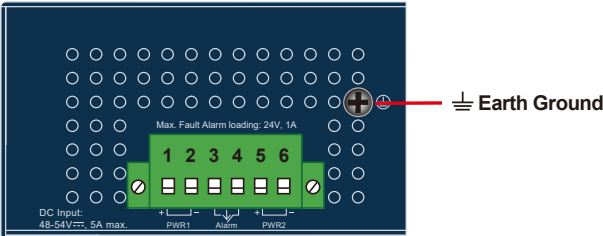

Note

EMD (Lightning) DAMAGE IS NOT COVERED UNDER WARRANTY.

4. Installation

This section describes the functionalities of the Industrial PoE++ Switch's components and guides you to installing it on a DIN-rail and wall. Basic knowledge of networking is assumed. Please read this chapter completely before continuing.



Note

The following pictures show how to install the device although the device in the picture is not IGS-824UPT.

4.1 DIN-rail Mounting Installation

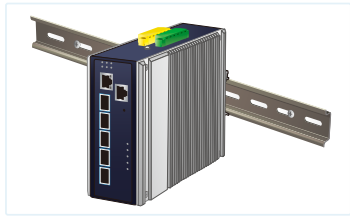
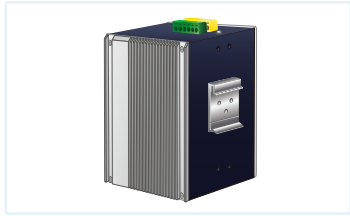
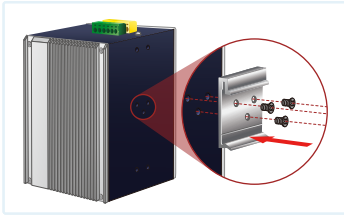

4.2 Wall-mount Plate Mounting

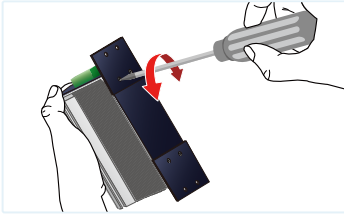

The above picture are for illustration only.



Caution

You must use the screws supplied with the wall-mounting brackets. Damage caused to the parts by using incorrect screws would invalidate your warranty.

Customer Support

Thank you for purchasing PLANET products. You can browse our online FAQ resource at the PLANET Web site first to check if it could solve your issue. If you need more support information, please contact PLANET support team.

PLANET online FAQs:

<https://www.planet.com.tw/en/support/faq>

Support team mail address:

support@planet.com.tw

Copyright © PLANET Technology Corp. 2023.

Contents are subject to revision without prior notice.

PLANET is a registered trademark of PLANET Technology Corp.

All other trademarks belong to their respective owners.

FCC Warning

This device has been tested and found to comply with the limits for a Class A digital device, pursuant to Part 15 of the FCC Rules. These limits are designed to provide reasonable protection against harmful interference when the equipment is operated in a commercial environment. This equipment generates, uses, and can radiate radio frequency energy and, if not installed and used in accordance with the Instruction manual, may cause harmful interference to radio communications. Operation of this equipment in a residential area is likely to cause harmful interference in which case the user will be required to correct the interference at his own expense.

WEEE Warning



To avoid the potential effects on the environment and human health as a result of the presence of hazardous substances in electrical and electronic equipment, end users of electrical and electronic equipment should understand the meaning of the crossed-out wheeled bin symbol. Do not dispose of WEEE as unsorted municipal waste and have to collect such WEEE separately.