

**7" Smart Media Android SIP Conference Phone with
Full HD Camera and Touch Screen**

ICF-2000

Quick Installation Guide







Table of Contents

1. Package Contents	3
2. Panel Introduction.....	4
3. Hardware Installation and Login.....	5
4. Further Information	10

1. Package Contents







VERIFY THE CONTENTS INSIDE THE PACKAGE BOX

The package should contain the following items plus ICF-2000. If any item is missing or damaged, please contact the seller immediately.

ICF-2000	Quick Installation Guide	Handset
		
Handset Cord	Stand	RJ45 Cable
		

2. Panel Introduction

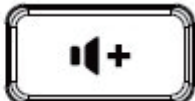
Key features

Features	Description
	Message waiting indicator
	Home key: Return to standby home page
	Return key: Return to the previous menu or page
 	The ringer volume can be increased or decreased according to your acceptable volume when using an earpiece, headset or hands-free phone.
	Hands-free key is to activate or deactivate hands-free mode

3. Hardware Installation and Login

Step 1. Installing the phone

Please follow the instructions below to install the phone.

- Desktop – Attach the stand to the holes on the back of the phone to prop it up on the desk.

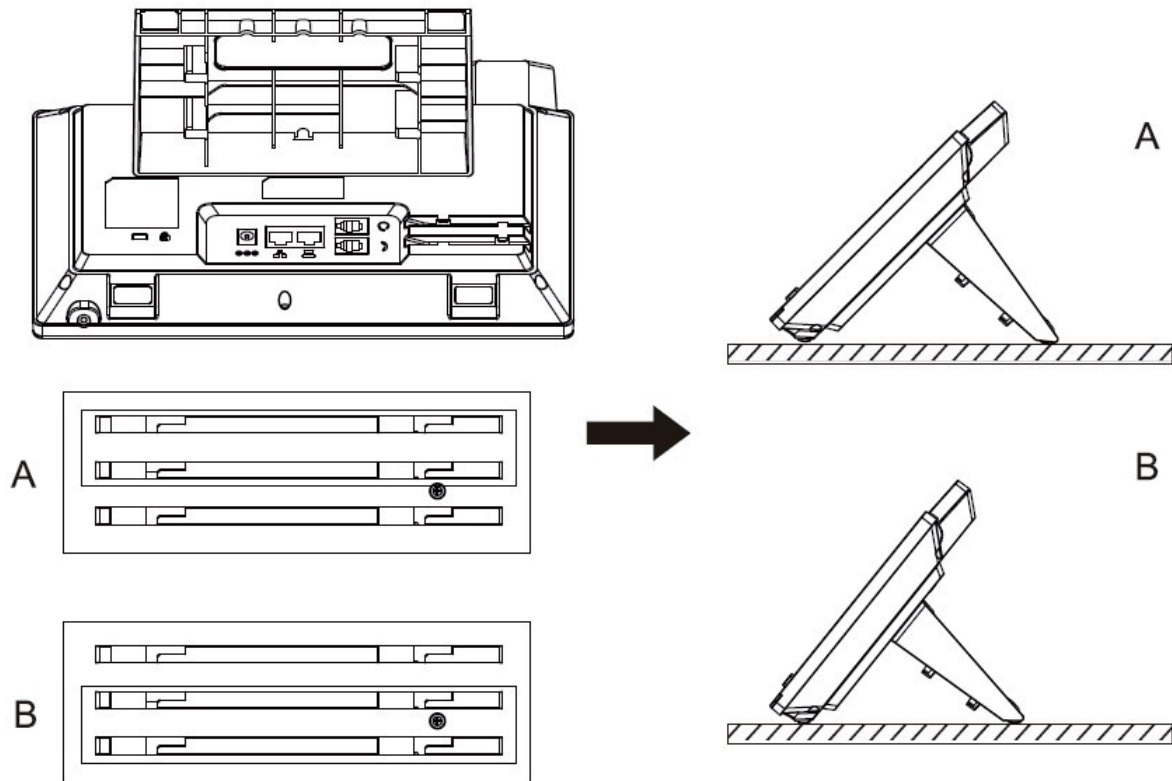

- Wall mounting – Attach the stand to the holes on the back of the phone as if it were secured to the back of the device. Get a couple of hooks and hammer them into a wall. Then hang the phone on the wall with the help of the hooks.

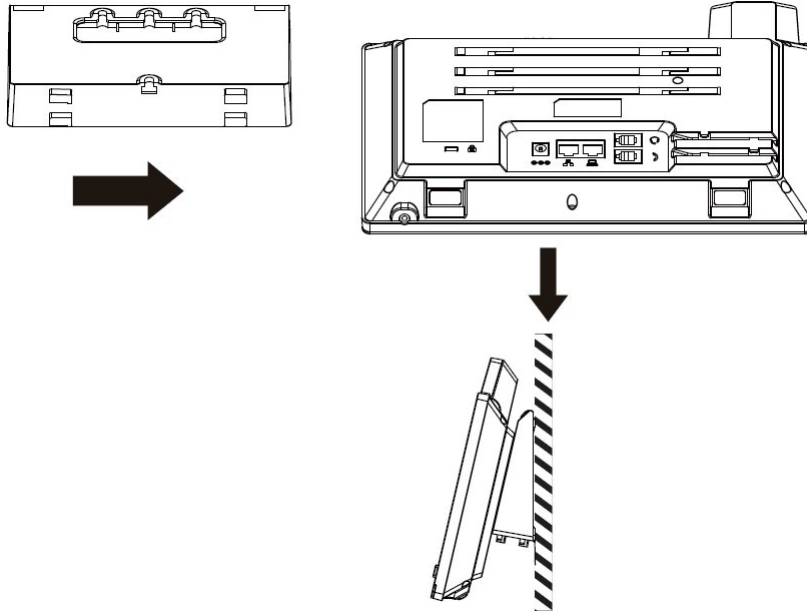

Step 2. Connecting to the phone

1. Connect to the corresponding ports as described in the diagram below.

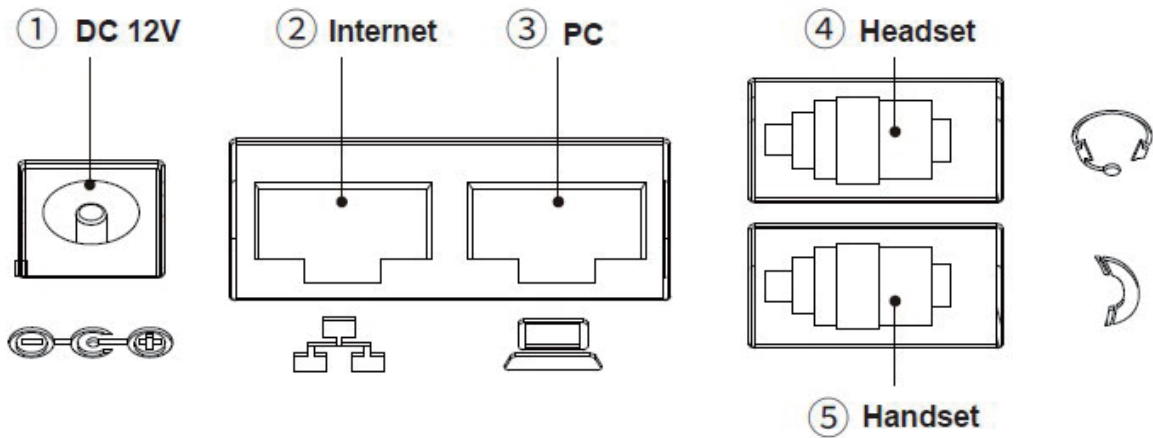

Index	Interface	Description
1	Power port	Connected with a 12V DC, 1A adapter.
2	Internet port	Connect to the Internet. (The Internet port supports PoE, allowing it to connect to an IEEE802.3at PSE device, such as 802.3at injector, hub or 802.3at PoE switch.)
3	PC port	Connect to the computer.
4	Headset port	Connected with an RJ9 cable for headset use.
5	Handset port	Connected with an RJ9 cable for IP phone handset use.



Note

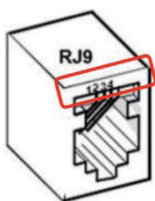

Headset pinout:

1. MIC-
2. SPK+
3. SPK-
4. MIC+

Step 3. Camera information

Turn the knob to adjust the camera angle. The knob can rotate 15 degrees.

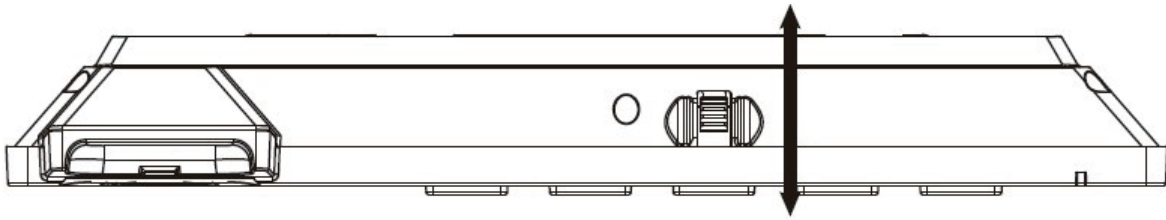

Step 4. Computer Network Setup

Set your computer's IP address to 192.168.0.x, where x is a number between 2 and 254 (except 1 where is being used for the phone by default). If you don't know how to do this, please ask your network administrator.

Step 5. Login Prompt

Use Web browser (Google Chrome or Microsoft Edge) to connect to **192.168.0.1** (Type this address in the address bar of Web browser.)

You'll be prompted to input user name and password: **admin** and **123**.



Step 6. Change of Password

After logging in, you will be prompted to change the initial password to a permanent one.

The length of the password should not be less than 8 digits and should include numerals, uppercase and letters, and special characters.

Change Web Authentication Password

Username	admin
Old Password:	<input type="password"/>
New Password:	<input type="password"/>
Confirm Password:	<input type="password"/>
	<input type="button" value="Apply"/>

Warning

The length of the password shall not be less than 8 digits and shall include numerals, uppercase letters, lowercase letters and special characters.

4. Further Information

The above steps introduce the simple installations of the device. For further details, please refer to the user manual, which can be downloaded from the website.



<https://www.planet.com.tw/en/support/downloads?&method=keyword&keyword=ICF-2000&view=3#list>

Energy Saving Note of the Device

This power required device does not support Standby mode operation. For energy savings, please remove the DC plug or slide the hardware-based Power Switch to the OFF position to disconnect the device from the power circuit. Without removing the DC plug from or switching off the device, the device will still consume power from the power source. In view of Saving the Energy and reducing the unnecessary power consumption, it is strongly suggested to power off or to remove the DC plug from the device if this device is not intended to be active.